

WELCOME TO HENDI'S DIGITAL CATALOGUE

FRIENDLY/ FUNCTIONAL/ ECOLOGICAL

+ EASY TO NAVIGATE



+ CLICK THE REGISTER TO GO TO THE CHAPTER



+ EASY AND POWERFULL SEARCH FUNCTION



+ MORE INFO ABOUT THE PRODUCT /
PICTURES / VIDEOS



+ CREATE YOUR OWN CATALOGUE



+ SHARE WITH A CLICK





HENDI

2023/2024 | Tools for Chefs

POTS, PANS & GN CONTAINERS



KITCHEN TOOLS



CREAM WHIPPERS & PASTRY



FOOD PROCESSING



VACUUM PACKING



THERMAL PROCESSING



CONVECTION OVENS



PIZZA, PASTA & KEBAB



COOLING



TRANSPORT



FURNITURE



HYGIENE



TABLEWARE



BUFFET PRODUCTS



BAR & COLD DRINKS



HOT DRINKS



BARBECUES & HEATERS



Also available online

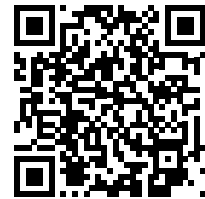



HENDI

Tools for Chefs

Professional Tools for Chefs

Catalogue **2023|2024**

September 2023

For the latest price information consult our digital catalogue on www.hendi.eu or consult your dealer.
Our General Terms and Conditions of Sale, Delivery & Payment, as registered with the Chamber of Commerce of Utrecht with Reference 30053484, apply to all transactions. A copy of these terms will be made available free of charge upon first request.

HENDI

Your needs - our tools

Choose the best-in-class #toolsforchefs!

We've got the best tools for the horeca and food service industry. We always strive to offer professional equipment of high-level quality. Our global strategy and almost 90 years of experience helped us build an assortment that follows the latest trends but is also influenced by your needs. We are where the chefs need us. We're constantly evolving to stay a reliable partner for your business.

This catalogue includes over 3.000 products, including lots of novelties and best-sellers. We're proud that chefs from all over the world use our tools on a daily basis and trust them to build their business.





HENDI

Tools for Chefs



Watch our
company movie

HENDI The Netherlands

Innovatielaan 6, 6745 XW
De Klomp, The Netherlands
T: +31 (0)317 68 10 40
F: +31 (0)317 68 10 45
info@hendi.eu
www.hendi.eu

HENDI Austria

Gewerbegebiet Ehring 15
5112 Lamprechtshausen, Austria
T: +43 (0)6274 200 10 0
F: +43 (0)6274 200 10 20
office.austria@hendi.eu
www.hendi.com

HENDI Poland

ul. Firmowa 12,
62-023 Robakowo, Polska
T: +48 61 658 70 00
F: +48 61 658 70 01
info@hendi.pl
www.hendi.com

HENDI Greece

5 Metsovou Str.
18346 Moschato, Athens, Greece
T: +30 210 483 97 00
F: +30 210 483 97 10
office.greece@hendi.eu
www.hendi.eu

HENDI Italy

Via Leonardo da Vinci 4,
39100 Bolzano (BZ) Italy
T: 800 727 438
F: +43 (0)6274 200 10 20
office.italy@hendi.eu
www.hendi.it

HENDI Romania

Str. 13 decembrie 94A, Hala 14
Braşov 500164 RO, Romania
T: +40 268 320330
F: +40 268 320335
office@hendi.ro
www.hendi.ro

HENDI Hong Kong

1208, 12/F, Exchange Tower
33 Wang Chiu Road, Kowloon Bay
Hong Kong
info-hk@hendi.eu
www.hendi.eu

HENDI
The Netherlands

HENDI
Austria

HENDI
Greece

HENDI
Italy

HENDI
Poland

HENDI
Romania





On the cover: Carmine de Michele, head chef and owner of “De Michele - verace pizza napoletana”

Sinfully delicious pizza from the heart of Upper Austria



Honest with a touch of exclusivity, that's the gastronomy style Carmine de Michele embodies. In the Austrian restaurant scene you can't get past the head chef and owner of “De Michele - Verace Pizza Napoletana”.

Carmine is far from mainstream and exhibits the essence of Bella Vita. He is Italy in the heart of Austria. This means Italian lifestyle and the country's finest culinary sides alongside gastronomic perfec-

tion and entrepreneurial innovation.

Born in Naples, southern Italy, in 1990, his passion for 'forbidden' tasty pizza renders his hometown great services as a culinary ambassador. Whether through his restaurant “De Michele”, which opened in 2018, “De Michele Catering” or with his mobile Pizza-Ape.

Carmine de Michele's spirit of innovation and willingness to take risks have proven to be a good combination. Carmine participated in the Campionato Mondiale Pizza DOC, receiving the title of Austria's best pizza baker for multiple years and

also being named one of the best pizzaiolos in the world. Rightly so, because with charm and character, he and his team do what they do best: delighting their guests with great dishes, prepared with love and high-quality ingredients. All this within the atmosphere of an Italian enclave in the heart of Upper Austria, making it a special kind of experience.

This requires professionalism, reliability, authenticity, and a strong philosophy. Characteristics that HENDI also embodies and make Carmine de Michele and HENDI an excellent combination and offer anything but dull everyday life.

UNIQ

the new
design classic



Unique buffet presentations with the new chafing dish and soup kettle designed by Robert Bronwasser

Up till now electric chafing dishes and soup kettles have been functional. But, as often with functional products, the design could hardly be described as beautiful and doesn't do justice to the delicious food served from them.



design by
Robert Bronwasser

For over three years HENDI and Robert Bronwasser have been working extensively on this new range. The effort is not only visible in the design but also in functionality.

Notable features

1. The lid guides condensation moisture back into the water container.

2. No more loose lids lying around thanks to the hinged glass lid which is mounted in the container cover.
3. The display keeps track of the total operation time, reducing the risk of having it out too long.
4. And finally, the electric chafing dish and soup kettle are available in 3 colours, black, white and green.



All models
on page

366

Meet HENDI Profi, Kitchen and Budget Line

Each of them fulfills different requirements - it is profiled towards the specific needs of different levels of chefs and cooks.



PROFI LINE

The partner for professionals ideally suited for the most demanding kitchens. Well thought out and solid construction made of the highest quality materials and components. Ready for intensive everyday use. The guarantee of long operation and ease of maintenance translates into lower costs.

KITCHEN LINE

Reliable tools for professional kitchens. Made of standardized materials, high quality at a reasonable price. Intended for regular, balanced use, it guarantees reliable gastronomic results with an energy-saving focus.

BUDGET LINE

When money counts these are our most cost-efficient tools for daily use in professional kitchens. They're made from basic but good materials with a more basic finish. A well-thought-out design - facilitating simple and uncomplicated use.

All lines meet safety standards, come with standard warranty, and are covered by after-sales service.

Always up-to-date!

Our catalogue is also available online with nice features like:

- + powerful search tool
- + easy navigation
- + fast sharing.

But most important of all, **up-to-date prices.**

Scan the QR-code and bookmark the page.



Scan and explore



WELCOME TO HENDI'S DIGITAL CATALOGUE

FRIENDLY/ FUNCTIONAL/ ECOLOGICAL

+ EASY TO NAVIGATE



+ CLICK THE REGISTER TO GO TO THE CHAPTER



+ EASY AND POWERFULL SEARCH FUNCTION



+ MORE INFO ABOUT THE PRODUCT / PICTURES / VIDEOS



+ CREATE YOUR OWN CATALOGUE



+ SHARE WITH A CLICK





20



27



32



37



46



48

POTS, PANS & GN CONTAINERS



50



54



74



86



92



96

KITCHEN TOOLS



104



108



116



123



124



126

CREAM WHIPPERS & PASTRY



128



131



132



134



137



138

FOOD PROCESSING



144



147



147



148



148



149

VACUUM PACKING



151



154



165



171



172



176

THERMAL PROCESSING



210



212



218



221



222



223

CONVECTION OVENS



225



227



228



232



235



237

PIZZA, PASTA & KEBAB



238



241



242



246



251



260

COOLING



262



264



267



269



272



273

TRANSPORT



277



278



279



281



287



287

FURNITURE



288



300



302



307



309



310

HYGIENE



312



317



318



342



355



362

TABLEWARE



367



376



380



387



394



402

BUFFET PRODUCTS



408



415



417



426



428



434

BAR & COLD DRINKS



436



438



441



442



443



444

HOT DRINKS



448



453



454



458



461



463

BARBECUES & HEATERS



Selection of new products for 2023

POTS, PANS & GN CONTAINERS	KITCHEN TOOLS	KITCHEN TOOLS
<p>Cast iron casserole enamelled page 31</p> 	<p>Japanese sharpening stone HENDI by Naniwa page 62</p> 	<p>Garlic press page 63</p> 
<p>KITCHEN TOOLS</p> <p>Chef plating set, 6 pcs, black page 66</p> 	<p>KITCHEN TOOLS</p> <p>Bucket Budget Line page 76</p> 	<p>KITCHEN TOOLS</p> <p>Pressure food sprayer page 78</p> 
<p>KITCHEN TOOLS</p> <p>Bent wooden spatula - set of 2 page 82</p> 	<p>KITCHEN TOOLS</p> <p>Conical strainer with wire mesh, reinforced page 89</p> 	<p>KITCHEN TOOLS</p> <p>Extendable sink colander page 91</p> 

KITCHEN TOOLS

Digital scale up to 200 kg
page 93



KITCHEN TOOLS

Sauce bain-marie with dispenser
page 99



KITCHEN TOOLS

Mini sauce dispenser - set of 4 pcs.
page 100



KITCHEN TOOLS

Milkshake mixer BPA Free - Design by Bronwasser
page 113



rb design by Robert Bronwasser

VACUUM PACKING

Teflon tape for top sealbar
page 147



THERMAL PROCESSING

Pressure regulator 50 mBar
page 153



THERMAL PROCESSING

Salamander GN 1/1 wall mountable
page 190



THERMAL PROCESSING

Nacho warmer
page 195



THERMAL PROCESSING

Popcorn machine
page 197



Selection of new products for 2023

CONVECTION OVENS

Stand for ovens
page 212



PIZZA, PASTA & KEBAB

Perforated pizza pan
page 235



COOLING

Dry aging cabinet
page 247



HYGIENE

Grease trap
page 297



HYGIENE

Pull-out basin tap
page 298



HYGIENE

Round container body
page 304



HYGIENE

Professional grill and oven cleaner
page 307



TABLEWARE

Placemat – set
page 335



TABLEWARE

Wooden pepper mill
page 352



BUFFET PRODUCTS

UNIQ Chafing dish
page 366



BUFFET PRODUCTS

UNIQ Soup kettle
page 367



BUFFET PRODUCTS

Roll Top Display, double-purpose, Single Deck
page 388



BUFFET PRODUCTS

Restaurant calling system
page 407



BAR & COLD DRINKS

Bartender bag
page 416



BAR & COLD DRINKS

Slush machine
page 423



HOT DRINKS

Electric milk frother
page 439



BARBECUES & HEATERS

Grid for Grill master
page 456



BARBECUES & HEATERS

Charcoal Marabu
page 458



INDEX A-Z

50x60 dishwasher for trays and pots - electronically controlled, with detergent dosing system and drain pump ...	296	Beer glass carrier.....	433	Catering chair - light grey.....	406
2-Door pizza cooling table with 7 drawers, with granite worktop.....	245	Beer skimmer.....	433	Catering furniture foldable.....	404
2 lamp infrared food warmer bridge.....	170	Beer tray.....	399	Central work table.....	278
9-piece Knives set.....	57	Bench.....	406	Central work table with a shelf Budget Line - screwed ..	280
3-shelf polypropylene service cart.....	265	Bent wooden spatula - set of 2.....	82	Centrifugal juice extractor.....	425
3-tier glass rimmer.....	416	Big chunks.....	184, 459	Chafing dish electric Pollina.....	369
5 wheel dough cutter.....	119	Bins and ashtray stands.....	305	Chafing dish electric Tellano.....	369
A		Bird's nest shaped strainer.....	74	Chafing dish electric Tesino.....	369
Acrylic pepper mill.....	353	Blackboard markers 15 mm.....	363	Chafing dishes Profi Line.....	372
Acrylic salt grinder.....	353	Blackboard markers 1 mm.....	363	Chafing Dish fuel.....	376-377
Adaptor bar for GN containers.....	38, 41	Blackboard markers 3 mm.....	363	Chafing dish fuel bottle.....	377
Air pot.....	348	Blackboard markers with narrow tip.....	363	Chafing dish fuel bucket.....	377
Aluminium ice scoop.....	431	Blackboards.....	362	Chafing dish fuel can holder - 2 pcs.....	377
Aluminium ice scoop slotted.....	431	Blackboard with easel.....	363	Chafing dish fuel can.....	376
Aluminium scoop.....	77	Blackboard with stand.....	363	Chafing dish fuel jerry can.....	377
Aluminium storage rack.....	274	Blast chiller 3x GN 2/3.....	248	Chafing dish Gastronorm 1/1.....	370-371
Aluminium storage rack for GN containers.....	274	Blast chillers.....	249	Chafing dish Gastronorm 1/2.....	370
Analog kitchen timer.....	98	Blender Jar BPA free.....	143, 427	Chafing dish GN 1/1 mirror finish.....	373
Angled frying spatula.....	82	Blender Jar with titanium coated blade.....	143, 427	Chafing dish GN 1/2 mirror finish.....	373
Anti-slip mat.....	52	Blender shaft for stick blender.....	139	Chafing dish GN 2/3 mirror finish.....	373
Apple corer.....	64	Blender with noise cover.....	142, 426	Chafing dish GN 1/1 satin finish.....	372
Aromatic wood chips.....	182	Bola patio infrared radiant heater.....	464	Chafing dish GN 1/2 satin finish.....	372
Ash collector.....	364	Boston shaker.....	415	Chafing dish GN 2/3 satin finish.....	372
Ashtray.....	364	Boston shaker black.....	415	Chafing dish heater.....	374-375
Ashtrays & ash collector.....	364	Bottle cap perforator.....	411	Chafing dish ladles and serving spoons.....	380
Ashtray with fire rim.....	364	Bottle opener with catcher bin.....	408	Chafing dish - round.....	370
Ashtray with lid - 3 pcs.....	364	Bottle stopper - 3 pcs.....	411	Chafing dish round satin finish.....	372
Ashtray with lower tray.....	364	Bowl ashtray black.....	364	Chafing Dish Set.....	371
Ashtray with push button.....	364	Bowl rectangular.....	326	Champagne cooler.....	417
Asparagus and pasta pan XL.....	25	Bowl Vanilla.....	328	Champagne stopper.....	411
Automatic cleaning system for Nano Drive ovens and their Bakery versions.....	215	Brass & stainless steel wire brush set - 2 pcs.....	461	Channel knife.....	64
Automatic fill boiler.....	443	Bread bag, round.....	346	Charcoal barbecue Patio.....	458
B		Bread bags.....	346	Charcoal barbecue Resto.....	458
Back bar refrigerators.....	256, 434	Bread basket display GN 1/2.....	386	Charcoal barbecues.....	458
Bag rolls attachment for 975374 vacuum packaging machine Kitchen Line.....	148	Bread basket GN 1/1.....	386	Charcoal Marabu.....	458
Baguette basket.....	385	Bread basket oval.....	386	Cheese grater.....	65
Bain-marie gastronorm.....	187	Bread basket - oval.....	344	Cheese-grating machine.....	226
Bain-marie pan.....	25, 120, 371	Bread basket - rectangular.....	344	Cheese knife for hard cheese.....	65
Bake- & Grill-Master.....	454	Bread basket - round.....	344, 383	Cheese knife for soft cheese.....	65
Bake-Master Maxi.....	454	Bread cutting board.....	53	Cheese slicer.....	65
Bake-Master Mini.....	454	Breadroll dispenser.....	261	Cheese slicer for soft cheese.....	65
Bakers' sieve.....	123	Bucket.....	76, 297	Cheese/sugar dish.....	354
Bakery basket.....	342	Bucket Budget Line.....	76	Chef plating set, 6 pcs, black.....	66
Bakery basket angled.....	384	Bucket miniatures.....	338	Chef plating set, 6 pcs, satined.....	66
Bakery basket angled round.....	384	Buckets with handle.....	340	Chef's hat - 10 pcs.....	302
Bakery basket GN size.....	385	Bucket with reinforced base.....	76	Chefs Torch.....	125
Bakery basket oval.....	342	Budget Line tables - screwed.....	280	Children.....	331
Bakery basket with bag.....	342	Buffet platter, oval.....	319, 323	Children's plate „Bear“.....	331
Bakery basket with stainless steel rim.....	384	Buffet table.....	404-405	Chips bag holder.....	336-337
Baking tray enamelled for Bake & Grill-master mini.....	456	Buffet table angled.....	404	Chips basket.....	336
Ball measuring pourer - 2 pcs.....	410	Buffet table round foldable.....	406	Chips colander aluminium.....	75
Banquet tray GN 1/1, with decorative rim.....	398	Built-in induction heater, 1000 W.....	159	Chips colander stainless steel.....	75
Banquet tray GN 1/1 with smooth rim.....	398	Bullet ice cube maker.....	432	Chip scoop.....	74
Barbecue apron.....	453	Butcher block HDPE.....	53	Chips serving stand for 3 bags.....	337
Barbecue skewers.....	450	Butcher's hooks - a set of 4 hooks.....	73	Chips shovel.....	74
Bar blade.....	409	Butter and fat brush flat silicone.....	121	Chocolate fountain.....	197, 379
Bar Caddy.....	412	Butter and fat brush with natural bristles - set of 2 pcs.....	121	Citrus juicer.....	421
Bar mat.....	420	Butter and fat brush with stainless steel bristles.....	121	Citrus juicer electric.....	424
Bar sieve.....	414	Butter curler.....	64	Citrus peeler.....	64
Bar sieve conical.....	414	Butter & Sauce dish - 3 pcs.....	341	Citrus Squeezers.....	421
Bar sieve conical PVD coated.....	414	C		Clearing trolley - 15x 600x400.....	262
Bar sieve PVD coated.....	414	Cake displays.....	251	Clearing trolley - 15 x GN 1/1.....	262
Bar spoon.....	414	Cake knife.....	119	Clearing trolley - 7 x GN 1/1.....	262
Bar spoon twisted.....	414	Cake mould.....	118	Clearing trolley compact storage - 15 x GN 1/1.....	263
Bartender bag.....	416	Cake scoop/cutter.....	230, 391	Cloth strainer.....	89
Base for butcher block.....	53	Cake server.....	230, 391	Cocktail shaker.....	415
Basic wire basket, oval.....	345	Cake stand cover.....	391	Cocktail shaker conical.....	415
Basket display.....	385	Cake tongs.....	382	Coffee automat cleaner, 120 tabs.....	306
Basket riser.....	384	Candle holder.....	375	Coffee cup.....	319, 321, 323, 325
Baskets.....	344, 386	Cannele Bordelais.....	124	Coffee filters Ø 25 cm - 1000 pcs.....	438
Baskets with woven sides.....	342	Can opener.....	63	Coffee machine.....	438-439
Basket with roll top cover.....	386	Can opener Kitchen Line.....	63	Coffee machine cleaner.....	306
Basting spoon.....	85	Cappuccino cup.....	319, 321, 323, 325	Coffee tamper.....	436
Beer bucket.....	433	Carafe.....	393	Coffee tamper with spring.....	436
		Carving board.....	52	Coffee/ tea pot with lid.....	350
		Carving fork.....	85, 380	Coin tokens - 100 pcs.....	433
		Cast iron casserole enamelled.....	31	Colander.....	91
		Cast iron grid.....	450	Colander Kitchen Line.....	91
		Catering chair - black.....	406	Colander Profi Line.....	91
				Colanders.....	91

Collapsible tray stand	401	Deep fryer Kitchen Line	168	Embossed vacuum bags	149, 176
Condiment holder	412	Deep fryer Profi Line, 2 x 8 l	167	Embossed vacuum bags on roll - 2 pcs	149
Condiment holder - 3 containers	412	Deep fryer Profi Line, 8 l	167	Enamelled	326
Condiment holder - 4 containers	412	Deep fryer Profi Line with drain tap, 2 x 8 l	167	Enamelled frying pan	457
Condiment holder - 5 containers	412	Deep fryer Profi Line with drain tap, 8 l	167	Enamelled paella bowls	33, 327
Condiment holder - 6 containers	412	Deep fryer Profi Line with drain tap digital - 8 l	166	Enamelled paella pan with compartments	33, 327
Condiment rack black	356	Deep fryer Profi Line with drain tap digital - 2 x 8 l	166	Enamelled pan	33, 327
Condiment rack rectangular	356	Deep fryers Profi Line	165, 167	Espresso cup	319, 321, 323, 325
Condiment rack round	356	Deep fryers Profi Line Digital	166	Extendable sink colander	91
Condiment set	331, 354-355	Deep Fryer XL Profi Line with drain tap, 10 l, 400 V	165	Extender for dishwasher basket	300
Confectionery display tray	260	Deep frying basket miniatures	336	F	
Confectionery funnel Kitchen Line	102	Deep frying basket miniatures stackable	337	Fast food trays	399
Confectionery funnel Profi Line	102	Deep frying basket miniatures stackable black	337	Fast response thermometer	96
Conical strainer	89	Deep plate	319, 326	Fat skimmer	74
Conical strainer, wire mesh	89	Degreaser foam	281, 285, 307	Fibreglass	401
Conical strainer with wire mesh	89	Delta	325	Fiesta	453
Conical strainer with wire mesh, reinforced	89	Descaler concentrate	306	Fiesta 600	453
Contact grill - double grill	173	Descaler powder	306	Fiesta 800	453
Contact grill - double version	173	Dicing disc	128	Film for Pet/CPP peel 12/40 sealers	145
Contact grill „Panini“	173	Digital blender with noise cover	142, 426	Fish bone tweezer pointed	69
Contact grill „Panini“ XL	173	Digital kitchen timer	98	Fish bone tweezer, slanted tip	69
Contact grills	172	Digital scale up to 200 kg	93	Fish bone tweezers, slanted head	69
Contact grill - single version	172	Dinner plate	319, 321, 323, 325	Fish frying pan - oval	28
Containers perforated	41	Dish warmer 2 burners	375	Fish frying pan - oval Titanium Professional	27
Container with non-stick coating	39, 222	Dish warmer 3 burners	375	Flake ice maker	432
Convection oven H90	210	Dishwasher 50x50	290	Flame tamer	451
Convection oven multifunctional	213	Dishwasher 50x50 - electronic control	288	Flat plate	326
Convection ovens & combi-ovens NANO 4x 450x340mm	216	Dishwasher basket for cutlery	300	Flip open cover	304
Convection oven with humidification H90S	211	Dishwasher basket for glasses	301	Flora	321
Convection steam ovens digital NANO GN-size	215	Dishwasher basket for glassware	300	Folding chair cover	406
Convection steam ovens manual NANO GN-size	214	Dishwasher basket for plates	300	Fondue-burner - 2 pcs	377
Convection steam oven with grill 4x GN 2/3	209	Dishwasher racks & tote box Profi Line	300	Food dehydrator Profi Line	163
Convectomat trays®	220	Dishwasher universal basket	300	Food pan GN 1/1, with 2 compartments	371
Conversion for 2 bain-marie pans	371	Dispenser bottles	100	Food ring	118
Conveyor toaster double	201, 383	Dispensers and jugs	394	Food ring and pusher square	118
Conveyor toaster single	201	Display refrigerators with lightbox	257	Food ring round	118
Cooled display with cover - Gastronorm 1/1	387	Display tray	260-261	Free-flow pourer	409
Cooling adaptor EPP GN 1/1	272	Display trays aluminium	260	Free-flow pourer - 6 pcs	409
Cooling display tray	387, 398	Display trays melamine	260	Free-flow pourer - 3 pieces	354
Cooling element	271	Display trays stainless steel	261	Free-flow pourer set - 4 pcs	410
Cordless electric kettle with temperature control	79, 186, 441	Door sign	360	Freezing element	270
Cordless kebab knife electric	175	Double adjustable wall shelf, with two steel brackets	277	French fries and nachos funnel scoop	75, 195
Corkscrew	409	Double bucket with handle	340	French fries cutter	72
Corkscrews & bottle openers	408	Double deck pizza oven 3000W	224	French fries cutting disc	128
Cotton candy machine	194	Double induction cooker Kitchen Line	155	French whisk	86
Countertop display freezer 90L	259	Double mobile trolley - 12 x GN 1/1	263	French whisk with 8 stiff wires	86
Countertop display fridge	251	Double sink table with cabinet - welded	281	Fruit basket	346
Countertop freezer display 77L	110, 250	Double sink table with shelf Budget Line - screwed	280	Fruit basket angled round black	346
Countertop salad display	250	Double sink table with shelf - for self-assembly	279	Fruit basket black	346
Cover for cotton candy machine	194	Double trolley - 30 x GN 1/1	263	Frying Basket	165
Cream jug	351	Dough cutter	119	Frying pan	28, 30, 32, 339
Cream whipper chargers	106, 419	Dough cutter serrated blade	64	Frying pans	29
Cream whipper Kitchen Line	105	Doughnut deep fryer	164	Frying pans aluminium „Marble Professional“	28
Cream whipper Profi Line	104	Dough punch roller	120	Frying pans aluminium „Platinum Professional“	29
Cream whippers	104	Dough scrapers	119	Frying pans die-cast aluminium	
Crêpe maker	194	Dough scrapers rectangular - set of 6 pcs	119	„Titanium Professional“	26-27
Crêpes pan	28, 30	Dough scrapers semi-circular - set of 6 pcs	119	Frying pans traditional	30
Crêpes pan Titanium Professional	27	Dough scrapers trapezoidal - set of 3 pcs	119	Frying pan Titanium Professional	27
Cup	326	Drainage mat	420	Frying pan, with non-stick coating - without lid	21
Cupcake mould	118	Drawer with rails - 2-piece set	239	Frying pan - without lid	21, 23
Cutlery basket	266, 301, 343	Dressing- and panwhisk	86	Frying spatula	82
Cutlery basket black	356	Dressing pot	396	Fuel dispenser	377
Cutlery basket holder	403	Drip tray for food dehydrator	163	Fuel for fondue-burners - 3 pcs	377
Cutlery box	356	Dry aging cabinet	247	Funnel	78
Cutlery tray	403	Dutch pancake griddle	451	Funnel with handle	78
Cut resistant gloves, certified	61	E		G	
Cut resistant gloves, certified - set of 2 pcs	61	Egg cup - 6 pcs	358	Galvanized buckets	340
Cutting board	52	Egg slicer - oval	70	Garlic press	63
Cutting board HACCP	50-51	Egg slicer - rectangular	70	Gas barbecue Atlanta	452
Cutting board HACCP 450x300	50	Egg spoon - 6 pcs	358	Gas barbecue „Europa“	452
Cutting board HACCP 600x400	50	Egg sterilizer, 30 eggs	302	Gas canister	125
Cutting board HACCP Gastronorm 1/1	51	Ejector disc for Vegetable Cutter	129	Gas cooker - 5 burners, open frame	152
Cutting board HACCP Gastronorm 1/2	51-52	Electric dough rollers	226	Gas cooker - 5 burners with electric oven	152
Cutting board rack	50	Electric kettle - 1,8 L	79, 186, 440	Gas cooker Kitchen Line with convection electric oven GN 1/1	151
Cutting board with grip	52	Electric kettle - 2,5 L	79, 441	Gas hose assembly Bake-, Grill- & Roast-master	456
Cutting board with handle	52, 413	Electric kettle - 4,2 L	186, 440	Gas hose assembly Green Fire Barbecues	450
D		Electric kettles	79	Gas hose assembly Hokkers	153
Decanter	438	Electric meat tenderizer	131	Gas hose assembly Patio heaters	463
Decoration knife	65	Electric milk frother	439	Gas hose assembly Xenon Pro & Fiesta barbecues	457
Decoration toolset - 6 pcs	66	Electric soup kettles	368		

Gas lighter – set of 2 pcs.....	103, 181, 375	Hokker Kitchen Line XL.....	153	J	
Gas regulator with rubber seal Bake-, Grill- & Roast-master.....	456	Hokker Profi Line.....	153	Japanese knives.....	57
Gastronorm container enamelled.....	39, 220	Hokker stand.....	152	Japanese sharpening stone HENDI by Naniwa.....	62
Gastronorm container enamelled GN 2/3.....	39	Honey dispenser.....	354	Jigger.....	415
Gastronorm container enamelled GN 2/3.....	220	Hood dishwasher 50x50.....	294	Jigger black.....	415
Gastronorm containers.....	34	Hood dishwasher - electronic controller.....	292	Jigger with ring.....	415
Gastronorm containers Budget Line.....	42	Horeca markers.....	49	Juice dispenser 2x12L.....	395, 422
Gastronorm containers Budget Line with handles.....	43	Hose with rinse head for appliances.....	217	Juice dispenser.....	394-395
Gastronorm containers Kitchen Line.....	40	Hot Chocolate Dispenser.....	442	Juice jug.....	393
Gastronorm containers polycarbonate black.....	44	Hotdog stand.....	101	Julep strainer.....	414
Gastronorm containers polycarbonate transparent.....	46	Hot drinks boiler.....	442, 446	Julienne disc.....	129
Gastronorm containers polycarbonate white.....	45	Hot drinks boiler - Design by Bronwasser.....	445		
Gastronorm containers polypropylene Profi Line.....	47	Hot drinks boiler double-walled.....	447	K	
Gastronorm containers Profi Line.....	37-38	Hot drinks boiler matt black - Design by Bronwasser.....	444	Karizma.....	319
Gastronorm grid.....	222	Hot tray.....	158, 271	Kebab grill gas Profi Line.....	174
Gastronorm pan GN 1/1.....	396			Kebab grill & knife.....	174
Gastronorm pan GN 1/2.....	396	I		Kebab knife electric.....	175
Gastronorm pan GN 1/3.....	396	Ice bucket – double walled.....	416	Kitchen bowl.....	86
Gastronorm storage containers HACCP.....	48	Ice bucket white.....	416	Kitchen Line bain-marie.....	187
Gastronorm tray GN 2/3.....	222	Ice cream bowl Clown.....	331	Kitchen Line bain-marie with drain tap.....	187
Gastronorm tray Profi Line.....	39	Ice cream cones stand.....	107	Kitchen Line cream whipper.....	105, 419
Gastronorm tray Profi Line.....	222	Ice cream container lid Polycarbonate.....	111	Kitchen Line Food dehydrator.....	162
Gastronorm tray Profi Line GN 2/1.....	39	Ice-cream cup.....	329	Kitchen Line ice cream container.....	111
Glass brush high.....	420	Ice cream dipper.....	107	Kitchen Line ice cream scoop.....	108
Glass brush round.....	420	Ice cream dipper Stöckel.....	107	Kitchen Line pizza dough box.....	229
Glass brush standard.....	420	Ice cream maker.....	110	Kitchen Line potato peeler, 10 kg.....	136
Glass cover for sausage roller grills.....	198	Ice cream scoop Stöckel.....	108	Kitchen Line potato peeler, 5 kg.....	136
Glass dome.....	103, 181	Ice cream scoop washer.....	109	Kitchen Line soup kettle, 8 l.....	368
Glass dome with vent.....	103, 181	Ice cream spatula.....	107	Kitchen scale 10 kg.....	92
Glasswasher 40x40.....	290	Ice crusher – electric.....	430	Kitchen scale 15 kg.....	93
GN 1/1 tray.....	397	Ice crusher – manual.....	430	Kitchen scale 3 kg.....	92
GN banquet tray.....	397	Ice cube ball mould.....	418	Kitchen scale 5 kg.....	92
GN containers made of porcelain.....	396	Ice cube machine.....	432	Kitchen scissors.....	61
Granite form.....	402	Ice cube machine - 12 kg.....	431	Kitchen sink – with knee-operated faucet.....	299
Grapefruit knife.....	64	Ice cube machine - Kitchen Line 15.....	431	Knife for french fries cutter.....	72
Grater, four-sided.....	70	Ice cube mould mini cube.....	418	Knife magnet with hooks.....	53
Grating disc.....	128	Ice cube moulds assorted gems.....	418	Knife sharpener.....	62
Gravy boat.....	331	Ice cube mould XL cube.....	418	Knives carrying case.....	67
Grease filter for deep fryer - 50 pcs.....	76, 297	Ice cube tongs.....	414	Knives HACCP.....	58
Grease filter holder for deep fryer.....	76, 297	Ice cube tray with lid.....	418	Knives Kitchen line.....	55
Greaseproof paper - 500 pcs.....	334	Ice shot glass mould.....	418	Knives Profi Line.....	54
Greaseproof paper lining pre-shaped - 150 pcs.....	334	Icing tips.....	116-117	Knock box GN.....	437
Greaseproof paper lining pre-shaped - 150 pcs.....	334	Icing tips - serrated.....	116-117	Knock box in wooden frame.....	437
Greaseproof paper placemat - 500 pcs.....	334	Icing tips - smooth.....	116-117	Knock box rectangular.....	437
Grease trap.....	297	Induction cooker 2000W Kitchen Line.....	154		
Green Fire with 2 burners.....	448	Induction cooker 3500W Kitchen Line.....	154	L	
Green Fire with 3 burners.....	449	Induction cooker model 1800.....	158	Ladle.....	85
Green Fire with 4 burners.....	449	Induction cooker model 2000.....	158	Ladle non-drip.....	85
Grid.....	222, 451	Induction cooker model 7000.....	157	Ladles and serving spoons buffet supreme.....	380
Griddle.....	171	Induction cooker model 3500 D.....	156	Ladles and serving spoons, heat resistant.....	381
Griddle 1/3 ribbed.....	171	Induction cooker model 5000 D.....	157	Ladles & skimmers Kitchen Line.....	85
Griddle for induction cookers.....	26	Induction cooker model 3500 D XL.....	156	Ladles & skimmers Profi Line.....	85
Griddle half ribbed.....	171	Induction cooker model 3500 M.....	156	Laundry bag for laundry trolley.....	303
Griddle ribbed.....	171	Induction cookers Kitchen Line.....	154	Laundry Trolley.....	303
Griddle scraper.....	461	Induction deep fryer with drain tap.....	169	Lava rocks - coarse.....	451
Griddles Profi Line.....	171	Induction deep fryer with drain tap, 8 l.....	169	Lava rocks - fine.....	451
Grid for Grill master.....	456-457	Induction deep fryer with drain tap - 2 x 8 l.....	169	Lemon Zester.....	64
Grid for Grill-Master Mini.....	456	Induction frying pan.....	26	Lid clips for HACCP storage containers.....	49
Grid for ovens H90 and H90S.....	211	Induction heater 800W.....	159	Lid for GN containers.....	39, 41, 43-44, 46
Grid for Roast Master 50/50.....	457	Induction hokker high power.....	150	Lid for GN containers black polycarbonate.....	44
Grill barbecue Green Fire.....	448	Induction hot plate Kitchen Line.....	155, 375	Lid for GN containers made of polypropylene, with seal.....	47
Grill-Master Maxi.....	454	Induction stove with 4 hobs.....	150	Lid for GN containers polypropylene.....	47, 49
Grill-Master Mini.....	454	Induction wok model 3500.....	156	Lid for GN containers purple.....	49
Grill-Master Quattro.....	455	Infrared heat bulb.....	170	Lid for GN containers white polycarbonate.....	45
Grill pan - ridged surface Titanium Professional.....	27	Infrared thermometer.....	96	Lid for GN containers with silicone rim.....	39, 43
Group head cleaning brush.....	436	Infrared thermometer with probe HACCP.....	96	Lid for GN containers with soup/sauce ladle recess.....	41
		Ingredient boxes.....	412	Lid for GN containers with sous vide stick.....	
H		Ingredient trolley.....	267	recess.....	39, 46, 177-178
HACCP Cutting mat set - 6 pieces.....	52	Insect killer 300 m ²	310	Lid for GN containers with spoon recess.....	39, 45
Hamburger press.....	133	Insect killers for indoor use.....	310	Lid for racks.....	301
Hamburger turner.....	83	Insect killers for outdoor use.....	311	Lids for stew pans.....	23
Hand dryer.....	302	Insect killers for use in the kitchen & restaurant.....	310	Lid spacer for pizza's - 500 pcs.....	234
Heated countertop cabinet.....	161	Insect killer water resistant.....	311	Lid with dispenser for GN containers.....	99
Heated countertop display.....	160-161	Insect killer with adhesive plate 100 m ²	310	Lift Salamander 450.....	191
Heating element.....	270	Insect killer with adhesive plate 120 m ²	311	Lift Salamander 600.....	191
Heavy-duty storage rack.....	275	Insulated beverage dispenser with tap.....	268	Lionhead.....	328
HENDI Blend stick blender.....	138	Insulated catering container GN 1/1, top-loaded.....	268	Liquid fuel with wick.....	378
HENDI Jet chefs' torch.....	126	Insulated ice container - 110 L.....	267	Loading table with sink for dishwasher.....	286
HENDI Samurai Japanese mandoline.....	71	Insulated portable container.....	273	Lobster and crab cracker.....	316
High power blender.....	143, 427	iVide circulator stick for Sous-Vide 2.0 cooking.....	177	Lobster forks - 6 pcs.....	316
High voltage insect killer.....	310	iVide Plus Junior.....	179	Lounge Heater.....	463
Hokker Kitchen Line.....	153	iVide Plus Sous vide thermal circulator.....	178	Low temperature oven.....	208

LPG gas cartridge	127
M	
Madeleines	124
Measuring jug	77
Measuring jug polypropylene	77
Measuring jug stackable	77
Meat Mincer 198	131
Meat mincer Kitchen Line 12	130
Meat mincer Kitchen Line 22	130
Meat mincer knife	130
Meat tenderizer Profi Line	73
Meat Tenderizers	73
Meat tenderizing hammer	73
Meat tray	260-261
Melamine	397
Melon scoop double	64
Melon scoop oval	64
Melon scoop serrated	64
Menu and cutlery box	356
Menu card holder - 2 pcs	359
Menu card table stand	359
Menu clipboard	360
Milk dispenser - 10,5 l	395
Milk frothing thermometer	98, 437
Milk jug	350
Milk jug black	351, 437
Milk jug - matt black	351, 437
Milkshake mixer BPA Free - Design by Bronwasser	113, 429
Milkshake mixer - Design by Bronwasser	112, 428
Mincing knife	65
Mini-cake	124
Mini griddle pan Little Chef	333
Mini oval pan Little Chef	333
Mini round pan Little Chef	333
Mini sauce dispenser - set of 4 pcs	100
Mini saucepan Little Chef	333
Mixing bowl	87
Mobile trolley for dishwasher baskets - 7 x 500x500 mm	301
Mounting bracket for scoop washer	109
Mounting frame for induction heater, 800W	159
Movable tables with shelf	286
Muddler	413
Muesli dispenser	393
Muesli/salad bowl	321
Muffins	124
Mug	323, 326
Mug copper plated	414
Multipurpose jugs	350, 437
Multipurpose tweezer coated	69
Multipurpose tweezers	68
Multitrack	393
Multi Toaster 6 tongs	200
Mussel & gravy pans	32
Mussel pan - with lid	32

N	
Nacho warmer	195
Napkin holder	358
Napkin holder black	358
Napkin holder with 3 compartments	412
Non-drip bracket wall mounted	410
Non-drip pourer	410
Non-drip sauces dispenser	101
Non-slip display stands	392
Non-slip display stands round	392
Non-stick coated blade	135
Non-stick mat for rice cookers	188
Non-stick silicone baking mat	121
Nut and seafood cracker matt black	316

O	
Offset tweezers	68
Oil and vinegar set	354
Olive oil dispenser	78
Olive wood holder	317
Onion goggles	53
Oval dish	321, 325
Oven dishes cream porcelain	331
Oven dishes white porcelain	330
Oven dish round	331
Oven glove heat resistant - 2 pcs	219, 440

Oven grid chrome plated	217
Oven grid GN 1/1	222
Oven mitts	218
Oven mitts, cotton - 2 pcs	219, 460
Oven mitts, fiberglass - 2 pcs	219, 460
Oven mitts, flame retardant cotton - 2 pcs	219, 460
Oven thermometer	97
Oven tray 450x340 mm	217
Oven tray for Convection oven multifunctional	213
Oyster knife long	61
Oyster knife round	61
Oyster knife straight	61

P	
Paella pan	29, 453
Palette knife	83, 120
Palm tamper adjustable	436
Pan gripper	235
Pan series Budget Line	24
Pan series copper	32, 339
Pan series Kitchen Line	22
Pan series Profi Line	20
Pan support adapter	25, 151
Paper bread bags	346
Paring knife	60, 413
Paring knife with wooden handle	60
Paring knives	60
Paring knives and peelers	60, 413
Paring knives, set of 6 colours	60
Party pan	185
Party tub	340, 417
Pass-through cupboards with sliding doors	287
Pass-through cupboard with partition and sliding doors	287
Pass-through cupboard with sliding doors	287
Pasta cooker basket	21
Pasta maker	228
Pasta maker electric	228
Pasta plate	325
Pastry bag anti slip - 100 pcs	114
Pastry bags	114-115
Pastry bags - set of 2 pcs	115
Pastry cutters, round - set	119
Pastry tong	382
Patio Heater	462
Patio heater Pyramid	463
Patio Heater - retractable	462
Patty dividers	133
Pavement blackboard	362
Peeler	60
Pepper shaker	355
Percolator	446
Percolator and hot drinks boiler - Design by Bronwasser	445
Percolator and hot drinks boiler matt black - Design by Bronwasser	444
Percolator - Design by Bronwasser	445
Percolator double walled	447
Percolator matt black - Design by Bronwasser	444
Percolators and hot drinks boilers	446
Percolators and hot drinks boilers double walled	447
Perfect for preparing freddo cappuccino, frappé and milkshakes	112, 428
Perforated drip shelf for GN containers	41
Perforated drip shelf for GN containers polycarbonate	46
Perforated pizza pan	235
Perforated plate	130
Piano whisk	86-87
Piano whisk with 12 piano wires	87
Pitcher	393
Pitcher with ice tube	393
Pitta bread basket - oval	344
Pitta bread basket - round	344
Pizza board	235
Pizza board with handle	234
Pizza counters	244-245
Pizza delivery bag 35 cm	236
Pizza delivery bag 35 cm Kitchen Line	236
Pizza delivery bag 45 cm Kitchen Line	236
Pizza dough box	229
Pizza & food delivery backpack insulated	237
Pizza oven	223
Pizza oven Basic	225

Pizza oven cleaning brush	231
Pizza oven compact	224
Pizza ovens compact	224
Pizza pan	234
Pizza plate Speciale	233
Pizza plate Speciale Barocco	233
Pizza plate Speciale decorated	233
Pizza plate Speciale granite	233
Pizza plate Speciale gray	233
Pizza plate Speciale orange	233
Pizza plate Speciale yellow	233
Pizza plates Speciale	233
Pizza scoop	230
Pizza scoop round	230
Pizza scoop, round, perforated	230
Pizza scoop squared	230-231
Pizza scoop, squared	231
Pizza scoop squared with short handle	232
Pizza scoop with short handle, squared, perforated	232
Pizza scoop, wooden	231
Pizza screen	234
Pizza screen/pan rack	235
Pizza slicer	65, 232
Pizza thermobox Profi Line	272
Placemat - set	335
Planetary Mixers Kitchen Line	137
Plastic driptray for food dehydrators	162
Plate Bark	328
Plate trolley	266
Platform trolley	265
Platter, rectangular	397
Pocket thermometer	97
Pocket thermometer with probe	97
Polycarbonate ice cream container	111
Polycarbonate mixing cup for milkshakers - Design by Bronwasser	113, 429
Polyester tray, for self-service restaurants	402
Polyester tray, non-slip, oval	401
Polyester tray, non-slip, rectangular	401
Polyester tray, non-slip, round	401
Polyester tray, oval, XL	401
Polyethylene butcher block with base	53
Polypropylene cutlery basket	403
Polypropylene Euronorm	400
Polypropylene fast food tray, large	399
Polypropylene fast food tray, medium	399
Polypropylene fast food tray, oval	400
Polypropylene fast food tray, small	399
Polypropylene scoop	77
Popcorn machine	197
Potato masher	88
Potato peeler	65
Potato peelers Kitchen Line	136
Potato ricer	88
Pot stand	286
Poultry shears	61
Pourers	409
Presentation cover GN 1/1	390
Presentation displays and covers	387
Presentation miniatures	333, 336
Pressure food sprayer	78
Pressure regulator 37 mBar	456, 463
Pressure regulator 50 mBar	153
Pressure regulator 50 mBar for gas barbecue propane/butane	456
Professional grill and oven cleaner	307
Profi Line decorating and injector tips	104
Profi Line Food dehydrator	163
Profi Line ice cream container	111
Profi Line ice cream scoop	108
Profi Line lid for bucket with reinforced base	76
Profi Line rice cooker & warmer 5.4 l	188
Profi Line sausage filling machine	132
Profi Line slicer	134
Profi Line strip vacuum packaging machine	148
Protective cover	455
Pull-out basin tap	298

Q	
Quartz heated countertop display	160
Quartz salamander MAXI GN 1/1	190

R			
Rack for 18 vegetable cutter discs	129	Salamander with quartz infrared heating elements GN 1/1	191
Ramekin	125, 328, 341	Salt and pepper shaker	75
Rasping disc	129	Salt and pepper shaker set	355
Rasps	70	Salt grinders & pepper mills	352
Rear shelf for Green Fire grills	450	Salt shaker	355
Receipt holder	359	Salt tablets for water softening	308
Receipt holder - 3 pcs	359	Sandwich toaster	200
Reception bell	358	Saturn	323
Refrigerated countertop server	246	Sauce bain-marie with dispenser	99, 195
Refrigerated countertop server GN 1/3 Arctic	246	Sauce boat	329
Refrigerated countertop server GN 1/4 Arctic	246	Sauce dispenser with pump	100
Refrigerated display cabinet, 270 l	253	Sauce ladle	381
Refrigerated display cabinet, 58 l	252	Saucepan - without lid	21, 23, 32, 339
Refrigerated display cabinet, 68 l	252	Saucer for cappuccino cup	319, 321, 323, 325
Refrigerated display cabinet, 78 l	253	Saucer for coffee cup	319, 321, 323, 325
Refrigerated display cabinet, 98 l	253	Saucer for espresso cup	319, 321, 323, 325
Refrigerated display cabinets	252	Saucer for soup bowl	319, 321, 323, 325
Refrigerated display cabinets, Arctic	254	Sauce stand	101
Refrigerated display cabinets with 2 shelves	255	Sausage cutter	199
Refrigerated display cabinets with 3 slanted shelves Arctic	255	Sausage cutter - electric	199
Refrigerated display cabinets with back access	254	Sausage cutter - manual	199
Refrigerator & freezer counters Profi Line 700 series	239	Sausage rolling grill - one zone	198
Refrigerator thermometer	98	Sausage rolling grills	198
Replacement knife for electric meat slicers	135	Sausage rolling grill - two zones	198
Replacement knife for kebab knives	175	Sausage warmer	199
Replacement lamp for fly killers	311	Sauté pan Titanium Professional	27
Restaurant calling system	407	Sauté pan - without lid	21, 23
Restaurant pagers - set of 10 pcs	407	Saves up to 20% of energy	447
Rice cooker 10 L	189	Scales	92
Rice cooker 4.2 L	189	Scraper	83-84, 122
Rice cooker with steamer function	188	Scraper spoon shaped	84, 122
Ring for Hokker	152	Sea food tray stand	392
Rise and fall heat lamp conical	170	Semi-sphere	124
Rise and fall heat lamp cylindrical	170	Serving basket	345
Roasting pan	25	Serving basket black	345
Roasting thermometer with timer	97	Serving baskets fast food style	343
Roast-Master Maxi	455	Serving board, olive wood, rectangular	317
Roast-Master Maxi 50 50	455	Serving board, olive wood, rectangular, with groove	317
Rollers for beef and pork	131	Serving board, olive wood, rectangular, with handle	317
Rollers for poultry	131	Serving board, olive wood, rectangular, with opening	317
Rollers for shoarma	131	Serving dish	329, 399
Rolling pin with non-stick coating	123	Serving spoon	85, 380
Rolltop-Chafing dish Gastronorm 1/1	374	Serving stand for plates	392
Rolltop-Chafing dish - round	374	Serving stands	392
Roll Top Cool Display Tray Double Deck	389	Serving tong HACCP 250 mm	81
Roll-top cooling display double	388	Serving tongs	80-81, 382
Roll-top cooling display single	388	Serving tongs - 2 pcs	80
Roll Top Display, double-purpose, Single Deck	388	Serving tongs curved	80
Roll top display - single	389	Serving tongs HACCP 300 mm	81
Roll top for bread basket round	383	Serving tray GN 1/1	398
Rolltop presentation cover	390	Serving tray GN 1/1, with slanted rim	398
Rolltop presentation cover GN 2/3	390	Serving tray, oval	399
Rotating cake stand	391	Serving tray, oval, non-slip, laminated	402
Roulade string	73	Serving tray, rectangular, non-slip, black	400
Roulade string red & white	73	Serving tray, rectangular, non-slip, laminated	402
Round bar table	405	Serving tray, round	398
Round cake display, Arctic	254	Serving tray, round, non-slip	400
Round container body	304	Serving tray, round, non-slip, high rim, laminated	402
Round display roll-top cover	389	Serving tray, round, non-slip, laminated	402
Round knock box	437	Serving trays, non-slip	402
Round lid	304	Serving tray with melamine laminate, non slip, with wood design	400
Round open cover	304	Serving trolley	264
Round tray with cover	389	Serving trolley heavy duty	264
Round trolley	304	Serving trolley matt black	264
Rustica oven dish oval	330	Serving trolley with 4 shelves	265
Rustica oven dish rectangular	330	Serving trolley with 5 shelves	265
Rustica oven dish round	330	Set: 2 x Stainless steel sauce container with dispenser	99
Rustica oven dish square	330	Set of 4 feet for refrigerators and freezers	238
		Shaker	354
		Shelf for Blast chillers	249
S		Shelf for counter refrigerator & freezers 2-doors Kitchen Line	245
Safe can opener	63	Shock proof thermometer with probe	96
Salad bowl	319, 323, 325-326	Side table for Green Fire barbecues	450
Salad counters	242	Sieve	90
Salad fork	381	Sieve, double mesh	90
Salad spinner	78	Silicone moulds	124
Salad spoon	381	Silicone tong for cooking	82
Salad tongs	80, 382	Single basin table - welded	283
Salamander	190	Single Pedestal Pre-Rinser	298
Salamander GN 1/1 wall mountable	190		
Salamander wall mountable	190	Single sink table Budget Line - screwed	282
		Single sink table with cabinet - welded	281
		Single sink table with shelf - for self-assembly	279
		Sink	279
		Sink tables - screwed	279
		Sink table - welded, 2 sinks	284
		Sink table with cabinet - welded	281
		Sink tap	298
		Sink tap with long lever	298
		Skimmer	85, 380
		Skimmer, round	380
		Slicer Profi Line 195	134
		Slicer Profi Line 220	134
		Slicer Profi Line 250	134
		Slicer Profi Line 300	134
		Slicer Profi Line 220 Red Edition	135
		Slicer Profi Line 250 Red Edition	135
		Slicing disc	128
		Slim Rectangle Container 60L	305
		Slotted spatula	85, 380
		Slotted spoon	85, 380
		Slow pourer with flip top - 6 pieces	409
		Slush machine	423
		Slush machine 2x12L	423
		Small frying pan	338
		Small sauce pan with spout	338
		Smoke Infuser	103, 181
		Smoke oven electric	223
		Smoking chips	223
		Smoking dust assortment - set of 9 flavors	183
		Smoking gun rechargeable - 3 speeds of smoke infusion	103
		Smoking gun rechargeable - 3 speeds of smoke infusion	180
		Snack basket	343
		Snack can	338
		Snack pan	339
		Snail fork - 6 pcs	316
		Snail tongs - 2 pcs	316
		Soda chargers - 10 pcs	419
		Soda siphon	419
		Soft serve and whipped cream machine cleaner	307
		Solid design - thickness 1 mm	80
		Soup and sauce bowls	329
		Soup bowl	319, 321, 323, 325, 328-329
		Soup chafing dish	370
		Soup chafing dish mirror finish	373
		Soup & gravy pan - with lid	32, 327
		Soup kettle	368
		Soup ladle	380-381
		Soup pan for electric soup kettle	368
		Soup plate	321, 323, 325
		Soup tureen	329
		Sous-vide cooking bags for vacuum packing machines	149
		Sous-vide system	176
		Sous-vide system GN 1/1	176
		Sous-vide system GN 2/3	176
		Spaghetti tongs	382
		Spare parts set	104-105
		Spatula	82-83, 85, 120
		Speed peeler	60
		Spice mat for Food Dehydrator	163
		Spiraalgarde	86
		Spiral mixers	227
		Spiral mixer with fixed head and bowl	227
		Spiral mixer with rising head and removable bowl	227
		Spoon	84, 122
		Spoon holder	380
		Spreader - serrated	64
		Spring for coffee filter holder	439
		Square bowl	397
		Stainless steel cleaner	282, 307
		Stainless steel cutlery basket	403
		Stainless steel mixing cup for milkshakers - Design by Bronwasser	113, 429
		Stainless steel rolling pin	123
		Stainless steel sauce container with dispenser	99
		Stand for convection steam oven with grill 4x GN 2/3	209
		Stand for ovens H90 & H90S	211
		Standing Ashtray Pole	365
		Standing waste bin with ashtray	305, 365
		Steak cutlery	316

Steak fork - 6 pcs.....	316	Tapasmini.....	332	Vegetable cutter Profi Line.....	128
Steak knife - 6 pcs.....	316	Tap with pull out rinser.....	299	Vegetable cutter V-type.....	71
Steak knife XL - 6 pcs.....	316	Tartlette.....	124	Vegetable cutter V-type double bladed.....	71
Steak thermometer - set of 4 pcs.....	97	Tea box.....	357	Vegetable dish.....	329
Steam convection oven.....	212	Tea & herb strainer.....	357	Vegetable spoon.....	85
Step-on container.....	305	Tea strainer - with hinged handle.....	357	Vegetable strainer.....	89
Stew pan high - with lid.....	20, 22	Teflon tape for top sealbar.....	147	Velocity slanted bowls.....	341
Stew pan high - without lid.....	23	Tepan-yaki griddle.....	185	Very hard poly-ethylene.....	50-51
Stew pan low - with lid.....	20, 22	Thermobox Profi Line.....	272	W	
Stew pan low - without lid.....	23	Thermo catering box.....	270-271	Waffle maker „Brussels“.....	193
Stew pan (medium) - with lid.....	22	Thermo catering container 2x GN 1/1 200.....	269	Waffle maker corn dog.....	192
Stew pan middle - with lid.....	20	Thermo front loaders.....	270	Waffle maker „Heart“.....	193
Stew pan middle - without lid.....	23	Thermometer with foldable probe.....	96	Waffle maker „Liege“.....	193
Stew pan with lid.....	24	Thermostat cable for party pan.....	185	Waffle maker lollypop.....	192
Stick blender 250VV - with adjustable speed.....	141	Thermo system.....	187	Waffle maker round.....	192
Stick blender drive unit - variable speed 350 W.....	139	Thermosystem 1.....	187	Waffle makers.....	193
Stick blender drive unit - variable speed 500 W.....	139	Thermosystem 2.....	187	Waiter's corkscrew.....	408
Stick blender Kitchen Line.....	139	Three door pizza counter with cooling display 380+40L.....	245	Waiter's friend corkscrew.....	408
Stick blender Kitchen Line 160 with adjustable speed.....	139	Tiered stand.....	392	Wall blackboard.....	362
Stick blender Profi Line 400 - adjustable speed set with storage rack.....	141	Tin Tin cocktail shaker.....	415	Wall Mounted Ashtray.....	365
Stick blenders Profi Line.....	140	Toaster tong.....	200	Wall mounted bottle opener.....	408
Stick blender variable speed with whisk and wall-mounted rack.....	141	Tomato knife.....	60, 413	Wall mounted cabinet with sliding doors - welded.....	283
Stirrers BPA-free for milkshake mixers - Design by Bronwasser.....	113, 429	Tomato knife offset.....	65	Wall-mounted extractor hood.....	287
Stirrers for milkshake mixers - Design by Bronwasser.....	113, 429	Tomato slicer.....	72	Wall mounted storage rack.....	140
Stöckel ice cream dipper.....	107	Tong for Sandwich toaster.....	200	Wall rack for pastry bags.....	115
Stöckel ice cream scoop.....	109	Top grid for charcoal barbecues.....	458	Wall shelf, with two steel brackets.....	277
Stöckel oval ice cream scoop.....	109	Top grid for Roast-master.....	457	Wall work table cabinets - welded.....	281
Stopper - 6 pcs.....	411	Top grid for Xantos barbecue.....	464	Wall work table cabinet with sliding doors - welded.....	281
Stopper with cap - 6 pcs.....	411	Tortilla press.....	133	Wall work table with shelf Budget Line - screwed.....	280
Storage racks with 4 shelves.....	277	Tote box.....	266	Wall work table with upstand and shelf.....	278
Storage rack with 5 shelves.....	275	Trash bag holder.....	303	Washbasin knee operated.....	299
Store & pour bottle.....	411	Trash bin 43 L.....	303	Water kettle with lid.....	79, 440
Strainer.....	414	Tray.....	221	Waterproof thermometer.....	97
Sugar bowl.....	357	Tray for french bread.....	222	Water softener.....	309
Sugar cube tongs - 2 pcs.....	357	Tray for ovens H90 and H90S.....	211	Water softener, automatic.....	308
Sugar dispenser.....	354	Tray GN 1/1 - with 4 rims.....	221	Water softener, semi-automatic.....	308
Sugar/whipped cream dish.....	357	Tray perforated.....	221	Water softeners Manual.....	309
Sushi display 5x GN 1/3.....	251	Tray perforated GN 1/1 - with 4 rims.....	221	Wet floor sign.....	303
T		Tray perforated GN 2/3 - with 4 rims.....	221	Whisk attachment for stick blender 222140.....	139
Tab grabber.....	53	Tray sealer Compact.....	145	Whisk attachment for stick blender motor 221884 & 221891.....	139
Table beer tap.....	433	Tray sealer HENDI matrix.....	145	Whisk attachment for stick blender Profi Line 300, 400 & 500.....	140
Table caddy.....	340, 356	Tripod for Infrared patio heater.....	464	Whisks.....	86
Table caddy black.....	356	Trolley for dishwasher racks.....	301	Wine cooler.....	417
Tablecloth clip - 4 pcs.....	358	Trolley for dishwasher racks with handle.....	301	Wine cooler EPP.....	417
Table cover Symposium, rectangular.....	405	Trolley for tables.....	404	Wine coolers, dual zone.....	259, 435
Table cover Symposium, round.....	405	Trolley for thermo container.....	269	Wine cooler stand.....	416
Table cover Symposium, round ø70-85 cm.....	405	Truffle slicer.....	57	Wine cooler table bracket.....	417
Table sign „No smoking“.....	360	Tumbler.....	326	Wire basket basic round.....	345
Table sign Reserved.....	361	Turner flexible.....	83	Wire basket deco oblong.....	345
Table signs numbered.....	361	Turner flexible, perforated.....	83	Wire basket deco oval.....	345
Tablestand numbers.....	361	Tweezer, curved, with profiled handle.....	68	Wire basket deco rectangular.....	345
Tabletop blackboard - 2 pcs.....	363	Tweezer, cylindrical head.....	69	Wire basket deco round.....	345
Tabletop litterbin.....	359	Tweezer, round head.....	68	Wire baskets.....	345
Tabletop litterbin or cutlery holder.....	359	Tweezers curved.....	68	Wire brush.....	461
Table with 1 sink bowl and a shelf - screwed, depth: 600 mm.....	284	Tweezer, square head.....	68	Wire brush set narrow - 3 pcs.....	461
Table with sink, dishwasher space and shelf.....	285	Tweezers, round head, coated.....	69	Wire brush Y-shaped.....	461
Taco holder.....	101, 261	U		Wok.....	28, 152, 157
Tampa gas grill.....	452	UNIQ Chafing dish.....	366	Wok 3-ply - without lid.....	33
Tamping mat.....	436	UNIQ Soup kettle.....	367	Wok Titanium Professional.....	27
Tamping mat double.....	436	Universal tongs.....	81-82, 382	Wooden pepper mill.....	353
Tamping stand.....	436	Universal tongs with teflon coating.....	82	Wooden rolling pin.....	123
Tapas dish Cacerole - 6 pcs.....	332	Unloading table for dishwashers.....	286	Wooden salt grinder.....	353
Tapas dish Concha - 6 pcs.....	332	UV sterilizer.....	67, 302	Wooden spatula - set of 4.....	82
Tapas dish Cuadrado - 6 pcs.....	332	V		Wooden spoon - set of 3, various sizes.....	84, 122
Tapas dish Cuchara - 6 pcs.....	332	Vacuum chamber packaging machine Kitchen Line.....	146	Wooden spreader for crêpe makers.....	194
Tapas dish Huevo - 6 pcs.....	332	Vacuum chamber packaging machine Profi Line.....	146-147	Works also with a GN tray up to GN 1/2.....	155, 375
Tapas dish Leon - 6 pcs.....	332	Vacuum jug.....	347, 349	Work table heavy duty.....	278
Tapas dish oval.....	330	Vacuum jug with glass inner bottle.....	348	Work tables self-assembly.....	278
Tapas dish Plato - 6 pcs.....	332	Vacuum packaging machine Kitchen Line.....	148	Worm shaft.....	130
Tapas dish rectangular.....	330	Vacuum packing bags.....	149	X	
Tapas dish Redondo - 6 pcs.....	332	Vacuum packing bags, for chamber vacuum packing machines.....	149	Xenon Pro.....	457
Tapas dish Triangolo - 6 pcs.....	332	Vegetable corer.....	64		
		Vegetable cutter.....	71		
		Vegetable cutter heavy duty.....	129		



PAN SERIES PROFI LINE

- Thick sandwich bottom (stainless steel/aluminium/stainless steel) combines the heat spreading properties of aluminium with the durability and magnetic properties of stainless steel, making it suitable for use on induction stoves.
- The bottom is formed by high impact bonding, causing the whole surface of the layers to weld seamlessly.
- Solid handles, thanks to the clever way of mounting the heat from the pans isn't transferred into the handles.
- The pans are acid resistant and easy to clean.



STEW PAN HIGH - WITH LID

code	liters	wall (mm)	mm
832004	3	0.7	ø160x(H)150
832202	6	0.7	ø200x(H)190
832400	10	0.7	ø240x(H)220
832509	16	0.7	ø280x(H)260
832608	24	0.8	ø320x(H)300
832707	37	1	ø360x(H)360
832806	50	1	ø400x(H)400
832929	70	1	ø450x(H)450
833025	95	1	ø500x(H)500

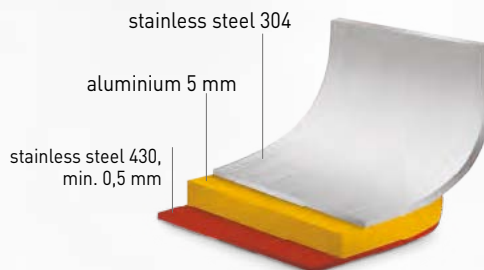

STEW PAN MIDDLE - WITH LID

code	liters	wall (mm)	mm
831007	2	0.7	ø160x(H)110
831205	4	0.7	ø200x(H)130
831403	7	0.7	ø240x(H)150
831502	10	0.7	ø280x(H)170
831601	15	0.8	ø320x(H)190
831700	23.5	1	ø360x(H)230

STEW PAN LOW - WITH LID

code	liters	wall (mm)	mm
830000	1.5	0.7	ø160x(H)75
830208	2.8	0.7	ø200x(H)90
830406	4.8	0.7	ø240x(H)105
830505	7.5	0.7	ø280x(H)120
830604	12	0.8	ø320x(H)150



833506

With extra hook to support while draining



Watch the video



PASTA COOKER BASKET

- Suitable for stew pan Ø 360 mm - 831700.
- With extra hook to support while draining.

code	liters	mm
833506	1.5	160x160x(H)230

SAUCEPAN - WITHOUT LID

- Long, stay-cool handle made from stainless steel.

code	liters	wall (mm)	mm
830055	1.5	0.7	ø160x(H)75
830048	1	0.7	ø140x(H)70
830154	2	0.7	ø180x(H)80
830253	3	0.7	ø200x(H)90



830048
830055
830154
830253

SAUTÉ PAN - WITHOUT LID

- Long, stay-cool handle made from stainless steel.
- Ideal for pouring thanks to the sharply formed edge.

code	liters	wall (mm)	mm
830352	0.9	0.7	ø160x(H)60
830376	1.5	0.7	ø200x(H)60



830352
830376

FRYING PAN - WITHOUT LID

- Long, stay-cool handle made from stainless steel.

code	wall (mm)	mm
835432	0.7	ø240x(H)45
835531	0.7	ø280x(H)50
835630	0.7	ø320x(H)55



835432
835531
835630

FRYING PAN, WITH NON-STICK COATING - WITHOUT LID

- Teflon® Platinum Plus non-stick coating.
- Long, stay-cool handle made from stainless steel.
- Handle attached with rivets.

code	wall (mm)	mm
835500	0.7	ø280x(H)50
835401	0.7	ø240x(H)45
835609	0.7	ø320x(H)55



835401
835500
835609





PAN SERIES KITCHEN LINE

- Encapsulated sandwich type bottom.
- Combines the heat distribution of aluminium with the durability and magnetic properties of steel to allow induction cooking.
- Satin finish of all outer surfaces.
- Steel handles affixed with multi-point welding stay cool enough to touch.



Watch the video



STEW PAN HIGH - WITH LID

code	liters	wall (mm)	mm
837108	2.8	0.6	ø160x(H)140
837207	5	0.6	ø200x(H)160
837306	9	0.7	ø240x(H)200
837405	13.5	0.7	ø280x(H)220
837603	21	0.8	ø320x(H)270



STEW PAN (MEDIUM) - WITH LID

code	liters	wall (mm)	mm
836101	1.9	0.6	ø160x(H)95
836200	3.5	0.6	ø200x(H)115
836309	6	0.6	ø240x(H)135
836408	9.5	0.7	ø280x(H)155
836507	15	0.8	ø320x(H)190



STEW PAN LOW - WITH LID

code	liters	wall (mm)	mm
836002	1.5	0.6	ø160x(H)75
836019	2.9	0.6	ø200x(H)95
836026	4.9	0.6	ø240x(H)110
836033	7.3	0.7	ø280x(H)120
836040	12	0.8	ø320x(H)150

LIDS FOR STEW PANS

code	mm
837818	ø160
837825	ø200
837832	ø240
837849	ø280
837856	ø320



STEW PAN HIGH - WITHOUT LID

code	liters	mm
837757	2.8	ø160x(H)140
837764	5	ø200x(H)160
837771	9	ø240x(H)200
837788	13.5	ø280x(H)220
837795	21	ø320x(H)270

837818

837832

STEW PAN MIDDLE - WITHOUT LID

code	liters	mm
837696	1.9	ø160x(H)95
837719	3.5	ø200x(H)115
837726	6	ø240x(H)135
837733	9.5	ø280x(H)155
837740	15	ø320x(H)190

837689



837641

837665

STEW PAN LOW - WITHOUT LID

code	liters	mm
837641	1.5	ø160x(H)75
837658	2.9	ø200x(H)95
837665	4.9	ø240x(H)110
837672	7.3	ø280x(H)120
837689	12	ø320x(H)150

SAUCEPAN - WITHOUT LID

- Long, stay-cool handle made from stainless steel.

code	liters	wall (mm)	mm
838105	1.5	0.6	ø160x(H)75
838204	2.9	0.6	ø200x(H)95
838303	4.9	0.6	ø240x(H)110

838105
838204
838303



SAUTÉ PAN - WITHOUT LID

- Long, stay-cool handle made from stainless steel.

code	liters	wall (mm)	mm
839300	1	0.6	ø160x(H)60
839409	1.7	0.6	ø200x(H)65

839409



FRYING PAN - WITHOUT LID

- Long, stay-cool handle made from stainless steel.

code	wall (mm)	mm
838501	0.6	ø240x(H)50
838600	0.6	ø280x(H)50
838617	0.7	ø320x(H)50

838501
838600
838617





PAN SERIES BUDGET LINE

- Sandwich type bottom (stainless steel / aluminium / 18/0 stainless steel) combines the heat distribution of aluminium with the durability and magnetic properties of stainless steel to allow induction cooking.
- Satin finish of all outer surfaces.
- Riveted stainless steel handles which don't get hot.



STEW PAN WITH LID

code	liters	wall (mm)	mm
834206	25	0.8	ø345x(H)350
834404	36	1	ø360x(H)360
834701	50	1	ø400x(H)400
834909	71	1	ø450x(H)450
835104	98	1	ø500x(H)500

Sandwich type bottom



Riveted handle



Handles don't get hot





833032

BAIN-MARIE PAN

- Double walled, with reservoir for water.
- Fill the reservoir with water to melt chocolate au bain-marie.
- With stainless steel handle.

code	liters	mm
833032	1	330x165x(H)95



833100



ASPARAGUS AND PASTA PAN XL

- Extra height allows the steaming of extra long asparagus.
- Can also be used for steaming other vegetables, steaming fish, cooking pasta, keeping hot dogs warm, etc.
- Set consists of pan, steamer basket and lid.

code	liters	mm
833100	5.5	ø162x(H)280



508527

ROASTING PAN

- With handles.
- Only suitable for ovens, not for direct contact heating.

code	mm
508503	310x240x(H)50
508510	385x275x(H)60
508527	430x310x(H)60

PAN SUPPORT ADAPTER

- For placing small pans on large pan supports.

code	mm
839997	255x255x(H)25

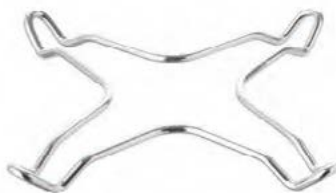

839997





FRYING PANS DIE-CAST ALUMINIUM ,TITANIUM PROFESSIONAL'

- Made of cast aluminium, suitable for all heat sources and even suitable for use in ovens (up to 250°C).
- Cast aluminium excels at conducting heat, the pan is quickly ready for use.
- The handle is made from 18/10 stainless steel and remains cool during use.
- The 'Teflon™ Platinum Plus' non-stick coating has a high temperature resistance (up to 250°C).
- The coating is applied in three layers which increases the wear resistance and makes the pan ideal for intensive use.
- Very easy to clean after use.



INDUCTION FRYING PAN

code	bottom (mm)	mm
629154	ø190	ø250x(H)50
629253	ø220	ø290x(H)55
629345	ø260	ø330x(H)60

629154
629253
629345



Primer coating: for anti-corrosion, anti-shock & better durability of coatings

Titanium coating: for anti-scratch & anti-abrasion

Mid coating: Whitford® Xylan non-stick

Top coating: Reinforcement of non stick layer and brighten surface

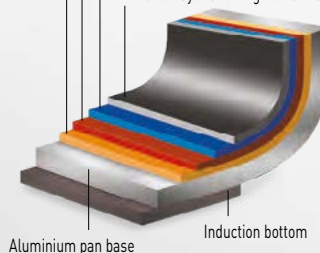

Induction bottom



With strong stainless steel handle



GRIDDLE FOR INDUCTION COOKERS

- Suitable for use on induction stoves.
- Made of die cast aluminium with Teflon® non-stick coating.
- Suitable for heat-sources up to 250 °C.

code	mm
629130	390x260x(H)35

FRYING PANS DIE-CAST ALUMINIUM ,TITANIUM PROFESSIONAL'

- Made of cast aluminium, suitable for all heat sources except induction and even suitable for use in ovens (up to 250°C).
- Cast aluminium excels at conducting heat, the pan is quickly ready for use.
- The handle is made from 18/10 stainless steel and remains cool during use.
- The Whitford® Xylan non-stick coating has a high temperature resistance (up to 250°C).
- Adhesion of the non-stick coating is improved by a layer of titanium between the aluminium and the coating.
- This double-layer procedure improves the service life of the coating and provides additional scratch-resistance.
- Very easy to clean after use.

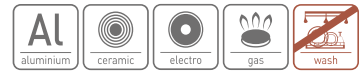

Primer coating: for anti-corrosion, anti-shock & better durability of coatings
 Titanium coating: for anti-scratch & anti-abrasion
 Mid coating: Whitford® Xylan non-stick
 Reinforcement of non stick and bright surface

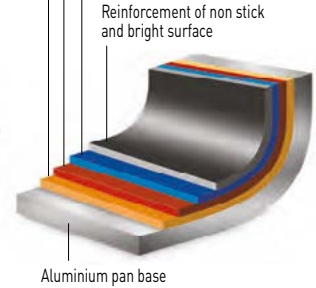

629109
 629307
 629390



FRYING PAN TITANIUM PROFESSIONAL

code	bottom (mm)	mm
629109	ø180	ø240x(H)55
629307	ø260	ø320x(H)55
629208	ø220	ø280x(H)55
629352	ø300	ø360x(H)55
629390	ø340	ø400x(H)55



839010

WOK TITANIUM PROFESSIONAL

code	bottom (mm)	mm
839010	ø157	ø320x(H)100



629505

SAUTÉ PAN TITANIUM PROFESSIONAL

code	bottom (mm)	mm
629505	ø225	ø280x(H)85



629802

GRILL PAN - RIDGED SURFACE TITANIUM PROFESSIONAL

code	bottom (mm)	mm
629802	ø220	550x290x(H)55



629604

FISH FRYING PAN - OVAL TITANIUM PROFESSIONAL

code	bottom (mm)	mm
629604	ø175	400x275x(H)35



629413

CRÊPES PAN TITANIUM PROFESSIONAL

code	bottom (mm)	mm
629413	ø260	ø320x(H)20



FRYING PANS ALUMINIUM ,MARBLE PROFESSIONAL'

- Made of durable aluminium, suitable for all heat sources, even suitable for use in ovens.
- Aluminum offers even heat conduction, the pan is quickly ready for use.
- The handle is made of epoxy coated steel.
- The 'Marble' non-stick coating has a high temperature resistance (up to 260°C).
- The coating is applied in three layers and is wear-resistant.
- Very easy to clean after use.

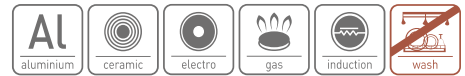

Midcoat improves the adhesive properties of the other layers

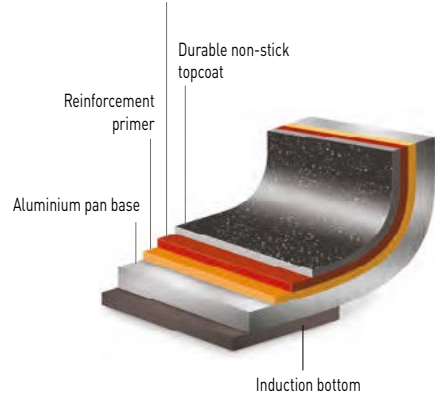

627600
627624
627655



FRYING PAN

code	bottom (mm)	mm
627600	ø140	ø200x(H)40
627617	ø180	ø240x(H)42
627662	ø200	ø260x(H)45
627624	ø220	ø280x(H)50
627631	ø260	ø320x(H)50
627648	ø280	ø360x(H)50
627655	ø300	ø390x(H)50



627747



627686



627716

WOK

code	bottom (mm)	mm
627730	ø210	ø280x(H)75
627747	ø210	ø320x(H)95

CRÊPES PAN

code	bottom (mm)	mm
627679	ø240	ø280x(H)25
627686	ø280	ø320x(H)20

FISH FRYING PAN - OVAL

code	bottom (mm)	mm
627716	ø185	280x400x(H)55

FRYING PANS ALUMINUM ,PLATINUM PROFESSIONAL'

- Made of durable aluminium, suitable for all heat sources.
- Aluminium excels at conducting heat, the pan is quickly ready for use.
- Stainless steel handle with insulating silicon handle for a good grip.
- The 'Teflon™ Platinum Plus' non-stick coating has a high temperature resistance (up to 260°C).
- The coating is applied in three layers which increases the wear resistance and makes the pan ideal for intensive use.
- Very easy to clean after use.



Midcoat improves the adhesive properties of the other layers

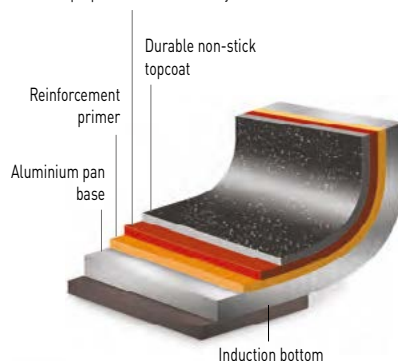

FRYING PANS

code	bottom (mm)	mm
621103	ø140	ø200x(H)44
621110	ø180	ø240x(H)50
621127	ø200	ø260x(H)52
621134	ø200	ø280x(H)52
621158	ø215	ø320x(H)60



PAELLA PAN

- Top-quality frying pans made of sheet steel.
- With 2 handles.

code	Suitable for Fiesta gas grill	mm
622100		ø340x(H)40
622308		ø460x(H)40
622407	146002	ø600x(H)40
622605	146804	ø800x(H)50





FRYING PANS TRADITIONAL

- Traditional frying pans made of rolled steel.
- Favourite pans of cooking masters.
- Simplicity, quality, firmness and versatility, features appreciated by many generations.
- Rusts easily, oil well to keep it ready for use.
- The handle is welded which ensures that it doesn't break.



FRYING PAN

code	bottom (mm)	mm
628638	ø180	ø240x(H)45
628614	ø220	ø280x(H)50
628706	ø240	ø300x(H)50
628621	ø260	ø320x(H)50



628621
628614
628638



Watch the video

CRÊPES PAN

code	bottom (mm)	mm
628805	ø200	ø230x(H)25

628805

BEFORE FIRST USE



Step 1
Put cooking oil in the pan and heat it. Add potato peelings and a lot of salt, then let it fry a bit.



Step 2
Take a kitchen towel and carefully rub the mixture around the inside of the pan.



Step 3
After rubbing the pan thoroughly, empty the pan. Now there will be residue of the potato peelings left in the pan.



Step 4
To remove the residue put a lot of salt in the pan and rub the salt around the pan with a kitchen towel to remove the residue. Don't do this on the stove.



Step 5
Remove the dirty salt, wipe the pan clean and pour a thin layer of oil in the pan.



Step 6
Spread the oil in the pan with a clean kitchen towel. The pan is now ready for first use or storage.



NEW

CAST IRON CASSEROLE ENAMELLED

- Made from cast iron, with red enamel coating on the outside.
- Lid with bumps on the inside that force water droplets (steam) to fall back, keeping the dish moist and aromatic.
- Suitable for all heat sources including induction.
- Not dishwasher safe.
- Available in different sizes; the smallest can be used as a serving dish [code: 626856].

code	liters	mm
626856	0.27	130x100x(H)48
626832	3.7	317x240x(H)105
626849	4.4	365x290x(H)115
626825	6.88	405x255x(H)134



626825





PAN SERIES COPPER

- 2,5 mm thick 3-ply construction consists of stainless steel (0,4 mm), aluminium (1,5 mm) and copper (0,4 mm).
- Handles are attached by rivets.



607060



607053

FRYING PAN

code	thickness (mm)	mm
607060	2.5	ø240x(H)50

SAUCEPAN - WITHOUT LID

code	liters	mm
607053	1.5	ø160x(H)80

MUSSEL & GRAVY PANS



625002



625057



MUSSEL PAN - WITH LID

- Black enamel.
- Flanged stainless steel rim.

code	max. contents in kg.	liters	mm
625606	0.5	0.8	ø140x(H)150
625002	1	2.3	ø200x(H)190
625057	1.5	3	ø220x(H)200
625101	2	5	ø260x(H)210



625804



625705

SOUP & GRAVY PAN - WITH LID

- Enamelled.
- Flanged stainless steel rim.
- Low lid.

code	-	liters	mm
625804	blue	0.5	ø115x(H)95
625705	black	0.65	ø135x(H)110



839003

18/8 stainless steel (0.4 mm)

aluminium (1,5 mm)

18/0 stainless steel (0.5 mm)



WOK 3-PLY - WITHOUT LID

- 3-Ply construction that sandwiches a layer of aluminium (1.5 mm) between an exterior layer of 18/0 stainless steel (0.5 mm) and an interior layer of 18/8 stainless steel (0,4 mm) from base to rim.
- Fast heating and excellent heat distribution.
- Very durable through high wear resistance.
- Long hollow handle made of stainless steel.
- Flat bottom of \varnothing 145 mm.

code	mm
839003	\varnothing 360x(H)90



ENAMELLED PAELLA PAN WITH COMPARTMENTS

- Pan is divided into compartments to allow simultaneous preparation of different dishes.

code	mm
622759	\varnothing 430x(H)47
622766	\varnothing 430x(H)47



622841



622858



622704



622728



622742

ENAMELLED PAELLA BOWLS

- Deep model.
- Enamelled sheet steel.

code	mm
622810	\varnothing 145x(H)40
622827	\varnothing 170x(H)40
622834	\varnothing 185x(H)43
622841	\varnothing 205x(H)57
622858	\varnothing 245x(H)70

ENAMELLED PAN

- With two convenient handles.
- Made of enamelled steel.

code	mm
622704	\varnothing 100x(H)20
622711	\varnothing 120x(H)25
622728	\varnothing 150x(H)27
622735	\varnothing 200x(H)36
622742	\varnothing 240x(H)40





GASTRONORM CONTAINERS



**GASTRONORM
CONTAINER
PROFI LINE**

**GASTRONORM
CONTAINER
KITCHEN LINE**

**GASTRONORM
CONTAINER
BUDGET LINE**

SUITABLE FOR:

Convection ovens	✓	✓	✓
Bain-marie system	✓	✓	✓
Chafing dishes	✓	✓	✓
Refrigerators	✓	✓	✓
Food storage	✓	✓	✓
Dishwasher cleaning	✓	✓	✓

PROPERTIES:

For use at temperatures	-40°C / 300°C	-40°C / 300°C	-40°C / 300°C
Stackable	✓	✓	✓

CONSTRUCTION:

Made of	stainless steel 18/10	stainless steel	stainless steel
Thickness (mm)	0,6-0,8	0,6-0,7	0,6-0,7
Available heights (mm)	20 up to 200	20 up to 200	20 up to 200

ACCESSORIES:

Perforated containers	✓	✓	
Lids	✓	✓	✓
Lids with silicone rim	✓	✓	✓
Lids with spoon recess	✓	✓	
Dripping tray		✓	
Adaptor bar	✓	✓	✓

ADDITIONAL INFO:

Easy to clean	✓	✓	✓
Gastronorm size engraved		✓	
With capacity scale			
Doesn't absorb odours or flavours	✓	✓	✓

Compliant with the most strict food contact regulations (for hospitals)

- Excellent corrosion resistance (salt & sour resistant)

- Reduced radius to ensure maximum content

- Very strong and durable

Reinforced corners to add strenght

- If treated correctly corrosion resistant

If treated correctly corrosion resistant

PAGE

37

40

42



**GASTRONORM CONTAINER
POLYCARBONATE
BLACK & WHITE**

**GASTRONORM CONTAINER
POLYPROPYLENE**

**HACCP STORAGE
CONTAINER**

**PORCELAIN
CONTAINER**

			✓
✓	✓	✓	✓
✓	✓	✓	✓
✓	✓	✓	✓
-40°C / 110°C	-40°C / 80°C	-40°C / 80°C	under 600°C
✓	✓	✓	✓
polycarbonate	polypropylene	polypropylene	porcelain
2-3	2-2,9	2-2,9	
65 up to 150	100 up to 200	65 up to 200	20 up to 65
✓	✓	✓	
	✓		
✓	✓	✓	✓
✓	✓	✓	
✓	✓	✓	✓
Perfect for presentation	Transparent material	With integrated HACCP label for monitoring of food storage process	Special porcelain type, toughest type available
• High impact resistance, very durable		• Transparent material	• Thermal shock resistant, can withstand extreme temperature changes
		• Coloured lid clips according to HACCP sold separately	• High-impact and wear resistance and still relatively light-weight
			• Extremely pure and brilliant white
44-45	46	47	396





GN GASTRONORM SYSTEM

- Designation of standard size containers used in food industry, determined in PN-EN 631-1:1996 standard.
- Standardisation of container dimensions makes it easier to use them in various kitchen appliances which are designed based on these dimensions, e.g. in ovens, insulated containers, refrigerated cabinets, bain-maries, transport trolleys



height (mm)



DIMENSIONS OF GN CONTAINERS:

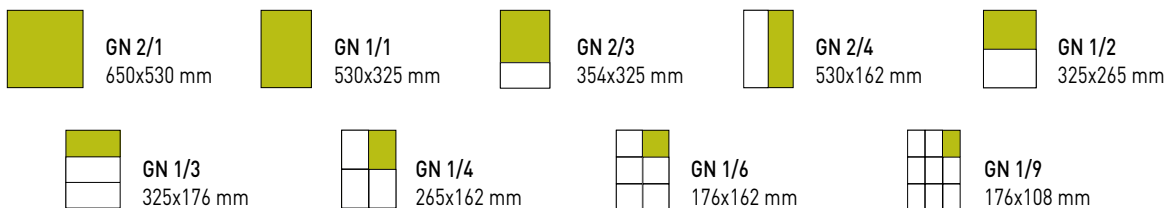

GASTRONORM CONTAINERS PROFI LINE

- Made of high grade stainless steel 18/10.
- Very solid design.
- Smooth edges, easy to clean.
- Can be used in convection ovens, refrigerators, bain-marie systems and chafing dishes.



Very strong and durable.

For use at temperatures
-40°C / 300°C.

Excellent resistance to corrosion.

Reduced inner radius increases
maximum capacity.

GN 2/1	GN 1/1	GN 1/2	GN 1/3	GN 1/4	GN 1/6	GN 1/9
650x530 mm	530x325 mm	325x265 mm	325x176 mm	265x162 mm	176x162 mm	176x108 mm



2/1

801123



1/1

801222



2/3

801314

code	liters	thickness (mm)	height (mm)
801109	58	0.8	200
801116	43	0.8	150
801123	30	0.8	100
801130	19	0.8	65
801147	11	0.8	40
801154	5.5	0.8	20

code	liters	thickness (mm)	height (mm)
801208	28	0.8	200
801215	21	0.8	150
801222	14	0.8	100
801239	9	0.8	65
801246	5	0.8	40
801253	2.5	0.8	20

code	liters	thickness (mm)	height (mm)
801307	18	0.8	200
801314	13	0.8	150
801321	9	0.7	100
801338	5.5	0.7	65
801345	3	0.7	40
801352	1.5	0.7	20



2/4

801666



1/2

801420



1/3

801529

code	liters	thickness (mm)	height (mm)
801840	8.6	0.7	150
801666	5.8	0.7	100
801857	4	0.7	65
801864	2.5	0.7	40
801871	1.2	0.7	20

code	liters	thickness (mm)	height (mm)
801406	12.5	0.8	200
801413	9.5	0.7	150
801420	6.5	0.7	100
801437	4	0.7	65
801444	2	0.7	40
801451	1	0.7	20

code	liters	thickness (mm)	height (mm)
801505	7.8	0.8	200
801512	5.7	0.7	150
801529	4	0.7	100
801536	2.5	0.7	65
801543	1.5	0.7	40
801550	0.8	0.7	20



1/4



801628

code	liters	thickness (mm)	height (mm)
801635	1.8	0.7	65
801604	5.5	0.8	200
801611	4	0.7	150
801628	2.8	0.7	100
801642	1.7	0.7	40
801659	0.9	0.7	20

1/6



801727

code	liters	thickness (mm)	height (mm)
801703	3.4	1	200
801710	2.4	0.8	150
801727	1.6	0.7	100
801734	1	0.7	65

1/9



801826

code	liters	thickness (mm)	height (mm)
801826	1	0.7	100
801833	0.6	0.7	65

GASTRONORM CONTAINERS PROFI LINE

1/1



802229

- Perforated bottom.
- Perforated sides with a height of 100mm or higher.

code	liters	thickness (mm)	height (mm)
802205	28	0.8	200
802212	21	0.8	150
802229	14	0.8	100

2/3



802328

- Perforated bottom.
- Perforated sides with a height of 100mm or higher.

code	liters	thickness (mm)	height (mm)
802328	9	0.7	100

1/2



802427

- Perforated bottom.
- Perforated sides with a height of 100mm or higher.

code	liters	thickness (mm)	height (mm)
802427	6.5	0.7	100



802236

- Perforated bottom.

code	liters	thickness (mm)	height (mm)
802236	9	0.8	65
802243	5	0.8	40
802168	2.5	0.8	20



802342

- Perforated bottom.

code	liters	thickness (mm)	height (mm)
802335	5.5	0.7	65
802342	3	0.7	40



802441

- Perforated bottom.

code	liters	thickness (mm)	height (mm)
802434	4	0.7	65
802441	2	0.7	40

1/3



802526

- Perforated bottom.
- Perforated sides with a height of 100mm or higher.

code	liters	thickness (mm)	height (mm)
802502	7.8	0.7	200
802519	5.7	0.7	150
802526	4	0.7	100



802533

- Perforated bottom.

code	liters	thickness (mm)	height (mm)
802533	2.5	0.7	65
802540	1.2	0.7	40



808108

808153

ADAPTOR BAR FOR GN CONTAINERS

- For fitting small GN-containers in bain-maries, chafing dishes etc.

code	GN	mm
808108	GN 1/2	325x22x(H)10
808153	GN 1/1	530x22x(H)10



804100

LID FOR GN CONTAINERS

- Fits on HENDI Profi Line and Polycarbonate GN containers.

code	thickness (mm)	GN	mm
804100	0.8	GN 1/1	530x325
804117	0.7	GN 2/3	354x325
804179	0.8	GN 2/4	530x162
804124	0.7	GN 1/2	265x325
804131	0.7	GN 1/3	325x176
804148	0.7	GN 1/4	265x162
804155	0.7	GN 1/6	176x162
804162	0.7	GN 1/9	176x108

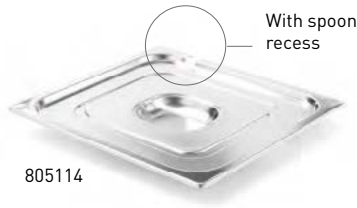

805114

LID FOR GN CONTAINERS WITH SPOON RECESS

- Fits on HENDI Profi Line and Polycarbonate GN containers.

code	thickness (mm)	GN	mm
805138	0.7	GN 1/3	325x176
805107	0.7	GN 1/1	530x325
805114	0.7	GN 2/3	354x325
805121	0.7	GN 1/2	265x325
805145	0.7	GN 1/4	265x162
805152	0.7	GN 1/6	176x162



802601

LID FOR GN CONTAINERS WITH SILICONE RIM

- With silicone rim for airtight sealing.
 - Only suitable for 'Profi-Line' and polycarbonate gastronorm containers.
 - The airtight cover structure helps keep food fresh and avoid leaking during transportation.

code	GN	mm
802601	GN 1/1	530x325
802618	GN 2/3	354x325
802625	GN 1/2	265x325
802632	GN 1/3	325x176
802649	GN 1/4	265x162
802656	GN 1/6	176x162



864210

LID FOR GN CONTAINERS WITH SOUS VIDE STICK RECESS

- With recess for sous vide stick 222645.
 - Also suitable for stainless steel Profi Line Gastronorm containers.

code	GN	mm
864210	GN 1/2	265x325
864203	GN 1/1	530x325

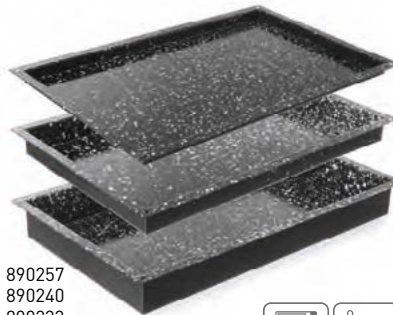

890257
890240
890233

GASTRONORM CONTAINER ENAMELLED

code	GN	mm
890257	GN 1/1	530x325x(H)20
890240	GN 1/1	530x325x(H)40
890233	GN 1/1	530x325x(H)60

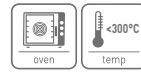

890356
890349

GASTRONORM CONTAINER ENAMELLED GN 2/3

code	GN	mm
890356	GN 2/3	345x325x(H)20
890349	GN 2/3	345x325x(H)40

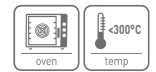

805558
805541
805534



CONTAINER WITH NON-STICK COATING

code	GN	mm
805558	GN 1/1	530x325x(H)20
805541	GN 1/1	530x325x(H)40
805534	GN 1/1	530x325x(H)65



809259
809242

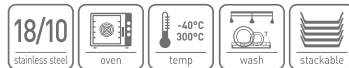

GASTRONORM TRAY PROFI LINE

code	GN	mm
809259	GN 1/1	530x325x(H)20
809242	GN 1/1	530x325x(H)40



809150

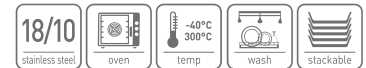

GASTRONORM TRAY PROFI LINE GN 2/1

code	GN	mm
809150	GN 2/1	650x530x(H)20



GASTRONORM CONTAINERS KITCHEN LINE

- Extra strong due to reinforced corners.
- Gastronorm size is engraved.
- Smooth edges, easy to clean.
- Can be used in convection ovens, refrigerators, bain-marie systems and chafing dishes.



Extra strong due to reinforced corners.

For use at temperatures -40°C / 300°C.

Corrosion-resistant (when used properly).

Thickness 0,6-0,7 mm.

GN 2/1	GN 1/1	GN 2/3	GN 1/2	GN 1/3	GN 1/4	GN 1/6	GN 1/9
650x530 mm	530x325 mm	354x325 mm	325x265 mm	325x176 mm	265x162 mm	176x162 mm	176x108 mm

1/1



806142

code	liters	thickness (mm)	height (mm)
806159	28	0.7	200
806142	21	0.7	150
806135	14	0.6	100
806128	9	0.6	65
806111	5	0.6	40
806104	2.5	0.6	20

2/3



806241

code	liters	thickness (mm)	height (mm)
806258	15.5	0.7	200
806241	13	0.7	150
806234	9	0.6	100
806227	5.5	0.6	65
806210	3	0.6	40
806203	1.5	0.6	20

1/2



806340

code	liters	thickness (mm)	height (mm)
806357	12.5	0.7	200
806340	9.5	0.7	150
806333	6.5	0.6	100
806326	4	0.6	65
806319	2	0.6	40
806302	1	0.6	20

1/3



806449

code	liters	thickness (mm)	height (mm)
806449	5.7	0.7	150
806456	7.8	0.7	200
806432	4	0.6	100
806425	2.5	0.6	65
806418	1.5	0.6	40
806401	0.6	0.6	20

1/4



806548

code	liters	thickness (mm)	height (mm)
806555	5.5	0.7	200
806548	4	0.7	150
806531	2.8	0.6	100
806524	1.8	0.6	65

1/6



806647

code	liters	thickness (mm)	height (mm)
806654	3.4	0.7	200
806647	2.4	0.7	150
806630	1.6	0.6	100
806623	1	0.6	65

1/9



806739

code	liters	thickness (mm)	height (mm)
806739	1	0.7	100
806722	0.6	0.6	65

CONTAINERS PERFORATED

1/1



807132

code	liters	thickness (mm)	height (mm)
807132	14	0.6	100

2/3



807224

code	liters	thickness (mm)	height (mm)
807224	5.5	0.6	65

806197



PERFORATED DRIP SHELF FOR GN CONTAINERS

code	GN
806296	GN 2/3
806197	GN 1/1
806395	GN 1/2
806494	GN 1/3
806593	GN 1/4
806692	GN 1/6



807118

- Perforated bottom.

code	liters	thickness (mm)	height (mm)
807125	9	0.6	65
807118	5	0.6	40

1/2



807330

code	liters	thickness (mm)	height (mm)
807330	6.5	0.6	100
807323	4	0.6	65

808153



808108

ADAPTOR BAR FOR GN CONTAINERS

- For fitting small GN-containers in bain-maries, chafing dishes etc.

code	GN	mm
808108	GN 1/2	325x22x(H)10
808153	GN 1/1	530x22x(H)10

Adaptor bar for fitting small GN-containers in bain-maries, chafing dishes, salad counters etc.



LID FOR GN CONTAINERS

code	thickness (mm)	GN	mm
806814	0.7	GN 1/1	530x325
806821	0.7	GN 2/3	354x325
806838	0.7	GN 1/2	265x325
806845	0.7	GN 1/3	325x176
806852	0.7	GN 1/4	265x162
806869	0.7	GN 1/6	176x162
806876	0.7	GN 1/9	176x108

LID FOR GN CONTAINERS WITH SOUP/SAUCE LADLE RECESS

code	thickness (mm)	GN	mm
806913	0.7	GN 1/1	530x325
806920	0.7	GN 2/3	354x325
806937	0.7	GN 1/2	265x325
806944	0.7	GN 1/3	325x176
806951	0.7	GN 1/4	265x162
806968	0.7	GN 1/6	176x162
806975	0.7	GN 1/9	176x108



GASTRONORM CONTAINERS BUDGET LINE

- Very solid design.
- Smooth edges, easy to clean.
- Intended for use in convection ovens, refrigerators, bain-marie systems and chafing dishes.

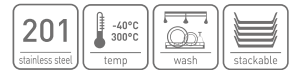

For use at temperatures
-40°C / 300°C.

Corrosion-resistant
(when used properly).

Thickness 0,6-0,7 mm.

GN 1/1	GN 1/2	GN 1/3	GN 1/4	GN 1/6	GN 1/9
530x325 mm	325x265 mm	325x176 mm	265x162 mm	176x162 mm	176x108 mm

1/1



800133

code	liters	height (mm)
800157	28	200
800140	21	150
800133	14	100
800126	9	65
800119	5	40
800102	2.5	20

2/3



800232

code	liters	height (mm)
800225	5.5	65
800249	13	150
800232	9	100
800218	3	40

1/2



800331

1/3



800430

1/4



800539

code	liters	height (mm)	code	liters	height (mm)	code	liters	height (mm)
800355	12.5	200	800454	7.8	200	800553	5.5	200
800348	9.5	150	800447	5.7	150	800546	4	150
800331	6.5	100	800430	4	100	800539	2.8	100
800324	4	65	800423	2.5	65	800522	1.8	65
800317	2	40	800416	1.5	40			
800300	1	20	800409	0.8	20			

1/6



800638

code	liters	height (mm)
800652	3.4	200
800645	2.4	150
800638	1.6	100
800621	1	65

1/9



800737

code	liters	height (mm)
800737	1	100
800720	0.6	65

LID FOR GN CONTAINERS WITH SILICONE RIM

- With silicone rim for airtight sealing.
- The airtight cover structure helps keep food fresh and avoid leaking during transportation.
- Fits on Gastronorm container Kitchen & Budget Line

code	GN	mm
807637	GN 1/3	325x176
807606	GN 1/1	530x325
807613	GN 2/3	354x325
807620	GN 1/2	265x325
807651	GN 1/6	176x162
807644	GN 1/4	265x162



807606

GASTRONORM CONTAINERS BUDGET LINE WITH HANDLES

1/1



817148

2/3



817247

code	liters	height (mm)	code	liters	height (mm)
817155	28	200	817254	17	200
817148	21	150	817247	13	150



1/2



817346

1/3



817445

code	liters	height (mm)	code	liters	height (mm)
817353	12.5	200	817452	7.8	200
817346	9.5	150	817445	5.7	150



817810

LID FOR GN CONTAINERS

code	GN	mm
817834	GN 1/2	325x265
817841	GN 1/3	325x176
817810	GN 1/1	530x325
817827	GN 2/3	354x325



GASTRONORM CONTAINERS POLYCARBONATE BLACK

- High quality professional Gastronorm containers made of black polycarbonate.
- Doesn't absorb odours or flavours.
- Temperature resistant from -40°C to 110°C.



For use at temperatures
-40°C / 110°C

Gradated

GN 1/1	GN 1/2	GN 1/3	GN 1/4	GN 1/6	GN 1/9
530x325 mm	325x265 mm	325x176 mm	265x162 mm	176x162 mm	176x108 mm

1/1



862209

code	liters	height (mm)
862216	21	150
862223	14	100
862209	9	65

1/2



862421

code	liters	height (mm)
862407	12.5	200
862414	9.5	150
862421	6.5	100
862438	4	65

1/3



862513

code	liters	height (mm)
862506	7.8	200
862513	5.7	150
862520	4	100
862537	2.5	65

1/4



862629

code	liters	height (mm)
862612	4	150
862629	2.8	100
862636	1.8	65

1/6



862711

code	liters	height (mm)
862704	3.4	200
862711	2.4	150
862728	1.6	100
862735	1	65

1/9



862827

code	liters	height (mm)
862827	1	100



862902



804100

LID FOR GN CONTAINERS BLACK POLYCARBONATE

code	GN	mm
862902	GN 1/1	530x325
862926	GN 1/2	325x265
862933	GN 1/3	325x176
862940	GN 1/4	265x162
862957	GN 1/6	176x162

LID FOR GN CONTAINERS

- Fits on HENDI Profi Line and Polycarbonate GN containers.

code	thickness (mm)	GN	mm
804100	0.8	GN 1/1	530x325
804117	0.7	GN 2/3	354x325
804179	0.8	GN 2/4	530x162
804124	0.7	GN 1/2	265x325
804131	0.7	GN 1/3	325x176
804148	0.7	GN 1/4	265x162
804155	0.7	GN 1/6	176x162
804162	0.7	GN 1/9	176x108

GASTRONORM CONTAINERS POLYCARBONATE WHITE

- High quality professional Gastronorm containers made of white polycarbonate.
- Doesn't absorb odours or flavours.
- Temperature resistant from -40°C to 110°C.

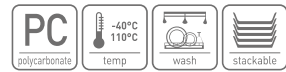

For use at temperatures
-40°C / 110°C

Gradated



GN 1/1	GN 1/2	GN 1/3	GN 1/4	GN 1/6	GN 1/9
530x325 mm	325x265 mm	325x176 mm	265x162 mm	176x162 mm	176x108 mm

1/1



862285

code	liters	height (mm)
862285	9	65

1/2



862476

code	liters	height (mm)
862483	4	65
862476	6.5	100

1/3



862575

code	liters	height (mm)
862568	5.7	150
862575	4	100
862582	2.5	65

1/4



862674

code	liters	height (mm)
862674	2.8	100
862681	1.8	65

1/6



862773

code	liters	height (mm)
862766	2.4	150
862773	1.6	100
862780	1	65

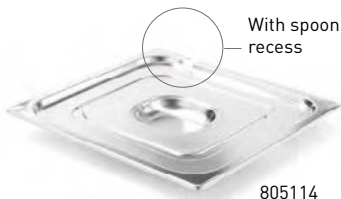

With spoon
recess

805114

LID FOR GN CONTAINERS WITH SPOON RECESS

- Fits on HENDI Profi Line and Polycarbonate GN containers.

code	thickness (mm)	GN	mm
805138	0.7	GN 1/3	325x176
805107	0.7	GN 1/1	530x325
805114	0.7	GN 2/3	354x325
805121	0.7	GN 1/2	265x325
805145	0.7	GN 1/4	265x162
805152	0.7	GN 1/6	176x162



862964

LID FOR GN CONTAINERS WHITE POLYCARBONATE

code	GN	mm
862919	GN 1/1	530x325
862964	GN 1/2	265x325
862971	GN 1/3	325x176
862988	GN 1/4	265x162
862995	GN 1/6	176x162



GASTRONORM CONTAINERS POLYCARBONATE TRANSPARENT

- High quality professional Gastronorm containers made of transparent polycarbonate.
- Doesn't absorb odours or flavours.
- Temperature resistant from -40°C to 110°C.



GN 2/1	GN 1/1	GN 1/2	GN 1/3	GN 1/4	GN 1/6	GN 1/9
650x530 mm	530x325 mm	325x265 mm	325x176 mm	265x162 mm	176x162 mm	176x108 mm

code	liters	height (mm)
861196	58	200



code	liters	height (mm)
861202	28	200
861219	21	150
861226	14	100
861233	9	65

code	liters	height (mm)
861400	12.5	200
861417	9.5	150
861424	6.5	100
861431	4	65

code	liters	height (mm)
861509	7.8	200
861516	5.7	150
861523	4	100
861530	2.5	65



code	liters	height (mm)
861608	5.5	200
861615	4	150
861622	2.8	100
861639	1.8	65

code	liters	height (mm)
861707	3.4	200
861714	2.4	150
861721	1.6	100
861738	1	65

code	liters	height (mm)
861820	1	100
861837	0.6	65



LID FOR GN CONTAINERS

- Without spoon recess.
- Also suitable for stainless steel Profi Line Gastronorm containers.

code	GN	mm
864098	GN 2/1	650x530
864104	GN 1/1	530x325
864128	GN 1/2	265x325
864135	GN 1/3	325x176
864142	GN 1/4	265x162
864159	GN 1/6	176x162
864166	GN 1/9	176x108



PERFORATED DRIP SHELF FOR GN CONTAINERS POLYCARBONATE

code	GN	mm
868522	GN 1/1	467x263
868546	GN 1/2	265x206
868553	GN 1/3	266x116
868577	GN 1/6	118x106



LID FOR GN CONTAINERS WITH SOUS VIDE STICK RECESS

- With recess for sous vide stick 222645.
- Also suitable for stainless steel Profi Line Gastronorm containers.

code	GN	mm
864210	GN 1/2	265x325
864203	GN 1/1	530x325

GASTRONORM CONTAINERS POLYPROPYLENE PROFI LINE

- Doesn't absorb odours or flavours.
- Temperature resistant from -40°C to 80°C.

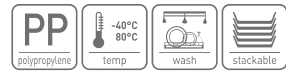

GN 1/1	GN 1/2	GN 1/3	GN 1/4	GN 1/6	GN 1/9
530x325 mm	325x265 mm	325x176 mm	265x162 mm	176x162 mm	176x108 mm

1/1



880012

1/2



880111

1/3



880210

code	liters	height (mm)
880005	28	200
880012	21	150
880029	14	100

code	liters	height (mm)
880104	12.5	200
880111	9.5	150
880128	6.5	100

code	liters	height (mm)
880203	7.8	200
880210	5.7	150
880227	4	100

1/4



880319

1/6



880418

1/9



880524

code	liters	height (mm)
880302	5.5	200
880319	4	150
880326	2.8	100

code	liters	height (mm)
880401	3.4	200
880418	2.4	150
880425	1.6	100

code	liters	height (mm)
880524	1	100



SIL
silicone

881811

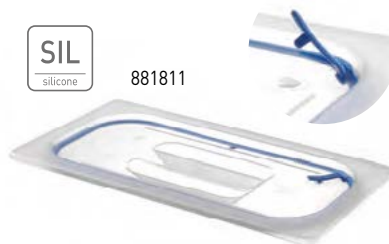

LID FOR GN CONTAINERS POLYPROPYLENE

- Suitable for all HENDI polypropylene Gastronorm containers, including HACCP storage containers.

code	GN	mm
880609	GN 1/1	530x325
880616	GN 1/2	325x265
880623	GN 1/3	325x176
880630	GN 1/4	265x162
880647	GN 1/6	176x162
880654	GN 1/9	176x108

LID FOR GN CONTAINERS MADE OF POLYPROPYLENE, WITH SEAL

- Lid with hermetic santoprene seal; the seal is tight enough to prevent leaking when the container is tilted.
- With lip to break the airtight seal for easy opening.
- Fits on HENDI GN containers Polypropylene

code	GN	mm
881828	GN 1/3	325x176
881804	GN 1/1	530x325
881811	GN 1/2	325x265
881835	GN 1/4	265x162
881842	GN 1/6	176x162
881859	GN 1/9	176x108



GASTRONORM STORAGE CONTAINERS HACCP

- Gastronorm containers only - lids not included.
- Airtight sealing.
- Doesn't absorb odours or flavours Lids and lid clips (green, yellow, blue, red or purple as per HACCP guidelines) available separately.
- Wear-proof label for monitoring of food storage process.
- Special erasable markers to write on the labels are not included.
- Temperature resistant from -40°C to 80°C.

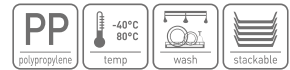

GN 1/1	GN 1/2	GN 1/3	GN 1/4	GN 1/6	GN 1/9
530x325 mm	325x265 mm	325x176 mm	265x162 mm	176x162 mm	176x108 mm

1/1



880050

1/2



880159

code	liters	height (mm)
880050	28	200
880067	21	150
880074	12	100
880036	9	65

code	liters	height (mm)
880159	12.5	200
880166	9.5	150
880173	6.5	100

1/3



880258

code	liters	height (mm)
880258	7.8	200
880265	5.7	150
880272	4	100
880289	2.5	65

1/4



880371

code	liters	height (mm)
880357	5.5	200
880364	4	150
880371	2.8	100
880388	1.8	65

1/6



880456

code	liters	height (mm)
880456	3.4	200
880463	2.4	150
880470	1.6	100
880487	1	65

1/9



880555

code	liters	height (mm)
880555	0.9	100
880562	0.6	65



880623

LID FOR GN CONTAINERS POLYPROPYLENE

- Suitable for all HENDI polypropylene Gastronorm containers, including HACCP storage containers.

code	GN	mm
880609	GN 1/1	530x325
880616	GN 1/2	325x265
880623	GN 1/3	325x176
880630	GN 1/4	265x162
880647	GN 1/6	176x162
880654	GN 1/9	176x108



881705

LID FOR GN CONTAINERS PURPLE

- Suitable for all HENDI polypropylene Gastronorm containers, including HACCP storage containers.

code	GN	mm
881705	GN 1/1	530x325
881712	GN 1/2	325x265
881729	GN 1/3	325x176
881736	GN 1/4	265x162
881743	GN 1/6	176x162
881750	GN 1/9	176x108

LID CLIPS FOR HACCP STORAGE CONTAINERS

- 12 pcs. in blister pack

code	colour	packed per
880661	Red	12
880678	Green	12
880685	Yellow	12
880692	Blue	12
880869	Purple	12



HORECA MARKERS

- 2 pieces on blistercard.
- For writing on food containers.
- Erasable.

code	packed per
871546	2



871546



**VERY HARD
POLY-
ETHYLENE**

CUTTING BOARD HACCP



- Made of polyethylene HDPE 500.
- Meets HACCP standards.
- Both sides suitable for cutting.
- Can be cleaned in professional dishwashers (short program).



826201



CUTTING BOARD RACK

- For 6 cutting boards up to 20 mm thick.

code	mm
826201	303x211x(H)205

CUTTING BOARD HACCP 600X400

code	colour	mm	thickness [mm]
825600	White	600x400	18
825617	Red	600x400	18
825624	Blue	600x400	18
825631	Green	600x400	18
825648	Brown	600x400	18
825655	Yellow	600x400	18
825662	Purple	600x400	18

CUTTING BOARD HACCP 450X300

code	colour	mm	thickness [mm]
825518	White	450x300	13
825525	Red	450x300	13
825532	Blue	450x300	13
825549	Green	450x300	13
825556	Brown	450x300	13
825563	Yellow	450x300	13
825570	Purple	450x300	13

CUTTING BOARD HACCP

- Made of polyethylene HDPE 500.
- Meets HACCP standards.
- Both sides suitable for cutting.
- Can be cleaned in professional dishwashers (short program).

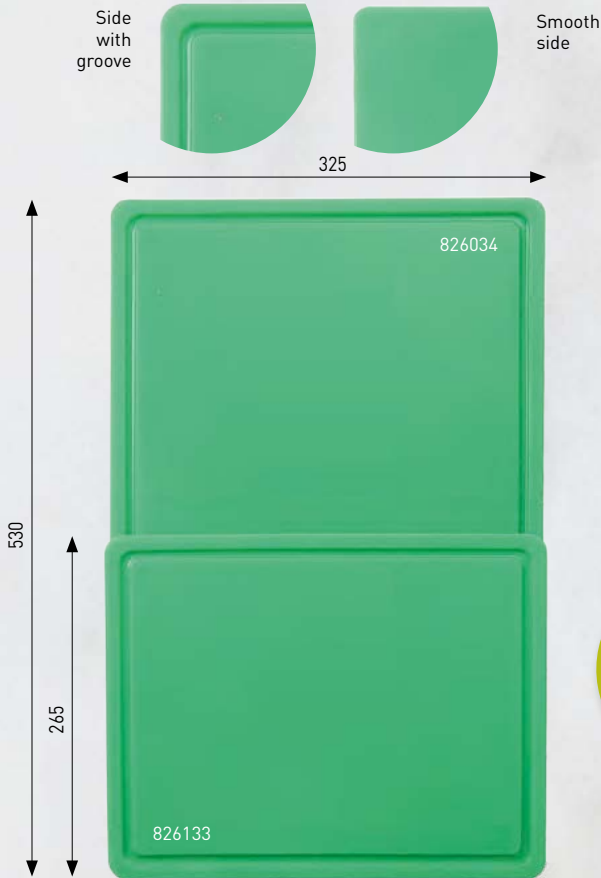

**VERY HARD
POLY-
ETHYLENE**



CUTTING BOARD HACCP GASTRONORM 1/1

- One side smooth and other side with groove.

code	colour	mm	thickness (mm)
826003	White	530x325	15
826010	Red	530x325	15
826027	Blue	530x325	15
826034	Green	530x325	15
826041	Brown	530x325	15
826058	Yellow	530x325	15
826065	Purple	530x325	15

Groove to prevent leaking



CUTTING BOARD HACCP GASTRONORM 1/2

- One side smooth and other side with groove.

code	colour	mm	thickness (mm)
826102	White	325x265	12
826119	Red	325x265	12
826126	Blue	325x265	12
826133	Green	325x265	12
826140	Brown	325x265	12
826157	Yellow	325x265	12
826164	Purple	325x265	12
826171	Black	325x265	12





CUTTING BOARD HACCP GASTRONORM 1/2

code	colour	mm	thickness (mm)
826706	White	265x325	9
826713	Red	265x325	9
826720	Blue	265x325	9
826737	Green	265x325	9
826744	Brown	265x325	9
826751	Yellow	265x325	9



Flexible

826300



HACCP CUTTING MAT SET - 6 PIECES

- Colour coded set of 6 mats to facilitate kitchen hygiene.
- White, red, blue, green, brown, yellow.
- Flexible, allowing easy pouring of cut products.
- Lightweight and easy to store and transport.

code	thickness (mm)	mm
826300	1	380x305x(H)6



506912

506905

CUTTING BOARD

- Rubberwood.
- With handles.

code	mm
506905	530x325x(H)45
506912	265x325x(H)45



598047

ANTI-SLIP MAT

- Multifunctional anti-slip mat.
- Made of PVC foam.
- Easy to cut to size.
- Wash by hand at 40°C.
- Not suitable for direct food contact.

code	mm
598047	1500x300



505205



505106



826485

826348



CARVING BOARD

- Solid beech wood.
- Grooved.

code	thickness (mm)	mm
505205	16	390x230

CUTTING BOARD WITH GRIP

- Solid beech wood.

code	thickness (mm)	mm
505106	13	390x160

CUTTING BOARD WITH HANDLE

- Made of polyethylene HDPE.
- Both sides suitable for cutting.

code	colour	mm	thickness (mm)
826348	White	250x150	10
826478	Black	250x150	10
826355	White	300x200	10
826485	Black	300x200	10



505502

Removable grid
- easy to clean



BREAD CUTTING BOARD

- Made of natural wood in a dark shade.
- Removable grid - horizontal rifling.
- 4 non-slip feet ensuring stability during cutting.
- Not dishwasher safe.

code	thickness (mm)	mm
505502	20	475x322



570906

ONION GOGGLES

- Wear the goggles during the cutting of onions to prevent teary eyes.

code	mm
570906	150x160x(H)45



BUTCHER BLOCK HDPE

- Made of HDPE500 polyethylene.

code	mm
505663	500x400x(H)80
505656	500x400x(H)50

BASE FOR BUTCHER BLOCK

- Base for HENDI butcher block HDPE.
- With in height adjustable feet for level instalment.

code	mm
505670	500x400x(H)750

POLYETHYLENE BUTCHER BLOCK WITH BASE

- Made of HDPE500 polyethylene.
- Stainless steel stand.

code	mm
505687	500x400x(H)800



505656

505670

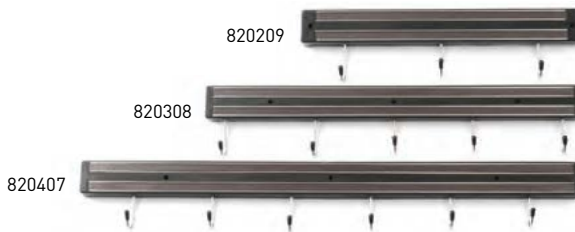

820407

KNIFE MAGNET WITH HOOKS

- With 2 magnetic strips.

code	-	mm
820407	6 hooks	(L)620
820209	3 hooks	(L)340
820308	5 hooks	(L)470



513750



TAB GRABBER

- Made of glossy aluminium.
- Mounted with screws or adhesive.

code	mm
513736	(L)455
513705	(L)610
513712	(L)915
513743	(L)1015
513750	(L)1220





KNIVES PROFI LINE

- All knives are precision hot drop forged from a single blank of high carbon German stainless steel.
- The specialized Chromium-Molybdenum-Vanadium surgical alloy steel X50CrMoV15 guarantees the following characteristics: - razor sharp - long-lasting cutting edge - easily restorable edge - high stain resistance. Some 50 major manufacturing steps are required to produce each knife.
- Traditional skills and precision machinery continue the grinding and polishing operations until the final cutting edge is applied at the most appropriate blade angle.
- The handle combines balance, safety, heft and control with an exclusive look.
- Each knife is individually packed in a PET presentation blister.



code			thickness (mm)	blade length (mm)	length (mm)
844205	1	Cook's knife	3,3	250	390
844212	2	Chef's knife	3,3	200	335
844311	3	Carving knife	2,7	250	380
844304	4	Carving knife	2,6	200	332
844229	5	Carving fork	9	150	285
844267	6	Boning knife, Flexible.	2	150	270
844250	7	Utility knife	2	150	265

code			thickness (mm)	blade length (mm)	length (mm)
844236	8	Paring knife	1,9	90	195
844328	9	Ham/salmon knife, half flexible, granton	2,6	300	430
844298	10	Bread knife	2,4	215	340
844281	11	Bread knife	2,4	215	340
844335	12	Cleaver, granton	3	165	300
844274	13	Santoku knife, granton	3	180	310
844403	14	Knife sharpener diamond		310	450



S.S. stainless steel
POM POM plastic

KNIVES KITCHEN LINE

- Made of one piece of hard, forged chrome molybdenum steel.
- Due to the highest quality of the workmanship, Hendi knives are durable and resistant to corrosion with long-lasting sharpness of the blade.

- A unique design of the handle prevents depositing of food residues in the handle/blade transition area.
- Each knife is individually packed in a PET presentation blister.
- With safe, profiled black POM plastic handle.



code			blade length (mm)	length (mm)
781319	1	Chef's knife	200	340
781357	2	Chef's knife	150	285
781340	3	Carving knife	200	330
781364	4	Carving fork	175	290
781371	5	Boning knife	150	285
781333	6	Bread knife	210	335

code			blade length (mm)	length (mm)
781388	7	Kitchen knife	125	240
781395	8	Paring knife	90	200
781401	9	Poultry shears	140	260
781302	10	Cleaver	180	300
781326	11	Ham/salmon knife	215	350
781418	12	Knife sharpener	230	350





**ERGONOMIC
NON SLIP
HANDLE**

PP polypropylene
S.S. stainless steel

BLACK - UNIVERSAL

- Polypropylene handle in accordance with HACCP guidelines.

Granton indentations for non-stick cutting

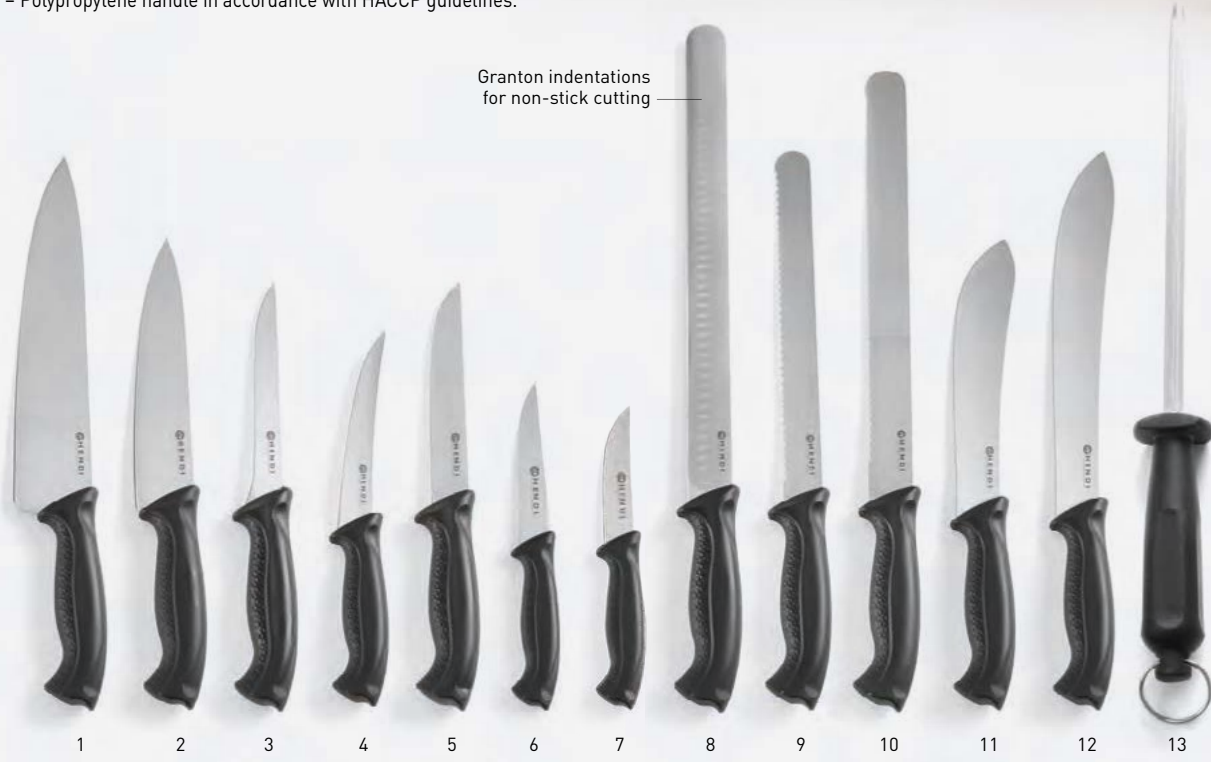

code			thickness (mm)	blade length (mm)	length (mm)
842706	1	Cook's knife	2,5	240	380
842607	2	Koksmes	2,5	180	320
844441	3	Boning knife	1,8	150	280
844434	4	Fillet knife	1,8	150	260
842409	5	Carving knife	2,5	150	290
842102	6	Universal knife	1,2	100	210
842201	7	Universal knife	1,2	90	200

code			thickness (mm)	blade length (mm)	length (mm)
842904	8	Ham/kebab knife with the Granton edge	1,7	350	490
843000	9	Bread knife	1,5	250	380
843109	10	Bread knife	1,5	300	430
844427	11	Butcher's knife	2,5	200	330
844410	12	Butcher's knife	2,5	250	380
781418	13	Knife sharpener		230	350



Watch the video



JAPANESE KNIVES

- Top end series of drop forged knives.
- Made of the high carbon steel alloy X50CrMoV15.
- Produced in 50 major manufacturing steps.
- Traditional wooden handle.
- Each knife is individually packed in a PET presentation blister.
- Limited edition, specially made for HENDI.

code			thickness (mm)	blade length (mm)	length (mm)
845035	1	Knife ‚Santoku‘	4	165	295
845028	2	Vegetable knife ‚Usuba‘	4	180	325
845059	3	Knife ‚Sashimi‘	3	210	340
845042	4	Knife ‚Sashimi‘	4	240	370



9-PIECE KNIVES SET

- Made of one piece of hard, stainless steel 3Cr13.
- Handle made of stainless steel 430 with anti-slip rubber coating.
- Due to the highest quality of the workmanship, knives are durable and resistant to corrosion with long-lasting sharpness of the blade.
- With safe, profiled handle.
- Included:
 - 1 - Paring knife 193 mm
 - 2 - Boning knife 285 mm
 - 3 - Bread knife 333 mm
 - 4 - Carving knife 331 mm
 - 5 - Chef’s knife 330 mm
 - 6 - Chef’s knife 370 mm
 - 7 - Santoku knife 336 mm
 - 8 - Knife sharpener 340 mm
 - 9 - Carving fork curved 320 mm



Convenient carrying case

code	mm
975770	445x260x(H)65



TRUFFLE SLICER

- The perfect tool for slicing thin slices of truffle.
- Blade made of stainless steel (AISI 420) - 55HRC hardness.
- Blade housing made of stainless steel (AISI 430).
- Blade adjustment by screw.
- Slice thickness: from 0.2 to 3 mm.

code	mm
229835	220x85



229835





KNIVES HACCP

- Polypropylene handle in accordance with HACCP guidelines.
- Each knife is individually packed in a PET blister.



BROWN - COOKED MEAT

code			blade/knife length (mm)	thickness (mm)
842669	1	Cook's knife	180/320	2,5
842799	2	Cook's knife	240/385	2,5
842966	3	Ham/salmon knife with granton edge	350/490	1,7



RED - RAW MEAT

code			blade/knife length (mm)	thickness (mm)
842423	4	Carving knife	150/290	2,5
842522	5	Filleting knife	150/300	0,9
842621	6	Cook's knife	180/320	2,5
842720	7	Cook's knife	240/385	2,5
842928	8	Ham/salmon knife with granton edge	350/490	1,7



YELLOW - POULTRY

code			blade/knife length (mm)	thickness (mm)
842539	9	Filleting knife	150/300	0,9
842638	10	Cook's knife	180/320	2,5
842737	11	Cook's knife	240/385	2,5



BLUE - FISH

code			blade/knife length (mm)	thickness (mm)
842546	12	Filleting knife	150/300	0,9
842645	13	Cook's knife	180/320	2,5
842744	14	Cook's knife	240/385	2,5



**ERGONOMIC
NON SLIP
HANDLE**



WHITE - CHEESE & BREAD



code		blade/knife length (mm)	model	thickness (mm)
842256	15	Universal knife with granton edge	90/190 short model	1,2
842355	16	Universal knife with granton edge	130/230 long model	1,2
842553	17	Filleting knife	150/300	0,9
842652	18	Cook's knife	180/320	2,5
842751	19	Cook's knife	240/385	2,5
843055	20	Bread knife	250/385	1,5
843154	21	Bread knife	300/430	1,5

GREEN - FRUITS & VEGETABLES



code		blade/knife length (mm)	model	thickness (mm)
842218	22	Universal knife with granton edge	90/190 short model	1,2
842119	23	Universal knife	100/205 serrated	1,2
842317	24	Universal knife with granton edge	130/230 long model	1,2
842614	25	Cook's knife	180/320	2,5
842713	26	Cook's knife	240/385	2,5

PURPLE - ALLERGENS

code		blade/knife length (mm)	thickness (mm)
842270	27	Universal knife with granton edge	90/190 1,2
842171	28	Universal knife with granton edge	100/205 1,2
842478	29	Carving knife	130/280 2,5
842676	30	Cook's knife	180/320 2,5
842775	31	Cook's knife	240/385 2,5

PARING KNIVES, SET OF 6 COLOURS

- Polypropylene handle in accordance with HACCP guidelines.



842003

PARING KNIVES

- Set with 6 different colours: white, red, blue, green, black and yellow.
- Made of rolled steel.

code	blade length (mm)	length (mm)
842003	75	175



842010

PARING KNIVES

- Set with 6 different colours: white, red, blue, green, black and yellow.
- Made of rolled steel.

code	blade length (mm)	length (mm)
842010	90	185



841105

841112

841129

841136

PARING KNIVES AND PEELERS

- High quality



PARING KNIFE

code	-	blade length (mm)	mm
841105	straight model	75	(L)180
841112	pointed model	87	(L)190
841129	curved model	60	(L)165

TOMATO KNIFE

- Polypropylene handle.
- Made in Germany.



code	blade length (mm)	length (mm)
841136	110	215



841020

PARING KNIFE WITH WOODEN HANDLE

- Made in Germany.



code	blade length (mm)	length (mm)
841020	60	165



841228

SPEED PEELER

- Transverse model.



code	blade length (mm)	length (mm)
841228	50	110



841235

PEELER

- Pendulum model.



code	blade length (mm)	length (mm)
841235	50	150



856314

POULTRY SHEARS

- High carbon steel.
- Softgrip.

code	mm
856314	(L)240



856307

KITCHEN SCISSORS

- Detachable - easy to clean.
- Softgrip.

code	mm
856307	(L)200



Bottle opener integrated



856284

KITCHEN SCISSORS

- Detachable. With soft grip.
- Easy to clean

code	mm
856284	(L)225



556641

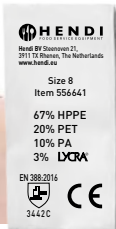

CUT RESISTANT GLOVES, CERTIFIED - SET OF 2 PCS.

- Offer protection during handling and replacing sharp blades in cutting equipment used in professional kitchen.
- The combination of HPPE, polyester and nylon fibres makes the gloves durable and comfortable.
- Level 4 cut resistance.
- Level 3 abrasion resistance.

code	packed per
556641	2



556665



CUT RESISTANT GLOVES, CERTIFIED

- Consists of 2 gloves, a HPPE inner glove and the chain mail outer glove.
- Outer glove made of stainless steel, durable, cut resistant and food contact approved.
- Soft and comfortable HPPE inner glove.
- Suitable for right and left hand use.

code		mm
556672	Large	(L)330
556665	Medium	(L)305



781913



OYSTER KNIFE ROUND

code	mm
781913	(L)170



781920



OYSTER KNIFE STRAIGHT

code	mm
781920	(L)160



844458



OYSTER KNIFE LONG

code	mm
844458	(L)215



Watch the video

224403



KNIFE SHARPENER

- Suitable for quick and easy sharpening of knives.
- Sand paper easy to change.

code	V	W	mm
224403	230	50	295x110x(H)110
224410	Sand paper for knife sharpener – Grit 320		50x200
229828	Sand paper for knife sharpener – Grit 1000		50x200



820605



KNIFE SHARPENER

- With finger protection.
- Reversible double sharpening blades made of carbide.

code	mm
820605	140x15x(H)65



820612

CERAMIC: crossed electroplated rods for ceramic knives

COARSE: carbide sharpener for a precision edge every time

FINE: crossed ceramic rods for professional grade edge honing



KNIFE SHARPENER

- Ergonomic handle and non-slip base provide safety and comfort.
- 3 functions for sharpening all kinds of knives, even ceramic knives.
- Do not use to sharpen serrated blades or scissors.

code	mm
820612	200x46x(H)75

JAPANESE SHARPENING STONE HENDI BY NANIWA

- The double-sided stone consists of 2 plates with 2 different grit sizes:
 - 220/1000 (820667).
 - 1000/3000 (820674).
- Stone grit - with its purpose:
 - 220: blade edge grinding and regeneration.
 - 1000: basic blade sharpening.
 - 3000: blade edge polishing and finishing.
- Before use wet the stone with water.
- The set includes a plastic box for safe storage.

code	mm
820667	185x65x(H)30
820674	185x65x(H)30

NEW



820667

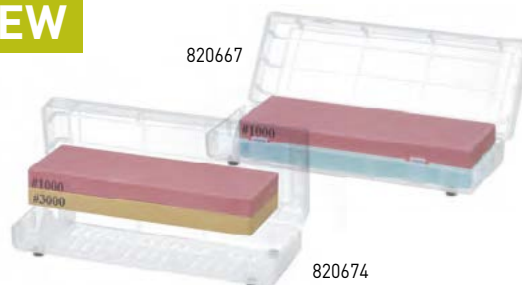

820674

NEW



GARLIC PRESS

- Made of stainless steel – durable and easy to clean.
- Its curved arch enables quick and effortless crushing.
- Crushing multiple garlic cloves at once is possible thanks to its size and many holes in its mesh.
- Useful also for other products than garlic, such as ginger.
- Hole diameter: \varnothing 3 mm

code	mm
856260	105x50



856260



690000

CAN OPENER KITCHEN LINE

- Including table mounting device.
- Suitable for cans up to 335 mm.

code	mm
690000	250x115x(H)550



570715



GARLIC PRESS

code	mm
570715	175x30



856123



GARLIC PRESS

- Easy to clean.
- Two removable grids.

code	mm
856123	180x25



CAN OPENER

code	mm
856116	(L)180



856116



SAFE CAN OPENER

- This safe can opener removes the lid without leaving sharp edges and provides the possibility to place the lid back on the can.
- The cutting mechanism operates by cutting the side of the can just below the lid.

code	mm
856161	(L)190



856161





Watch the video



LEMON ZESTER

code	mm
856031	(L)155



GRAPEFRUIT KNIFE

code	blade length (mm)	length (mm)
856185	100	210



VEGETABLE CORER

code	blade length (mm)	length (mm)
856086	110	220



CITRUS PEELER

code	mm
856055	(L)175



MELON SCOOP OVAL

code	ø	length (mm)
856017	ø26	(L)160



MELON SCOOP SERRATED

code	ø	length (mm)
856024	ø22	(L)150



MELON SCOOP DOUBLE

code	-	mm
856000	ø 22-25 mm	(L)165



CHANNEL KNIFE

code	mm
856048	(L)155



APPLE CORER

code	ø	length (mm)
856079	ø20	(L)215



DOUGH CUTTER SERRATED BLADE

code	ø	length (mm)
856154	ø60	(L)188



BUTTER CURLER - Serrated.

code	mm
856192	(L)190



SPREADER - SERRATED

code	blade length (mm)	length (mm)
855768	85	210



POTATO PEELER

code	blade length (mm)	length (mm)
856178	65	175



DECORATION KNIFE

code	blade length (mm)	length (mm)
856062	90	200



TOMATO KNIFE OFFSET

code	blade length (mm)	length (mm)
856253	110	224



CHEESE SLICER

code	mm
856208	(L)200



CHEESE SLICER FOR SOFT CHEESE

code	mm
856215	(L)160



CHEESE GRATER

code	mm
856222	(L)170



CHEESE KNIFE FOR HARD CHEESE

code	blade length (mm)	length (mm)
856239	130	250



CHEESE KNIFE FOR SOFT CHEESE

code	blade length (mm)	length (mm)
856246	160	270



PIZZA SLICER

code	ø	length (mm)
617007	ø100	(L)230



PIZZA SLICER

- Stainless steel knife blade, polypropylene handle.
- With HACCP color coding system, coloured clips are not removable after placing.

code	ø	length (mm)
617014	ø100	(L)230

844366



MINCING KNIFE

code	-	mm
844359	single blade	(L)215
844366	double blade	(L)215



844359

NEW



400081

CHEF PLATING SET, 6 PCS, SATINED

- Perfect for plating dishes, cakes and other desserts, as well as sushi.
- Made of satin stainless steel.
- Tweezers are perfect for gripping very delicate ingredients and optimised for effortless use.
- The drawing spoon with a spout for precise pouring of sauces.
- With compact roll-up case for protecting against damage.
- Straight tweezers: 23 cm
- Curved tweezers: 20 cm
- Offset tweezers (sushi): 21 cm
- Drawing spoon: 22,5 cm
- Small spoon: 15 cm
- Spatula: 19 cm
- Dishwasher safe.

code

400081

NEW



400074

CHEF PLATING SET, 6 PCS, BLACK

- Perfect for plating dishes, cakes and other desserts, as well as sushi.
- Made of stainless steel with black PVD coating.
- Tweezers are perfect for gripping very delicate ingredients and optimised for effortless use.
- The drawing spoon with a spout for precise pouring of sauces.
- With compact roll-up case for protecting against damage.
- Straight tweezers: 23 cm
- Curved tweezers: 20 cm
- Offset tweezers (sushi): 21 cm
- Drawing spoon: 22,5 cm
- Small spoon: 15 cm
- Spatula: 19 cm
- Not dishwasher safe.

code

400074

856291



DECORATION TOOLSET - 6 PCS.



- The set includes:
 - Fruit baller double-ended
 - Fruit coring knife ø20 mm
 - Decoration knife
 - Fruit baller serrated
 - Citrus zester
 - Channel knife

code

mm

856291

280x100x(H)50



6 knives
(max. length
400 mm)

856383

KNIVES CARRYING CASE

- Briefcase model for 6 knives (max. length 400 mm).
- Knives are held in place by elastic bands.
- Case reinforced with plastic for a solid construction.
- Dimensions open (LxW): 450x400 mm.
- Knives not included.

code	mm
856383	450x70x(H)110



17 knives
(max. length
450 mm)

856390

KNIVES CARRYING CASE

- Compact case with a total of 17 slots.
- Fits 4 knives with a maximum length of 450 mm and 13 smaller tools.
- Divider reinforced with plastic.
- Knives and tools are held in place by elastic bands.
- Dimensions unfolded: 500x510 mm.
- With shoulder strap.
- Knives not included.

code	mm
856390	500x120x(H)225



10 knives
(max. length 450 mm)

856277

KNIVES CARRYING CASE

- Compact case with plenty of room for knives and accessories.
- Space for 10 knives (max length 450 mm), knives are held in place by elastic.
- The knives are protected by additional covers which are held in place by either a zipper or velcro, this ensures that knives don't make direct contact when the case is folded to a close.
- With 1 big pocket for note pads, 4 small pockets for business cards and space for 3 pens or other small accessories.
- The shoulder strap length can be adjusted between 770 mm and 1270 mm.
- Dimensions unfolded: 515x675 mm.
- Knives not included.

code	mm
856277	510x50x(H)170



281246



UV STERILIZER

- Perfect for sterilizing knives, capacity for 14 knives.
- Made of stainless steel with plexiglass door.
- Fitted with stainless steel knife holder.
- Sterilizes by means of bactericidal ultraviolet light.
- Equipped with a microswitch to prevent operation while the door is open.
- Integrated timer adjustable up to 60 minutes.
- Accommodates the maximum size knives:
 - handle length - max 150 mm,
 - blade length - max 350 mm,
 - grip thickness - min 15 mm.

code	V	W	mm
281246	230	25	510x160x(H)610



Watch the video



680025

18/0
stainless steel

MULTIPURPOSE TWEEZERS

code	mm
680018	(L)300
680049	(L)160
680032	(L)215
680025	(L)230



680186

18/0
stainless steel

TWEEZER, CURVED, WITH PROFILED HANDLE

code	mm
680186	(L)240



680063

18/0
stainless steel

TWEEZERS CURVED

code	mm
680070	(L)160
680063	(L)240
680056	(L)300



680162

18/0
stainless steel

TWEEZER, SQUARE HEAD

code	mm
680162	(L)145



680087

OFFSET TWEEZERS

code	mm
680087	(L)210
680094	(L)160



680124

TWEEZER, ROUND HEAD

code	mm
680124	(L)150
680193	(L)305



18/0
stainless steel

680179

TWEEZER, CYLINDRICAL HEAD

code	mm
680179	(L)170



680131

18/0
stainless steel
wash

MULTIPURPOSE TWEEZER COATED

- With, by means of PVD applied, black coating.
- High quality and lasting.

code	mm
680131	(L)300



680216

18/0
stainless steel
wash

TWEEZERS, ROUND HEAD, COATED

- Made of 18/0 stainless steel.
- Black PVD coating.
- High quality and durability.

code	mm
680216	(L)305



680155

18/0
stainless steel

FISH BONE TWEEZER POINTED

code	mm
680155	(L)155

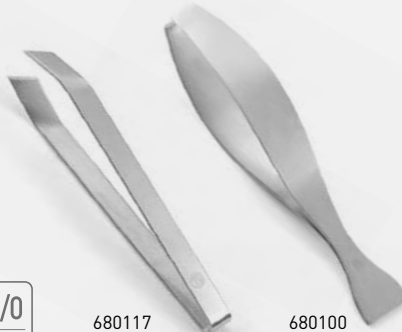

680117

680100

FISH BONE TWEEZERS, SLANTED HEAD

code	mm
680117	(L)115
680100	(L)135



680148

18/0
stainless steel

FISH BONE TWEEZER, SLANTED TIP

code	mm
680148	(L)100





PP 18/8
polypropylene stainless steel

Extremely sharp,
laser cut rasps



856352 856369 856376 856321 856338 856345

RASPS

- Laser cut blades, high precision and extremely sharp.

code	-	blade length (mm)	mm
856352	Fine	220	35x405
856369	Coarse	220	35x405
856376	Ribbon	220	35x410

RASPS

- Laser cut blades, high precision and extremely sharp.

code	-	blade length (mm)	mm
856321	Coarse	134	65x330
856338	Ribbon	135	65x330
856345	Shaver	134	65x330

S.S. stainless steel
wash



GRATER, FOUR-SIDED

code	mm
443002	90x65x(H)200

Al aluminium
wash



570104

EGG SLICER - RECTANGULAR

code	mm
570104	130x85x(H)30

Al aluminium
wash



570012

EGG SLICER - OVAL

code	mm
570012	120x115x(H)35

HENDI SAMURAI JAPANESE MANDOLINE

- Sturdy construction: elements made of stainless steel, ABS and polypropylene.
- Flat steel surface is divided into 2 parts which can be opened for easy access to blades, in order to adjust, remove or clean them. The surface has non-stick PTFE coating which facilitates very smooth cutting (vegetables/fruits slide smoothly).
- Ultra-sharp blades in a few variants offering various – but always perfectly precise and consistent – cutting effects:
 - 2 flat blades located on a reversed piece: smooth or serrated blade,
 - removable and rotatable roller with serrated blades; cutting thickness and type are easily adjustable with a knob: from 0 mm to 9 mm, slices or julienne.

code	mm
237922	395x165x(H)115

NEW



237922

VEGETABLE CUTTER V-TYPE

- Made of hard black PP and ABS.
- Including 5 high quality stainless steel blades.
- Foldable stand with rubber feet.
- V-shaped main cutting blade.
- Blades for julienne or french fries, 6 or 9 mm wide.
- Adjustable slice thickness from 1-9 mm.
- Product holder with metal pins.
- Height 140 mm (with raised support).

code	mm
222614	130x335x(H)75



V-shaped cutting blade for fast slicing

222614

VEGETABLE CUTTER V-TYPE DOUBLE BLADED

- Made of stainless steel and black ABS.
- V-shaped main slicing blade, crinkled secondary slicing blade.
- Easy to adjust the slicing thickness of both blades.
- Foldable stand with rubber feet.
- Comes with two extra blades for julienne or french fries, 6 or 9 mm wide.
- Storage box included to safely store the blades.
- Polypropylene product holder with metal pins.

code	mm
222676	530x165x(H)203



222676

VEGETABLE CUTTER

- 2 blades for slicing (1 crinkle blade) and 3 blades for julienne (5, 7, 10 mm).
- Sliding product holder and storage box for blades.
- With non-slip stand.

code	mm
222652	395x125x(H)200



Comes complete with product holder, 5 blades and blade storage box



222652



Fitted with hand protection



570159

With suction cup feet

TOMATO SLICER

- Only for cutting tomato or soft vegetables/fruits.
- Slice thickness \pm 5 mm.
- Easy to clean.
- With suction cup feet.
- Screw tightening tools such as Hex socket wrench not included.

code	mm
570159	432x202x(H)210

Special mounting plate allows easy removal and cleaning



With suction cup feet

FRENCH FRIES CUTTER

- Knives made of stainless steel.
- Comes with 4 blades: 6, 9 and 13 mm, as well as a knife for 8 parts.
- Mountable to working table or wall.
- Handle covered by plastic for easier pressing.
- Stainless steel mounting plate allows easy removal and cleaning.
- With rubber feet to hold firmly when using on table.



code	mm
630402	430x168x(H)290

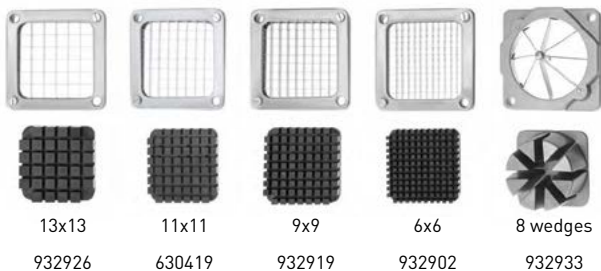

KNIFE FOR FRENCH FRIES CUTTER

- Fits HENDI French fries cutter 630402.
- Comes with pressing plate.



code	
932926	13x13
630419	11x11
932919	9x9
932902	6x6
932933	8 wedges

MEAT TENDERIZERS

MEAT TENDERIZING HAMMER

- Firm grip.
- Spiked surface for pork and beef.
- Plain surface for fish and poultry.



code	mm
513002	(L)260



MEAT TENDERIZER PROFI LINE

- Modern and effective tool for meat improvement, the interspaced vertical blades reduce the length of meat fibers.
- Perfectly tenderizes meat by softening the tissue and flattening meat at the same time.
- Marinating time can be reduced by up to 25%, because the surface area of the meat is significantly increased.
- During frying, the subtle perforation will allow sauces poured over the meat to penetrate.
- Soft springs, easier use, better result.



Watch the video



Specially designed grip

code	colour	mm
843451	Red	42x150x(H)118

51 stainless steel blades for cutting meat

Wave-shaped tabs on the bottom for flattening meat



For German steak



513538

BUTCHER'S HOOKS - A SET OF 4 HOOKS

code	mm
513538	90x4
513545	110x5
513552	130x5
513569	150x6



559239

ROULADE STRING RED & WHITE

- Soft and flexible, easy to bind and knot.
- Spool with 200g of string, about 132 meters.
- Made of red and white, unbleached cotton.

code	-
559239	132 m

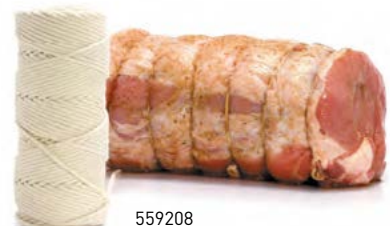

559208

ROULADE STRING

- Soft and flexible, easy to bind and knot.
- Spool with 100g of string, about 70 meters.
- Made of unbleached cotton.

code	-
559208	70 m
559222	140 m

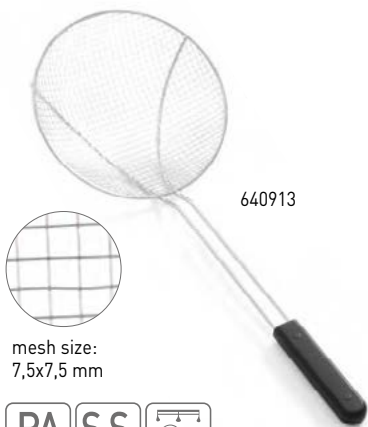

640913



mesh size:
7,5x7,5 mm



CHIP SCOOP

- Made of stainless steel with PA handle.
- With extra deep scoop.

code	mm
640913	ø240x640
640920	ø260x650

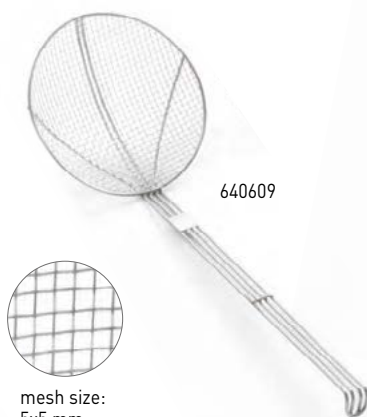

640609



mesh size:
5x5 mm



CHIP SCOOP

- With reinforced wire handle.

code	mm
640401	ø160x470
640500	ø180x470
640609	ø200x510
640708	ø220x540
640807	ø240x540

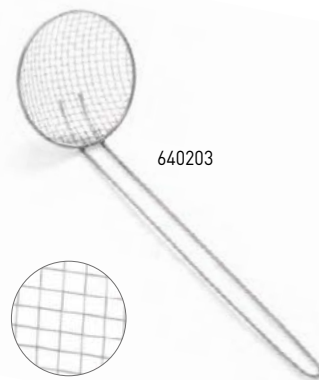

640203

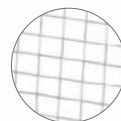

mesh size:
5x5 mm



CHIP SCOOP

- With wire handle.

code	mm
640104	ø100x310
640203	ø125x360

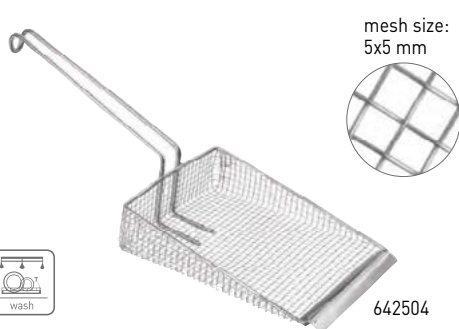

mesh size:
5x5 mm

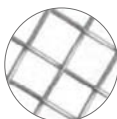

642504



CHIPS SHOVEL

- With 150 mm long wire handle.

code	mm
642504	470x180

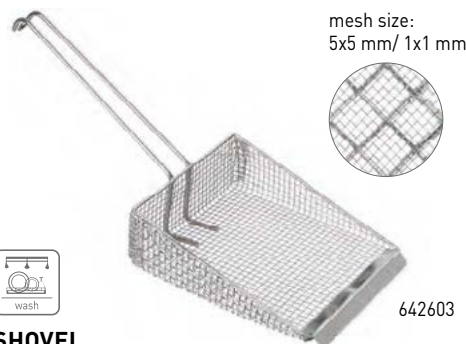

mesh size:
5x5 mm/ 1x1 mm

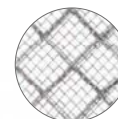

642603



CHIPS SHOVEL

- With 225 mm long wire handle.
- Double mesh.

code	mm
642603	335x175



646205

646304



FAT SKIMMER

- Made of stainless steel.
- With wire handle.
- Fine mesh.

code	mm
646205	ø125x350
646304	ø150x440



646601



BIRD'S NEST SHAPED STRAINER

- With wire handle and fastening clip.

code	mm
646601	ø100x390



642566



FRENCH FRIES AND NACHOS FUNNEL SCOOP

- Fill opening 70 mm.
- Left and right handed.

code	mm
642566	233x205



642559



FRENCH FRIES AND NACHOS FUNNEL SCOOP

- With detachable handles Fill opening 75 mm.
- Left and right handed.

code	mm
642559	230x220



630136

630235

SALT AND PEPPER SHAKER

- With screw cap.



code	-	mm
630235	Pepper shaker	ø63x(H)100
630136	Salt shaker	ø80x(H)175



630105

630204

SALT AND PEPPER SHAKER

- With screw cap.



code	-	mm
630204	Pepper shaker	ø65x(H)105
630105	Salt shaker	ø80x(H)195



630006



CHIPS COLANDER ALUMINIUM

- Fixed bottom and removable strainer.

code	mm
630006	ø400x(H)170



630808



CHIPS COLANDER STAINLESS STEEL

- Completely made of stainless steel.
- With stainless steel handle.
- With removable bottom tray.

code	mm
630808	ø410x(H)170



630808





516713



PROFI LINE LID FOR BUCKET WITH REINFORCED BASE

code	-	mm
516690	516683	ø280x(H)15
516713	516706	ø290x(H)15
516737	516720	ø305x(H)15

NEW



516768



BUCKET BUDGET LINE

- Made of stainless steel.
- The edge shape ensures easy control over the liquid during pouring.

code	liters	mm
516768	10	ø278x(H)235



Graduated



516683



516720

Wide, reinforced base for stability and hygiene

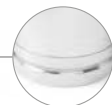

516744



BUCKET WITH REINFORCED BASE

- Graduated.

code	liters	mm
516676	7	ø230x(H)245
516683	10	ø280x(H)265
516706	12	ø300x(H)310
516720	15	ø305x(H)330

BUCKET

- Made of stainless steel
- Shape of the edge ensures easy control of the liquid while pouring

code	liters	mm
516744	12	ø310x(H)300



632802



GREASE FILTER FOR DEEP FRYER - 50 PCS

- Made of rayon (synthetic silk).

code	packed per	mm
632802	50	254x254



632901



GREASE FILTER HOLDER FOR DEEP FRYER

code	mm
632901	ø250x(H)240



BUCKET

- Suitable for storing frying oil and sauces
- Made of white polypropylene
- High heat resistance - can be filled with liquids at temperatures between 85-95°C
- Polypropylene lid (included)
- Side surface suitable for offset printing or labeling
- Useable volume: 11.3 l ± 120 ml
- Printable / labeling area: 810 x 155 mm
- Stackable (max load capacity of lower bucket: up to 45 kg)



196007

code	liters	mm
196007	11.5	ø300x(H)230



MEASURING JUG POLYPROPYLENE

- With gradation.

code	liters	mm
567104	0.5	ø90x(H)140
567203	1	ø110x(H)170
567302	2	ø140x(H)215
567401	3	ø160x(H)240
567500	5	ø190x(H)270



MEASURING JUG STACKABLE

- Scale embossed in the side of the jug.

- Shape of the handle allows multiple jugs to be stacked.

code	liters	mm
567814	0.5	ø95x(H)136
567821	1	ø124x(H)170
567838	2	ø160x(H)205
567845	3	ø181x(H)233
567852	5	ø210x(H)270



MEASURING JUG

- Top quality.

- Scale inside the jug.

code	liters	mm
516102	0.5	ø90x(H)105
516201	1	ø120x(H)130
516300	2	ø140x(H)170



ALUMINIUM SCOOP

code	liters	mm
521205	0.125	(L)180
521304	0.2	(L)205
521403	0.3	(L)245
521502	0.5	(L)265
521601	0.65	(L)310
521809	2	(L)390



POLYPROPYLENE SCOOP

code	liters	mm
562000	0.125	(L)187
562017	0.25	(L)250
562079	0.65	(L)330





462904

**NEW
MODEL**

OLIVE OIL DISPENSER

- Made of polished stainless steel.
- Conical shape ensuring stability.
- Removable stopper with a spout.

code	liters	mm
462904	0.25	ø84x(H)158



518700



FUNNEL WITH HANDLE

code	mm
518700	ø120x(H)115



567616



FUNNEL

code	mm
567616	ø100x(H)115
567630	ø127x(H)130
567654	ø150x(H)140



270875

NEW

PRESSURE FOOD SPRAYER

- Ideal for: greasing baking molds, applying food additives and flavourings, wetting bread dough.
- Spraying a perfectly even layer of a product.
- Pressure sprayer function in the kitchen without the need to use heavy appliances.
- Made of very durable polymer – HDPE.
- Wide bottom of the bottle, ensuring stability.
- Silicone seals which do not require greasing.
- An adjustable nozzle able to change its position in 360°.
- The suction pipe has a filter to prevent clogging.
- A measuring scale for easy control of liquid level.
- A breather protecting against the lid sucking-in.
- Pressure: 2,2 bar.
- Weight: 0,59 kg.

code
270875



222560

SALAD SPINNER

- Ideal for drying large amounts of vegetables and fruits after washing.
- With an easy to use water draining system.
- Removable inner basket.
- Not available in France.

code	liters	mm
222553	12	ø335x(H)430
222560	25	ø430x(H)530



ELECTRIC KETTLES

- Housing and heating element made of stainless steel.
- Handle, lid and base made of polypropylene.
- Concealed heating element protected against scale which extends the lifetime of the heater and the entire kettle.

- Indicator light informs that the heater is on.
- Internal maximum water level indicator.
- Automatic switch-off after boiling.
- Double dry-boil protection.



209981



Watch the video

External water level indicator



ELECTRIC KETTLE - 1,8 L

code	liters	V	W	mm
209981	1.8	230	2150	221x163x(H)249

209936



ELECTRIC KETTLE - 2,5 L

code	liters	V	W	mm
209936	2.5	230	2150	225x168x(H)288

CORDLESS ELECTRIC KETTLE WITH TEMPERATURE CONTROL

- For preparing beverages with indicated brewing conditions, such as green tea, white tea, or yerba mate.
- AISI304 stainless steel housing and heater.
- Polypropylene handle, lid, and base.
- Temperature regulation and maintenance – water can be heated to one of these temperatures: 40°C, 60°C, 80°C, 100°C.
- Heater placed under the bottom, protected against scale.
- Control panel with digital display.
- Thermostat indicator light.
- Internal maximum water level indicator.
- Automatic shut-off function after the water boiled.
- Double protection against switching on an empty kettle.
- Kettle can be rotated – 360° base.
- CAUTION: intended for boiling water only, boiling other liquids may damage the kettle.



code	liters	V	W	mm
209943	1.8	230	1800	225x168x(H)288

209943



Control panel with digital display



WATER KETTLE WITH LID

code	liters	mm
624302	6	ø245x(H)290



624302



SERVING TONGS - 2 PCS

code	packed per	mm
171127	2	(L)300
171028	2	(L)240



SERVING TONGS CURVED

code	mm
171417	(L)235
171516	(L)295



SERVING TONGS - 2 PCS

code	mm
171400	(L)240
171509	(L)300



SOLID DESIGN - THICKNESS 1 MM

SALAD TONGS
- With fastening clip.
- Solid design.



code	mm
171707	(L)240
171806	(L)310
171905	(L)400



SERVING TONGS
- With heat resistant silicone tongs.
- Soft-grip with lock.

code	mm
171301	(L)267
171318	(L)345
171325	(L)445



Watch the video



SERVING TONG HACCP 250 MM

- For professional food service - HACCP compliant handpiece colors
- Colored PVC Coated Handle

code	colour	mm
171837	Red	(L)250
171929	Brown	(L)250
171844	Blue	(L)250
171875	Green	(L)250
171882	Purple	(L)250
171899	Yellow	(L)250

SERVING TONGS HACCP 300 MM

- For professional food service - HACCP compliant handpiece colors
- Colored PVC Coated Handle

code	colour	mm
171721	Red	(L)300
171936	Brown	(L)300
171738	Blue	(L)300
171745	Green	(L)300
171783	Purple	(L)300
171790	Yellow	(L)300



SERVING TONGS

- Handle covered with PVC.

code	colour	mm
171752	Black	(L)250
171851	Black	(L)300



657607



657621



UNIVERSAL TONGS

code	colour	mm
657621	Transparent	(L)230
657607	Black	(L)230

657669



UNIVERSAL TONGS

code	colour	mm
657669	Black	(L)250
657676	Black	(L)300





524008

UNIVERSAL TONGS

- With fastening clip.
- Detachable.



code	mm
524008	(L)270



524039

UNIVERSAL TONGS WITH TEFLON COATING

- With fastening clip.



code	mm
524039	(L)270



171332

171349

SILICONE TONG FOR COOKING

- Made from high temperature resistant silicone.
- Can withstand temperatures up to 280°C making it ideal for use during cooking.
- The tongs provide plenty of grip and are comfortable to use.



code	mm
171332	(L)170
171349	(L)290



658000

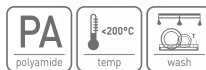

FRYING SPATULA

code	mm
658000	(L)280



NEW

525159



BENT WOODEN SPATULA - SET OF 2

- Made of beech wood - not only durable, but also lightweight.
- Resistant to high temperatures.
- Bent for easy flipping ingredients in a frying pan.
- Flat handle with a hanging hole.
- Suitable for pans with non-stick coating - not damaging their delicate surface.

code	packed per	mm
525159	2	(L)320

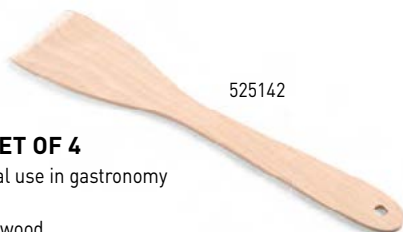

525142

WOODEN SPATULA - SET OF 4

- For professional use in gastronomy
- Versatile use
- Made of beech wood
- Flat handle with a hole

code	packed per	mm
525142	4	(L)300



659502



SPATULA

- Slotted.
- Made of reinforced polyamide.

code	mm
659502	(L)300



659601

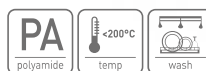

ANGLED FRYING SPATULA

code	mm
659601	(L)325



855713



SCRAPER

- Black plastic handle

code	blade length (mm)	mm
855713	124	102x265



855119



SCRAPER

- With wooden handle.

code	blade length (mm)	mm
855119	118	100x251



855607

855508

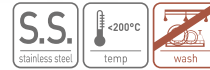

HAMBURGER TURNER

- With wooden handle

code	blade length (mm)	mm
855508	120	75x270
855607	150	110x305



855676

855652



HAMBURGER TURNER

- Handle made of black plastic.

code	blade length (mm)	mm
855676	143	77x283
855652	174	108x313



855669

855737



TURNER FLEXIBLE

- Handle made of black plastic.

- Flexible.

code	thickness (mm)	mm
855737	1	375x73
855669	1.2	320x96



855720



TURNER FLEXIBLE, PERFORATED

- Handle made of black plastic.

- Perforated.

- Flexible.

code	thickness (mm)	mm
855720	1	375x75



855775

855782

855683



PALETTE KNIFE

- With flexible offset blade.

code	blade length (mm)	mm
855775	110	19x220
855782	200	32x343
855683	254	37x390



855706

855690

855744



SPATULA

- For confectionery substances.

- Smooth flexible blade.

code	blade length (mm)	mm
855706	110	17x220
855690	203	34x345
855744	255	37x400



SCRAPER

- ABS handle.
- Silicone blade.

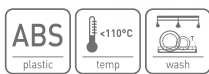

code	blade length (mm)	mm
659205	90	52x257
659304	116	70x358
659403	116	70x410

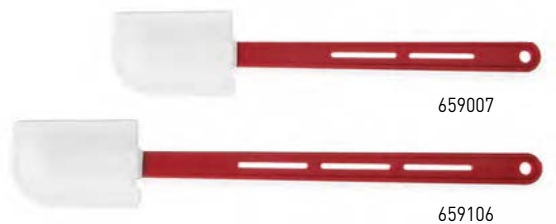

SCRAPER

- ABS handle.
- Silicone blade.



code	blade length (mm)	mm
659014	90	55x266
659007	105	70x354
659106	105	70x420



SCRAPER

- Handle made of glass-fiber reinforced nylon.
- Blade made of natural rubber.
- Only suitable for cold food preparation.



code	blade length (mm)	mm
658604	90	55x260
658703	90	75x320
658802	90	75x425
658901	150	100x515



SCRAPER SPOON SHAPED

- ABS handle.
- Blade made of synthetic rubber.

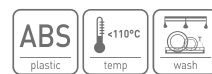

code	blade length (mm)	mm
659472	117	75x408
659458	88	57x254
659465	117	75x357

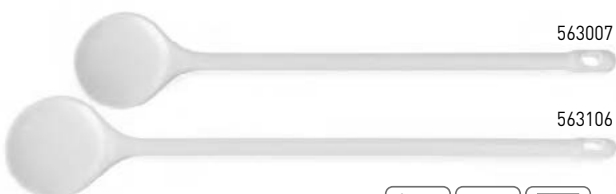

SPOON



code	mm
563106	450x80
563007	375x70
563205	575x105



SPOON

- Made of reinforced polyamide.



code	mm
659700	(L)305
659809	(L)385



WOODEN SPOON - SET OF 3, VARIOUS SIZES

- For professional use in gastronomy
- Versatile use
- Elegant, classic shape
- Made of beech wood
- Set of 3
- ATTENTION: Not dishwasher safe



code	mm
525005	(L)300, 350, 400

LADLES & SKIMMERS PROFI LINE

- Professional, seamless one piece, in accordance with HACCP standards.

- Heavy-duty stainless steel.
- Thickness 2,7 mm

2.7 MM
THICKNESS



LADLE NON-DRIP

- With non-drip pouring rim.

code	liters	mm
540107	0.05	ø60x360
540305	0.125	ø80x400
540404	0.25	ø100x430
540503	0.5	ø120x555
540602	0.75	ø145x575
540701	1	ø165x630

SLOTTED SPOON

code	mm
541104	ø80x390
541203	ø100x400
541302	ø120x460
541500	ø160x530

SERVING SPOON

code	mm
542507	485x75

CARVING FORK

code	mm
542705	(L)350

BASTING SPOON

code	mm
542606	410x100

SPATULA

code	mm
542200	510x100

LADLES & SKIMMERS KITCHEN LINE

1.5 MM
THICKNESS



LADLE

code	liters	mm
527108	0.05	ø60x320
527207	0.18	ø90x390
527306	0.21	ø100x420

SKIMMER

code	mm
528105	ø90x310
528204	ø115x370

SLOTTED SPATULA

code	mm
526118	(L)355

SPATULA

code	mm
526101	(L)350

CARVING FORK

code	mm
526200	350x35

VEGETABLE SPOON

code	mm
526309	(L)325

WHISKS

509470

1 MM
THICKNESS



2.2 MM
THICKNESS



2 MM
THICKNESS

FRENCH WHISK

- 8 heavy stiff wires, with eyelet.
- Wire thickness: 2,2 mm.

code	mm
510001	(L)290
510100	(L)335
510209	(L)380
510308	(L)435
510407	(L)490
511503	(L)540
511701	(L)640

FRENCH WHISK WITH 8 STIFF WIRES

- 8 stiff wires.
- Polypropylene handle with eyelet.
- Wire thickness: 2 mm.

code	mm
509012	(L)245
509005	(L)270
509104	(L)320
509203	(L)365
509302	(L)415
509401	(L)465

PIANO WHISK

- 5 flexible piano wires, with thin handle.
- Wire thickness: 1 mm.

code mm
509470 (L)285



509487



SPIRAALGARDE

code mm
509487 (L)280



856109

DRESSING- AND PANWHISK

code mm
856109 (L)300



510100

510209

510308

509012

509203

509302



Hard wires



Hard wires



530702



530108



530405



KITCHEN BOWL

code	liters	mm
530108	0.7	ø160x(H)63
530207	1.2	ø205x(H)74
530306	1.5	ø227x(H)83
530405	2.6	ø254x(H)95
530504	3.3	ø281x(H)100
530603	4.4	ø310x(H)107
530702	5.7	ø340x(H)113



1.4 MM

THICKNESS

PIANO WHISK

- 7 flexible piano wires, with eyelet.
- Wire thickness: 1,4 mm.

code	mm
532003	(L)230
532102	(L)275
532201	(L)330
532300	(L)375



1.4 MM

THICKNESS

PIANO WHISK

- 12 flexible piano wires.
- Stainless steel handle with eyelet.

code	mm
511718	(L)285
511725	(L)335
511732	(L)385
511749	(L)435
511756	(L)485



1.4 MM

THICKNESS

PIANO WHISK WITH 12 PIANO WIRES

- 12 flexible piano wires.
- Polypropylene handle with eyelet.
- Piano wire thickness: 1.4 mm.

code	mm
509418	(L)250
509425	(L)270
509432	(L)320
509449	(L)360
509456	(L)410
509463	(L)460



Extremely flexible wires perfect for whipping



Extremely flexible wires perfect for whipping



Extremely flexible wires perfect for whipping



MIXING BOWL

code	liters	mm
517109	0.7	ø158x(H)55
517208	1.4	ø197x(H)68
517307	2.3	ø240x(H)88
517406	3.3	ø259x(H)92
517604	4.9	ø300x(H)118



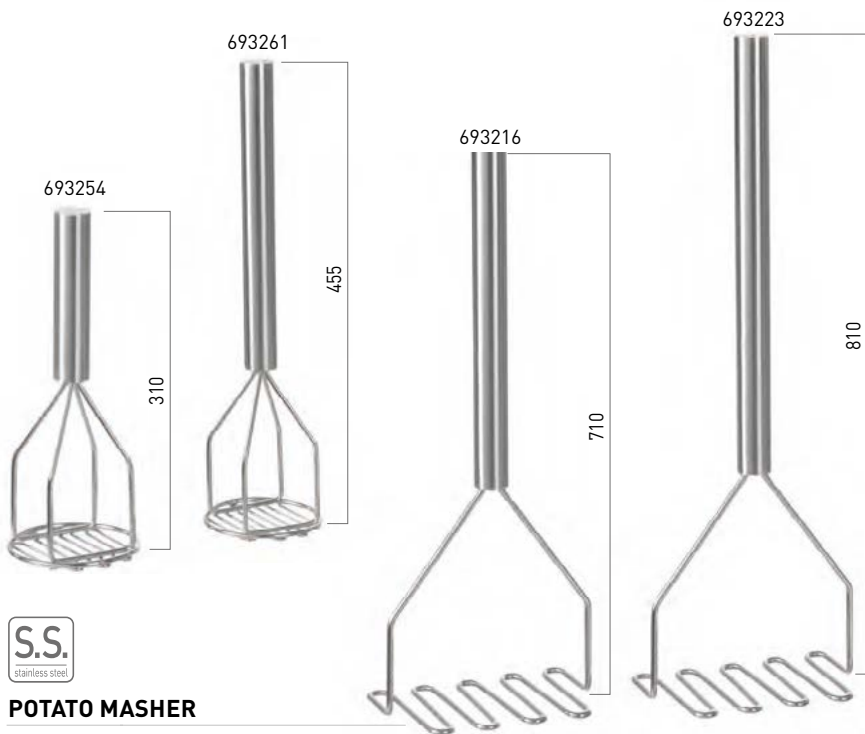

POTATO MASHER

code	mm
693254	ø118x(H)310
693261	ø118x(H)455



POTATO MASHER

code	mm
693216	200x130x(H)610
693223	200x130x(H)810



POTATO MASHER

- Comfortable handle made of polypropylene.

code	mm
856147	ø95x(H)230



856147



693209

770

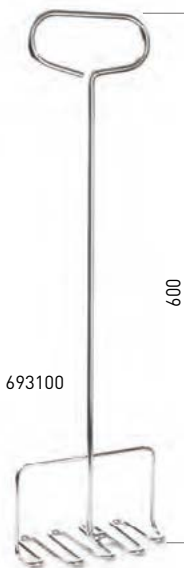

693100

600



693001

355



515105



POTATO RICER

code	mm
515105	320x110



POTATO MASHER

code	mm
693001	130x85x(H)355
693100	180x85x(H)600
693209	180x85x(H)770



647509

647516

mesh size
0,5x0,5 mm



CONICAL STRAINER, WIRE MESH
- Fine mesh.

code	mm
647516	ø160x360
647509	ø180x415



647561

647554

mesh size
0,5x0,5 mm



CONICAL STRAINER WITH WIRE MESH
- Fine mesh.

code	mm
647554	ø205x460
647561	ø245x500



547502

547304

mesh size:
ø2 mm



CONICAL STRAINER

code	mm
547304	ø180x380
547502	ø235x435



556719

CLOTH STRAINER
- 100% Cotton.
- Washable up to 95°C.

code	mm
556719	700x700



NEW



567555

CONICAL STRAINER WITH WIRE MESH, REINFORCED

- Entirely made of AISI 201 satined stainless steel.
- Very fine mesh, reinforced.
- Flat handle with a hole, reinforced.
- Fitted with an additional supporting handle.
- Everted rim.
- Dishwasher safe.

code	mm
567555	505x250x(H)200



515501



Fitted with
2 scraping wires
on the bottom



VEGETABLE STRAINER

- Perfect for preparation of cream soups and tomato sauces.
- Including 2 straining discs (Ø 140 mm), coarse and fine.

code	mm
515501	400x215x(H)175



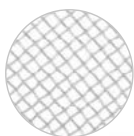

mesh size
1x1 mm

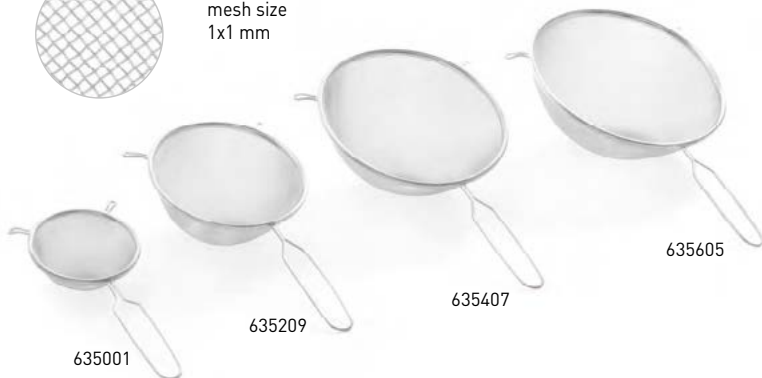

SIEVE

- With wire handle.

code	mm
635001	ø120x290
635155	ø160x340
635209	ø180x355
635308	ø200x365
635407	ø230x395
635605	ø250x420

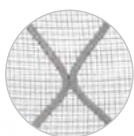

mesh size
4x4 mm/1,5x1,5 mm



SIEVE, DOUBLE MESH

- Wooden handle.

- Reinforcing bracket.

code	mm
639009	ø260x580
639016	ø310x800
639023	ø360x850



mesh size
0,5x0,5 mm



SIEVE

- With wire handle.

code	mm
638309	ø100x255
638507	ø145x340
638705	ø210x450
638903	ø230x455

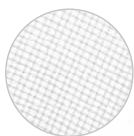

mesh size
1x1 mm

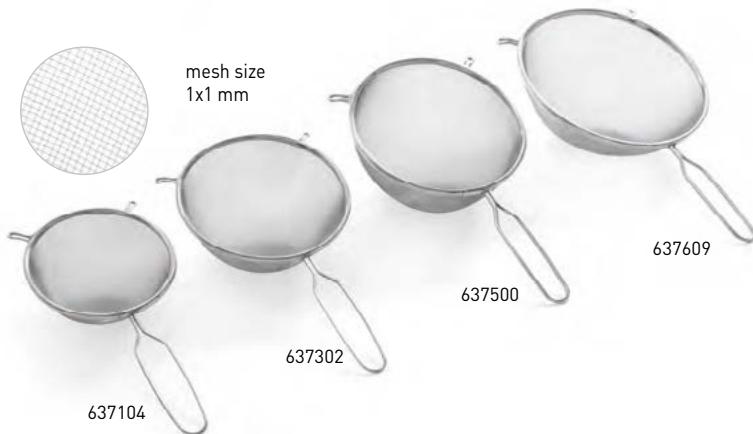

SIEVE

- With wire handle.

code	mm
637104	ø160x325
637203	ø185x350
637302	ø200x365
637401	ø220x385
637500	ø240x405
637609	ø260x425

COLANDERS



COLANDER PROFI LINE

- With base and 2 riveted handles.

code	mm
535523	ø415x(H)210
535516	ø365x(H)185
535509	ø325x(H)175



535516



535301

535202

535103



535424

535417

535400

COLANDER KITCHEN LINE

- With base and 2 handles.



code	mm
535301	ø340x(H)160
535103	ø240x(H)110
535202	ø280x(H)135

COLANDER

- 2 handles and a base.



code	mm
535400	ø225x(H)90
535417	ø285x(H)100
535424	ø315x(H)120



535219

EXTENDABLE SINK COLANDER

- Entirely made of stainless steel AISI 201.
- Extendable handles, non-slip - covered with rubber.
- Support-legs to place it directly in the sink.
- Fine mesh.
- Adjustable to max. sink width: 545 mm.
- Dishwasher safe.

code	mm
535219	360x240x(H)115

NEW



SCALES



NEW MODEL



580011



KITCHEN SCALE 3 KG

- Housing made of ABS and stainless steel.
- Built-in LED display.
- Measuring up to 3000 g.
- Readout in grams (g), kilograms (kg), millilitres (ml), ounces (oz) or pounds (lb).
- Available functions on the touchscreen panel: on/off, tare, changing the unit.
- Auto power off and reset (auto tara).
- Overload and low battery notifications.
- Power: 3 x 1.5V AAA batteries – included in the set.

code	mm
580011	165x180x(H)31



NEW MODEL



580226



KITCHEN SCALE 5 KG

- Housing made of stainless steel.
- Built-in digital LCD display.
- Measuring up to 5000 g.
- Readout in grams (g), kilograms (kg), ounces (oz) or pounds (lb).
- Auto power off and reset (auto tara).
- Overload and low battery notifications.
- Power: 1 x 3V lithium battery – included in the set.

code	max. kg	mm
580226	5	169x218x(H)13



NEW MODEL



580028



KITCHEN SCALE 10 KG

- Waterproof housing made of ABS and stainless steel.
- Built-in LED display.
- Measuring up to 10 000 g.
- Readout in grams (g), kilograms (kg), millilitres (ml), ounces (oz) or pounds (lb).
- Available functions on the touchscreen panel: on/off, tare, changing the unit.
- Auto power off and reset (auto tara).
- Overload and low battery notifications.
- Power: built-in rechargeable lithium battery.
- USB cable for recharging included in the set.
- Waterproof and dustproof rate: IP67.

code	mm
580028	160x210x(H)19

18/8
stainless steel

KITCHEN SCALE 15 KG

- Weighs up to 15.000g with gradation of 1g with a minimum of 2g.
- Seamless stainless steel surface, housing made of HIPS plastic with integrated display.
- High precision strain gauge sensor for accurate measurements.
- Readout in grams.
- Touch control with on-off and tare buttons.
- With auto tare, overload and low power indication.
- Auto power off.
- Powered by 3 AAA batteries (not included).

code	max. kg	mm
580233	15	266x269x(H)34



580233

NEW

max
200 kg



580462

S.S.
stainless steel

DIGITAL SCALE UP TO 200 KG

- Stainless steel scale.
- Precise measurement thanks to advanced technology - from 200 g to 200 kg (440 lb).
- Accuracy: 10-50g / 0,02-0,1lb.
- Reading in kg or lb.
- Tare function.
- Operation via separate digital display with 4 buttons.
- Energy-saving LCD display with battery charge indicator.
- Fingerprint-resistant coating.
- Power supply: 2 AAA batteries (included).
- USB-C port - kit includes cable.
- NOTE: Power adapter not included.

code	max. kg	mm
580462	200	298x248x(H)37



Thermometers



	Infrared thermometer	Shock proof thermometer	Shock proof thermometer with probe	Fast response thermometer
Code	271148	271254	271407	271230
Unit	°C / °F	°C / °F	°C / °F	°C / °F
Reaction time	quick	quick	medium	quick
Temperature min.	-32°C	-60°C	-50°C	-50°C
Temperature max.	400°C	350°C	300°C	350°C
Accuracy	±1,5°C	±1,5°C	±1°C	±0,8°C
Gradation	0,1°C	0,2°C	0,1°C	0,1°C
Hold function	✓	✓	✓	✓
Probe length		96 mm	213 mm	130 mm
Probe material		stainless steel	stainless steel	stainless steel
Suitable for use in the oven				
Waterproof			splash proof	✓
Auto off	✓	✓	✓	✓
Battery included	✓	✓	✓	✓
Additional information	Distance and spot size ratio 12:1 Laser pointer for accurate measurement target.	Distance and spot size ratio 8:1	Min / Max temperature function. With table stand, including protection case.	IP65 waterproof. With probe cover.





Thermometer with foldable probe

Pocket thermometer with probe

Waterproof thermometer

Roasting thermometer/timer

271308

271209

271162

271346

°C / °F

°C / °F

°C / °F

°C / °F

medium

medium

medium

slowly

-50°C

-40°C

-50°C

-50°C

300°C

200°C

300°C

250°C

±1°C

±1°C

±1°C

±1°C

0,1°C

0,1°C

0,1°C

1°C

✓

✓

✓

✓

110 mm

65 mm

120 mm

150 mm

stainless steel

stainless steel

stainless steel

stainless steel

only probe

✓

✓

✓

✓

✓

✓

✓

✓

Min / Max temperature function.

With probe cover.

Measures temperature in one second. With cover and ergonomic handle.

With timer function. With temperature alert setting.



Pocket thermometer

Steak thermometer

Oven thermometer

Refrigerator thermometer

Refrigerator thermometer

Refrigerator thermometer

Refrigerator thermometer

Milk frothing thermometer

	Pocket thermometer	Steak thermometer	Oven thermometer	Refrigerator thermometer	Refrigerator thermometer	Refrigerator thermometer	Refrigerator thermometer	Milk frothing thermometer
Code	271216	271339	271179	271186	271117	271124	271261	271247
Unit	°C	°C / °F	°C	°C	°C	°C	°C	°C
Reaction time	medium	slowly	slowly	slowly	slowly	slowly	slowly	slowly
Temperature min.	0°C		50°C	-50°C	-40°C	-50°C	-40°C	-10°C
Temperature max.	100°C		300°C	25°C	40°C	50°C	20°C	110°C
Gradation	1°C		10°C	10°C	1°C	1°C	1°C	1°C
Probe length	127 mm	50 mm						140 mm
Probe material	stainless steel	stainless steel						stainless steel
Suitable for use in the furnace		✓	✓					
Additional information	Probe cover with clip	With indication rare-medium-well done.	With special hook and support. Easy to read.	With special hook and support. Easy to read.	Fitted with hook to hang from	Fitted with hook to hang from	Horizontal model, with hooks	With clip to fasten the thermometer to the milk jug



271148

INFRARED THERMOMETER

- Laser pointer for accurate targeting.
- Measuring range: -32 to +400°C.
- Gradation: 0.1°C, accuracy: up to ± 1.5°C/ ± 1.5%.
- The ratio of the measuring distance to the area to be measured: 12:1.
- "Lock mode" function for continuous temperature monitoring.
- Automatic switch off.
- Power supply: 9 V battery, included in the set.



271254

INFRARED THERMOMETER WITH PROBE HACCP

- Temperature scan by infrared or foldable probe.
- HACCP check lights provide instant recognition of safe/unsafe temperatures.
- With foldable 90 mm long stainless steel probe.
- Measuring range -60°C to 350°C.
- Gradation 0,2°C.
- Infrared accuracy: -60/65°C ±1°C, 65/350°C ±1.5%.
- Probe accuracy: -60/-5°C ±1°C, -5/65°C ±0.5°C, 65/350°C ±1%.
- Distance spot ratio (D:S) 8:1.
- Auto power off after 15 seconds.
- Battery: 2xAAA (excluded).



271407

SHOCK PROOF THERMOMETER WITH PROBE

- Splash proof.
- Temperature range -50°C to 300°C.
- Unit of measurement °C or °F.
- Gradation 0,1°, accuracy 1°C between -30°C and 150°C.
- Lock mode for continuous monitoring of temperatures.
- Min/max temperature function.
- 213 mm removable stainless steel probe.
- Turns off automatically.
- With table stand, including protection case.
- Battery included.

code	range	mm
271148	-32/400°C	37x70x(H)150

code	range	mm
271254	-60/350°C	39x53x(H)158

code	range	mm
271407	-50/300°C	195x85x(H)45



271230



Provides fast and accurate temperature reading



271308

FAST RESPONSE THERMOMETER

- Provides fast and accurate temperature readings.
- IP65 waterproof.
- Measuring range -50°C to 350°C, unit of measurement °C or °F.
- Gradation 0,1°C, accuracy ±0,8%/0,8°C.
- Hold function - saves momentary temperature.
- 130 mm stainless steel probe.
- Turns off automatically.
- With probe cover.
- Battery included.

code	range	mm
271230	-50/350°C	204x42x(H)20

THERMOMETER WITH FOLDABLE PROBE

- Temperature range from -50° to 300°C.
- Unit of measurement °C or °F.
- Gradation 0,1°C, accuracy 1°C between 0° and 100°C.
- Lock mode - for continuous monitoring of temperatures.
- Min/max temperature function.
- With foldable 110 mm long stainless steel probe.
- Turns off automatically after 60 minutes.
- Battery included.

code	range	mm
271308	-50/300°C	160x40x(H)25

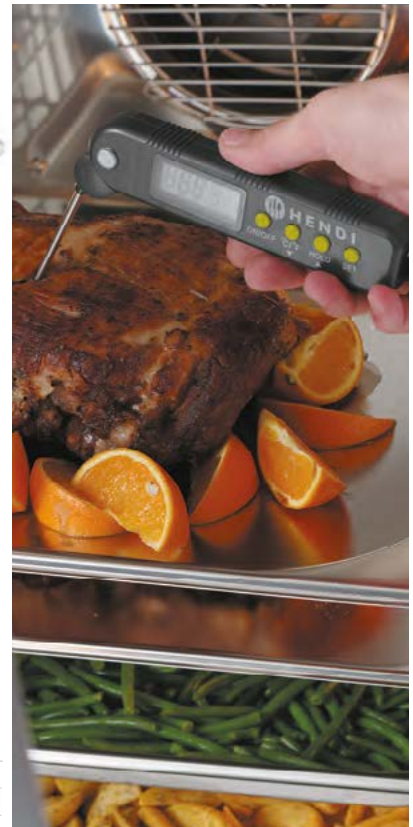



271209

POCKET THERMOMETER WITH PROBE

- Temperature range -40°C to 200°C.
- Unit of measurement °C or °F.
- Gradation 1°C.
- Accuracy ± 2°C.
- Hold function - saves momentary temperature.
- 65 mm stainless steel probe.
- Turns off automatically.
- With probe cover.
- Battery included.

code	range	mm
271209	-40/200°C	150x20x(H)15



271162

WATERPROOF THERMOMETER

- Waterproof.
- Temperature range -50°C to 300°C.
- Gradation 0,1°C between -19,9°C and 199,9°C, for other temperature ranges 1°C.
- Accuracy 1°C between -20°C and 100°C, for other temperature ranges ± 2°C.
- Lock mode - for continuous monitoring of temperatures.
- 120 mm stainless steel probe.
- Measures temperature in one second.
- With cover and ergonomic handle.
- Turns off automatically after 10 minutes.
- Battery included.

code	range	mm
271162	-50/300°C	290x48x(H)40



271346

ROASTING THERMOMETER WITH TIMER

- Timer function with countdown.
- Measuring range: from -50 to +250°C.
- Interchangeable between: °C and °F.
- 1°C gradation, accuracy ± 1°C from 0°C to +100°C, ± 2°C in other ranges.
- Possibility of continuous temperature monitoring.
- Max./min. temperature function.
- With acoustic signal informing about reaching the set temperature.
- Stainless steel probe 150 mm (heat resistant), can be left in the oven during baking.
- 1 AAA 1.5 V alkaline battery included (disposable).

code	range	mm
271346	-50/250°C	65x70x(H)17



271216

POCKET THERMOMETER

- Temperature range: from 0°C to 100°C.
- Gradation 1°C.
- 127 mm stainless steel probe.
- Probe cover with clip.
- Easy to read.

code	range	mm
271216	0/100°C	ø44,5x(H)140



271179

OVEN THERMOMETER

- Measuring range: from +50 to +300°C.
- 10 °C gradation, accuracy: ±5%.
- Stainless steel housing.
- Equipped with special hook and support.
- Easy to read.

code	range	mm
271179	50/300°C	60x40x(H)70



271339

STEAK THERMOMETER - SET OF 4 PCS.

- The range is: rare - medium - well done.
- Accuracy: ±2%.
- Stainless steel 50 mm probe.
- Can be used in ovens.

code	packed per	mm
271339	4	ø25x(H)70





271186

REFRIGERATOR THERMOMETER

- Temperature range from -50°C to +25°C.
- Gradation 2,5°C.
- Stainless steel housing with special hook and support.
- Easy to read.

code	range	mm
271186	-50/25°C	60x40x(H)70



271117

REFRIGERATOR THERMOMETER

- With hook.
- Temperature range -40 to 40 °C.
- Graduation 1°C.

code	range	mm
271117	-40/40°C	150x23x(H)9



271124

REFRIGERATOR THERMOMETER

- With hook.
- Temperature range -50 °C to 50 °C.
- Gradation 1°C.
- Easy to read.

code	range	mm
271124	-50/50°C	ø72x(H)21



271261

REFRIGERATOR THERMOMETER

- Horizontal model, with hooks.
- Temperature range -40 to 20 °C.
- Graduation 1°C.

code	range	mm
271261	-40/20°C	123x30x(H)19



271247

MILK FROTHING THERMOMETER

- With a clip to fasten the thermometer to the milk jug.
- Green marking indicates the perfect milk temperature for cappuccino etc.
- Temperature adjustable from -10°C to 110°C.
- 1°C gradation, accuracy: ±2% .
- Stainless steel probe, cover with clip.
- Easy to read.

code	range	mm
271247	-10/110°C	ø44x(H)140



271155



With clip



582022

DIGITAL KITCHEN TIMER

- With stand and magnet.
- 99 min. 59 s. count down.

code	mm
582022	65x70x(H)17



582015

ANALOG KITCHEN TIMER

- Max. 60 minutes.
- Accurate to 1 minute.
- Magnetic rear.
- Red marking indicates remaining time.
- Well visible from a distance.

code	mm
582015	ø80x(H)30



Magnetic

DIGITAL KITCHEN TIMER

- With magnetic clip.
- 99 min 59s count down.
- 1 X 1.5V AAA Alkaline Battery included (non-rechargeable).

code	mm
271155	67x20x(H)67



NEW

558102

STAINLESS STEEL SAUCE CONTAINER WITH DISPENSER

- Housing, spring in the dispenser and mechanical system made of AISI 304 stainless steel.
- The lower element of the dispenser made of polypropylene.
- Removable: lid, dispenser pump.
- Lid fitted with 2 snap latch locks.
- Dispensed sauce portion: 35 ml
- Not dishwasher safe.

code	liters	mm
558102	4.5	(H)420

NEW

558119

SET: 2 X STAINLESS STEEL SAUCE CONTAINER WITH DISPENSER

- Housing, spring in the dispenser and mechanical system made of AISI 304 stainless steel.
- The lower element of the dispenser made of polypropylene.
- Removable: lid, dispenser pump.
- Each lid fitted with 2 snap latch locks.
- Dispensed sauce portion: 35 ml
- Not dishwasher safe.
- Stand with adapter included in set.

code	liters	mm
558119	9	400x200x(H)440

NEW
PC 18/8
 polycarbonate stainless steel

558140

LID WITH DISPENSER FOR GN CONTAINERS

- Housing, spring in the dispenser and mechanical system made of AISI 304 stainless steel.
- The lower element of the dispenser made of polypropylene.
- Removable: lid, dispenser pump.
- Dispensed sauce portion: 35 ml.
- Not dishwasher safe.
- Suitable for GN containers with a height of 200 mm (not included).

code	GN	mm
558133	GN 1/6	180x165
558140	GN 1/4	270x165
558157	GN 1/3	330x180

NEW**SAUCE BAIN-MARIE WITH DISPENSER**

- Housing, spring in the dispenser and mechanical system made of AISI 304 stainless steel.
- The lower element of the dispenser made of polypropylene.
- Removable: lid, dispenser pump.
- Lid fitted with 2 snap latch locks.
- With overheating protection sensor - it turns on the sound alarm and automatically cuts the heating off.
- Adjustable heating temperature: up to 90°C.
- Dispensed sauce portion: 35 ml.
- Not dishwasher safe.

code	V	W	mm
558126	230	900	ø180x(H)500



<90 °C

558126

DISPENSER BOTTLES

- Made of polyethylene.
- The cap ensures that the sauce stays fresh and hygiene is maintained.



557990



558003 558010 558027 557808 557815 557822



NEW

MINI SAUCE DISPENSER - SET OF 4 PCS.

- Made of half-transparent polyethylene.
- Screw cap with a stopper.
- Reusable product.
- Dishwasher safe.
- 2 capacities available: 30 ml (code: 557981), 50 ml (code: 557990).

code	liters	mm
557990	0.05	ø35x(H)100
557891	0.03	ø30x(H)85

DISPENSER BOTTLES

code	packed per	colour	liters	mm
558003	1	Yellow	0.2	ø50x(H)185
558010	1	Red	0.2	ø50x(H)185
558027	1	Transparent	0.2	ø50x(H)185
557808	1	Yellow	0.35	ø55x(H)205
557815	1	Red	0.35	ø55x(H)205
557822	1	Transparent	0.35	ø55x(H)205
557907	1	Yellow	0.7	ø70x(H)240
557914	1	Red	0.7	ø70x(H)240
557921	1	Transparent	0.7	ø70x(H)240
558058	3	Transparent	0.2	ø50x(H)185
557853	3	Transparent	0.35	ø55x(H)205
557952	3	Transparent	0.7	ø70x(H)240



203521

203538

203545



SAUCE DISPENSER WITH PUMP

- Pump dispenser for various types of sauces.
- For use in snack bars, buffets, restaurants, and during catering events.
- ABS housing, removable sauce container completely BPA-free – does not affect the taste and smell of its contents.
- Sauce container has a measuring scale, lid and removable pump, all made from polypropylene.
- Pump fitted with lock to prevent accidental dispensing during transport.
- Capacity: 2.5 l.
- Dosage: 20 ml.
- Temperature resistance from -40°C up to +70°C.
- Easy to disassemble and stackable.
- Available in red, yellow and white.

code	colour	liters	mm
203521	Red	2.5	230x210x(H)250
203545	White	2.5	230x210x(H)250
203538	Yellow	2.5	230x210x(H)250



design by
Robert Bronwasser



558096

NON-DRIP SAUCES DISPENSER

- Designed by Robert Bronwasser.
- Clear bottle with specially designed dosing cap.
- Thanks to the construction of this piece of equipment, the bottle can be placed upside down without the risk of sauce spillage.

code	liters	mm
558096	0.23	ø50x(H)160



Non-drip tip



630648

HOTDOG STAND

- Quality finish.
- 2 dispenser bottle slots and 2 hotdog slots.
- Suitable for HENDI Dispenser bottles 70 cl.

code	mm
630648	260x110x(H)118



557976

SAUCE STAND

- Quality finish.
- Suitable for HENDI dispenser bottles.
- Available with 3 and 5 slots.

code	-	mm
557969	3 holes ø 50 mm	209x80x(H)78
557976	3 holes ø57 mm	229x90x(H)78
557983	3 holes ø70 mm	274x102x(H)98



429457

429440

TACO HOLDER

code	-	mm
429440	2 slots	135x115x(H)50
429457	4 slots	225x115x(H)50





551813

With three different nozzles (4, 5 and 6 mm)



18/8
stainless steel



CONFECTIONERY FUNNEL KITCHEN LINE

- With ergonomic handle, design of stop valve ensures a tight seal.
- With three different nozzles (Ø 4, 5 and 6 mm).
- Designed for dosing sauces of various consistency and decorating of dishes and confectionery.
- With wire stand.

code	liters	mm
551813	1.5	270x195x(H)270



Ergonomic polypropylene handle



Watch the video

551806

With three different nozzles (2, 4 and 6 mm)



ABS plastic S.S. stainless steel

CONFECTIONERY FUNNEL PROFI LINE

- Ergonomic handle made of ABS.
- Design of stop valve ensures a tight seal.
- With three different nozzles (Ø 4, 5 and 6 mm).
- Wire stand and dripping dish.
- Designed for dosing sauces of various consistencies and decorating of dishes and confectionery.

code	liters	mm
551806	1.5	ø212x(H)315





199992

SMOKE INFUSER

- The aluminium body functions as a heat sink, cooling the smoke before expelling it.
- Wood requires no pre-soaking prior to smoking.
- Can also be used with tea or spices.
- Removable smoking chamber with removable filter.
- Large woodchip holder.
- Flexible rubber hose (30 cm long) for easy injection of smoke into resealable bags and containers.
- Compact and lightweight enough to use with one hand.
- Gentle enough for use on delicate fruits and vegetables without changing their texture or temperature.
- Powered by 2 AA batteries, not included.
- Wood or herbs for smoking not included.

code	mm
199992	90x54x(H)122



199640

SMOKING GUN RECHARGEABLE – 3 SPEEDS OF SMOKE INFUSION

- Smoking is a very flavourful addition to your meat, fish and vegetable dishes, but can also create a wow-factor when serving.
- The cold smoke is gentle for delicate fruits and vegetables, smoke without changing the texture or temperature.
- One button operation, the smoking gun has 3 speeds
- The aluminium fan chamber functions as a heat sink, cooling the smoke before expelling it.
- Wood requires no pre-soaking prior to smoking.
- Can also be used with tea or spices.
- Removable smoking chamber with integrated mesh filter.
- Flexible silicone hose (50 cm long) for easy injection of smoke into resealable bags and containers.
- Lightweight with a comfortable handle making it easy to use with one hand.
- Powered by a rechargeable Lithium battery of 1000mAh.
- Very complete, comes with 3 spare filter meshes, a tweezer and USB charging cable.
- Wood or herbs for smoking not included.

code	mm
199640	215x70x(H)160

Smoke infuser tube opening



199664

199657

GLASS DOME WITH VENT

- Made from borosilicate glass, fitted with silicone vent to hold the tube of a smoking gun.
- Ideal to use in combination with a smoking gun.

code	-	mm
199664	Plate dome	ø260x(H)174
199657	Cocktail dome	ø130x(H)282



199978

GLASS DOME

- Ideal to use in combination with the smoking gun.

code	mm
199978	ø275x(H)140



198124

GAS LIGHTER – SET OF 2 PCS.

- Refillable.
- Supplied empty.

code	packed per	mm
198124	2	(L)230



CREAM WHIPPERS



588017



588024



Watch the video



CREAM WHIPPER PROFI LINE

- Makes delicious whipped cream, mousses, desserts, cold foams and sauces easily.
- Perfect for garnishing cappuccinos, coffees, shakes and ice cream.
- Suitable for dispensing warm creams and sauces up to 70°C.
- Keeps contents fresh for up to 14 days in the refrigerator.
- Includes 3 stainless steel nozzles and a cleaning brush.
- Requires cream charger [N₂O] to operate, not included.

code	liters	mm
588017	0.5	ø85x(H)235
588024	1	ø98x(H)330



589205

SPARE PARTS SET

code		mm
589205	Profi Line	120x30x(H)240



for cream

for liquid

for decorating

for decorating

PROFI LINE DECORATING AND INJECTOR TIPS

- Ideal for decorating, filling, injecting, marinating, etc.
- Set of 4 stainless steel tips:
 - 1 long injector tip ø3x(H)106 mm.
 - 1 long injector tip ø5x(H)106 mm.
 - 1 short injector tip ø3x(H)40 mm.
 - 1 short injector tip ø5x(H)40 mm.
- Suitable for use only with HENDI Profi Line cream whippers.

code
589106



CREAM WHIPPER KITCHEN LINE

- Aluminium head and white coated aluminium bottle.
- With 3 different nozzles, charger holder as well as a cleaning brush.
- Not suitable for hot sauces.
- Requires cream charger (N₂O) to operate, not included.

code	liters	mm
588031	0.25	ø80x(H)200
588369	0.5	ø80x(H)260
588376	0.95	ø95x(H)320

SPARE PARTS SET

code		mm
589007	Kitchen Line	120x30x(H)240



589007



KITCHEN LINE CREAM WHIPPER

- Matte black coated aluminium bottle and head.
- Not suitable for preparing hot sauces.
- Supplied with: 3 different polypropylene nozzles and a cleaning brush.
- To be used with cream whipper chargers (N₂O) (chargers not included).

code	liters	mm
588420	0.5	ø80x(H)260



588420





UNIVERSAL
FOR ALL
WHIPPED
CREAM
MAKERS

588208



588215



586907



CREAM WHIPPER CHARGERS

- Suitable for commercially available cream dispensers.
- N₂O
- Best before 5 years after production date.

code	packed per
588208	10
588215	24
586907	50



18/10
stainless steel

ICE CREAM SPATULA

code	colour	mm
755808	Blue	(L)260
755815	Red	(L)260
755822	Yellow	(L)260
755839	Purple	(L)260

755808

755815

755822

755839



755556



755686



755655

stöckel



STÖCKEL ICE CREAM DIPPER

code	-	mm
755556	1/20	ø56x120
755563	1/24	ø51x120
755570	1/30	ø49x120

ICE CREAM DIPPER STÖCKEL

- With ceramic coating and extra long handle.

code	-	mm
755686	1/20	ø56x170
755693	1/30	ø49x170

ICE CREAM DIPPER STÖCKEL

- With extra long handle.

code	-	mm
755655	1/20	ø56x170



759301



ICE CREAM DIPPER

- Made of aluminum.
- Light weight.
- Long and comfortable handle filled with oil for better portioning - the oil heats up through the heat of the hand, making it easier and quicker to release the ice cream.
- NOTE: Not dishwasher safe.

code	-	mm
759301	1/30	ø56x225



755730



ICE CREAM CONES STAND

- Fits 3 cones.

code	mm
755730	200x95x(H)85



PROFI LINE ICE CREAM SCOOP

code	-	mm
759233	1/24	ø51
759240	1/30	ø49
759257	1/36	ø46
759264	1/40	ø44



KITCHEN LINE ICE CREAM SCOOP

code	-	mm
572016	1/10	ø70
572313	1/20	ø56
572115	1/12	ø66
572214	1/16	ø59
572412	1/24	ø53
572511	1/30	ø50
572610	1/36	ø48
572719	1/40	ø44

ICE CREAM SCOOP STÖCKEL

- Perfect choice not only for ice cream, but also for serving mashed potatoes.
- Easy to keep portions identical in size.



stöckel

code	-	mm
755006	1/4	ø100
755013	1/8	ø80
755020	1/10	ø70
755037	1/12	ø67
755044	1/16	ø59
755051	1/20	ø56
755068	1/24	ø51
755075	1/30	ø49
755082	1/36	ø47
755099	1/40	ø45
755105	1/50	ø43
755112	1/60	ø40
755143	1/100	ø30





STÖCKEL ICE CREAM SCOOP

- Fiberglass-reinforced nylon handle.
- Better portion size identification thanks to colored markers.
- Made of stainless steel.

Identify the portion size with ease



code	-	mm
755334	1/12	ø67
755341	1/16	ø59
755358	1/20	ø56
755365	1/24	ø51
755372	1/30	ø49
755389	1/36	ø47
755396	1/40	ø45



STÖCKEL OVAL ICE CREAM SCOOP

code	-	mm
755259	1/20	70x52
755273	1/30	62x43



ICE CREAM SCOOP WASHER

- Facilitates quick and thorough washing of ice cream scoops and other small ice-cream accessories.
- Enables cleaning with low water consumption.
- Very easy to use and clean.
- Can be mounted on a wall with item 802014 or on refrigerated display counters and food equipment.
- 3/8" water supply line, 3/4" drainage line.
- Made of stainless steel AISI 304.



802007

code	mm
802007	270x111x(H)115

MOUNTING BRACKET FOR SCOOP WASHER

- Secure your HENDI scoop washer 802007 securely with this mounting bracket.
- Mounting holes: ø4.5 mm.
- Number of mounting holes: 2 x 2.
- Steel thickness: 0.8 mm.



802007

code	mm
802014	302x115x(H)122

802014





ICE CREAM MAKER

- Ideal for making ice cream, sorbets and frozen yoghurt in up to 90 minutes.
- 2L ice cream container made of stainless steel.
- Air-cooled compressor with temperature range: -10°C to -35°C.
- With 2 hours cooling extension function to help keep the ice's consistency after it's ready.
- Prior chilling of ingredients not necessary.
- Large, back-lit digital display showing working time, freezing temperature and motion of the mixer.
- Easy to mount mixing paddle made of polypropylene.
- Transparent polycarbonate lid with "Twist-Lock" safe close system.
- Measuring cup and spoon included.
- Refrigerant: R600a.

code	V	W	mm
274231	230	180	272x315x(H)362

Measuring cup and spoon included

274231



COUNTERTOP FREEZER DISPLAY 77L

- Intended for presentation and serving up to 4 hours. Not intended for long term storage of frozen produce.
- Body made of high-quality stainless steel, fitted with triple glazed cover with easy opening system.
- Forced air cooling with auto-defrost, compressor placed next to the chamber.
- Fits 8x GN 1/6 GN containers or 4x GN 1/3 containers (max. height 100 mm), not included.



- With 4 adjustable stainless steel feet.
- Digital temperature controller and display.
- Refrigerant: R290.
- Climate class: 4.
- Energielabel: E (A-G).

code	range	V	W	mm
233689	-24/-20°C	230	220	805x666x(H)305

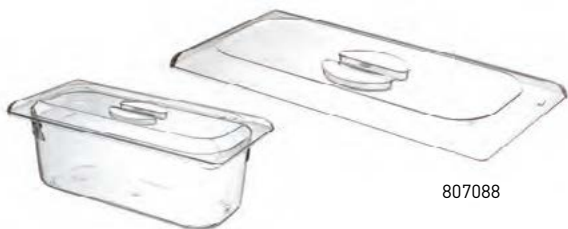

807088

ICE CREAM CONTAINER LID POLYCARBONATE

– Suitable for polycarbonate ice cream containers.



code	mm
807088	360x165
807095	360x250

807026

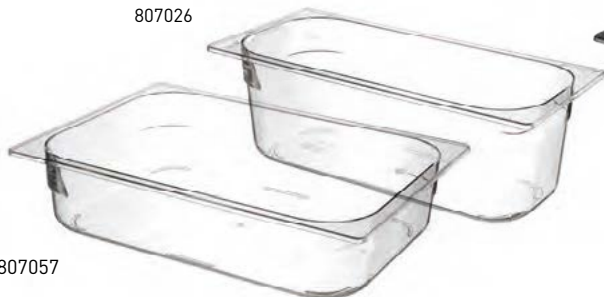

807057



807033

807071



POLYCARBONATE ICE CREAM CONTAINER

code	colour	liters	mm
807026	<input type="checkbox"/> Transparent	5	360x165x(H)120
807033	<input checked="" type="checkbox"/> Black	5	360x165x(H)120
807057	<input type="checkbox"/> Transparent	5	360x250x(H)80
807071	<input checked="" type="checkbox"/> Black	5	360x250x(H)80



802021

802038

802045

802052



PROFI LINE ICE CREAM CONTAINER

- Stainless steel 0.8 mm thick.
- Robust construction.
- Rounded edges for easy cleaning.
- Can be used in refrigerators and freezers.

code	liters	mm
802045	3.6	360x165x(H)80
802052	5	360x250x(H)80
802038	5	360x165x(H)120
802021	6.5	360x165x(H)150

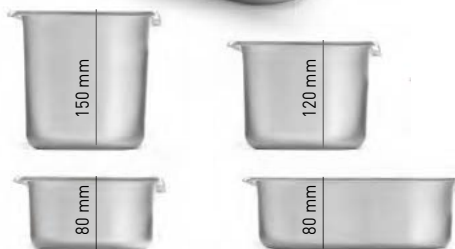

KITCHEN LINE ICE CREAM CONTAINER

- Solid design.
- Rounded edges for easy cleaning.
- Can be used in refrigerators and freezers.
- Made of stainless steel.

code	liters	mm
807019	5	360x165x(H)120



807019





**PERFECT FOR
PREPARING FREDDO
CAPPUCCINO,
FRAPPÉ AND
MILKSHAKES**



design by
Robert Bronwasser



Powerful motor with two speeds:
15,000 and 19,000 rpm.



221600

221617

221624

221631

221648

221655

2 sets of replaceable
polycarbonate stirrers
(2 pieces each)



2 cups: made of stainless
steel (capacity: 0.95 l)
and of polycarbonate
(capacity: 0.9 l)

221631

MILKSHAKE MIXER - DESIGN BY BRONWASSER

- Designed by Dutch Designer Robert Bronwasser and available in 6 attractive colours.
- Make Freddo cappuccinos, Frappés and of course milkshakes without effort.
- The housing is made from ABS plastic.
- The base is weighted for extra stability and is fitted with rubber feet.
- The motor can spin the agitator disc at two speeds, 15,000 and 19,000 RPM.
- Control the milkshake mixer with the two-speed switch on the top which is easily accessible.
- The milkshake mixer is fitted with a micro switch so it can only operate when the cup is properly placed.
- Choose between two different stirrers to control the level of aeration.
- Very complete, comes with a stainless steel mixing cup (0.95 liter) and polycarbonate mixing cup (0.9 liter) and 2 sets of 2 stirrers.
- Cups and stirrers are dishwasher safe.

code	colour	V	W	mm
221617	White	230	400	170x196x(H)490
221600	Black	230	400	170x196x(H)490
221624	Caramel	230	400	170x196x(H)490
221631	Yellow	230	400	170x196x(H)490
221648	Red	230	400	170x196x(H)490
221655	Blue	230	400	170x196x(H)490

NEW



MILKSHAKE MIXER BPA FREE - DESIGN BY BRONWASSER

- Designed by Dutch Designer Robert Bronwasser.
- Make Freddo cappuccinos, Frappés and of course milkshakes without effort.
- The housing is made from ABS plastic.
- The base is weighted for extra stability and is fitted with rubber feet.
- The motor can spin the agitator disc at two speeds, 15.000 and 19.000 RPM.
- Control the milkshake mixer with the two-speed switch on the top which is easily accessible.
- The milkshake mixer is fitted with a micro switch so it can only operate when the cup is properly placed.
- Choose between two different agitators to control the level of aeration.
- Included in the set: stainless steel mixing cup (0.95 liter), tritan mixing cup (0.9 liter) and a set of 2 tritan stirrers.
- Cup and agitators are dishwasher safe.

code	colour	V	W	mm
221495	Black	230	400	170x196x(H)490



POLYCARBONATE MIXING CUP FOR MILKSHAKERS - DESIGN BY BRONWASSER

- Made of durable polycarbonate.
- To be used with milkshakers:
- 221600, 221617, 221624, 221631, 221648, 221655.
- Dishwasher safe.



961124

code	mm
961124	ø116x(H)161



STAINLESS STEEL MIXING CUP FOR MILKSHAKERS - DESIGN BY BRONWASSER

- Made of stainless steel.
- To be used with milkshakers:
- 221600, 221617, 221624, 221631, 221648, 221655.
- Dishwasher safe.



961117

code	mm
961117	ø113x(H)160



NEW

STIRRERS BPA-FREE FOR MILKSHAKE MIXERS - DESIGN BY BRONWASSER

- Made of tritan - BPA-free material.
- The set includes 2 pieces: single and double stirrer.
- Specially created for the HENDI Milkshake mixer - Design by Bronwasser, code: 221495.
- Dishwasher safe.



957066

code	mm
957066	32x27x(H)50



NEW

STIRRERS FOR MILKSHAKE MIXERS - DESIGN BY BRONWASSER

- Made of polycarbonate.
- The set includes 2 pieces: single and double stirrer.
- Specially created for the HENDI Milkshake mixers - Design by Bronwasser: codes 221600, 221617, 221624, 221631, 221648, 221655, 221495.
- Dishwasher safe.



961131

code	mm
961131	32x27x(H)50





Strong and durable

Non-toxic

Odorless

For warm and cold masses



557105

PAstry BAGS

- Disposable.
- Suitable for hot and cold mass.
- Meets HACCP standards.
- Film thickness: 80 microns.
- Package - roll of 100 pcs.



code	mm
557112	445x220
557105	530x285



557303

PAstry BAG ANTI SLIP - 100 PCS

- Disposable bags.
- Suitable for hot and cold preparation.
- Meets hygienic HACCP standards.
- Material thickness 80 micron.
- Roll of 100 in box.

code	packed per	mm
557303	100	515x280

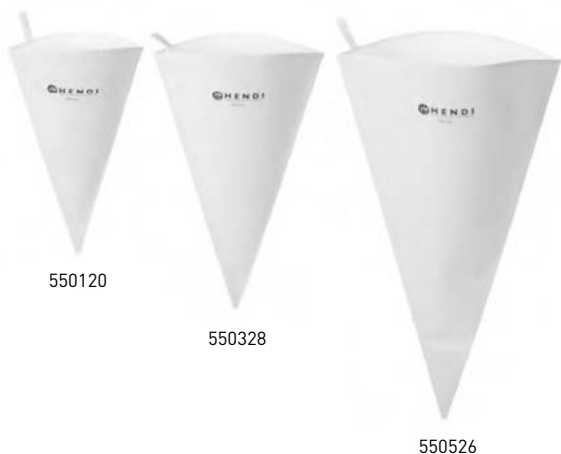

PASTRY BAGS – SET OF 2 PCS.

- Reusable (suitable for cleaning in boiling water).
- Made of cotton, inside coated with polyurethane.
- With an eyelet.

code	packed per	mm
550120	2	(L)300
550229	2	(L)350
550328	2	(L)400
550427	2	(L)450
550526	2	(L)500

PASTRY BAGS

- Made of seamless super nylon.
- Heavy duty, with a hang tag.
- Suitable for cleaning in boiling water.

code	packed per	mm
550106	1	(L)300
550205	1	(L)350
550304	1	(L)400
550403	1	(L)450
550502	1	(L)500



WALL RACK FOR PASTRY BAGS

- With 4 slots for hanging icing bags.
- There are also 31 supports for storing icing tips. Comes with 7 hooks to hang tools like spatula's and a small rack for little accessories.

code	mm
550113	500x360x(H)560





551202



ICING TIPS

- A set of 5 icing tips:
- 2 closed Star tips.
- 1 drop Flower tip.
- 1 french Star tip.
- 1 v-shaped tip.
- Extra precise thanks to sharp edges.

code

551202



ICING TIPS - SERRATED

- Set of 5 sizes.

code

551790

ø6-8-10-12-14



ICING TIPS - SMOOTH

- Set of 5 sizes.

code

551691

ø2-4-6-8-10



18/10
stainless steel

551592



ICING TIPS

- A set of 5 different icing tips for:
 - filling.
 - macarons.
 - decorating.
 - basket weave.
 - writing.
- Extra precise thanks to sharp edges.

code

551592



PP
polypropylene

8 10 12 14 16 18 20



551110



ICING TIPS - SERRATED

- Set of 7 sizes.

code

551110

ø 3-5-7-9-11-13-15

4 6 8 10 12 14 16



551011



ICING TIPS - SMOOTH

- Set of 7 sizes.

code

551011

ø 5-7-9-11-13-15-17

PP
polypropylene



551400



ICING TIPS

- Set of 12 different icing tips in a box.

code

551400

ø 6-8-10-12



CUPCAKE MOULD



code	-	mm
689806	with smooth rim	ø70x(H)68
689608	with rolled rim	ø70x(H)68



CAKE MOULD

- Rectangular.

code	mm
682104	180x80x(H)60
682302	260x100x(H)75
682401	300x110x(H)75



FOOD RING AND PUSHER SQUARE

- Perfect for plating food in refined shapes.

code	-	mm
512166	food ring	65x65x(H)45
512173	food ring	80x80x(H)45
512227	pusher	63x63x(H)55
512234	pusher	80x80x(H)55

FOOD RING

- Made of AISI 430 stainless steel.
- Dishwasher safe.

code	-	mm
512142	food ring	ø80x(H)45
512159	food ring	ø100x(H)45
512203	pusher	ø80x(H)55
512210	pusher	ø100x(H)55

FOOD RING ROUND

- Made of AISI 430 stainless steel.
- Dishwasher safe.

code	mm
512135	ø60x(H)45
512104	ø70x(H)45
512302	ø90x(H)45

DOUGH SCRAPERS



554432



554364



554166

DOUGH SCRAPERS TRAPEZOIDAL – SET OF 3 PCS.

code	packed per	mm
554432	3	216x128

DOUGH SCRAPERS RECTANGULAR – SET OF 6 PCS.

code	packed per	mm
554364	6	120x96

DOUGH SCRAPERS SEMI-CIRCULAR – SET OF 6 PCS.

– Flexible.

code	packed per	mm
554166	6	120x88



855751



553404



DOUGH CUTTER

– Stainless steel with polypropylene handle.

code	mm
855751	150x110



CAKE KNIFE

code	mm
553404	150x110



673416



674413

PASTRY CUTTERS, ROUND – SET

– Round.

– 14-piece set, different sizes.



code		mm
673416	with plain edge, ø19-112	(H)35
674413	with serrated edge, ø18-108	(H)35

5 WHEEL DOUGH CUTTER

– Cutting width can easily be adjusted from 13 to 125 mm.

– With 5 smooth ø55 mm stainless steel cutting wheels.



code	mm
515044	222x56x(H)55



515044



PALETTE KNIFE
- With flexible offset blade.

code	blade length (mm)	mm
855775	110	19x220
855782	200	32x343
855683	254	37x390



SPATULA
- For confectionery substances.
- Smooth flexible blade.

code	blade length (mm)	mm
855706	110	17x220
855690	203	34x345
855744	255	37x400



DOUGH PUNCH ROLLER
- 60 mm wide roller with 32 long, robust plastic spikes for punching dough.
- Ideal for deaerating shortcrust pastry and pizza dough.
- Prevents air bubbles and ensures better baking results.
- Made of polypropylene.

code	mm
515037	210x73



BAIN-MARIE PAN
- Double walled, with resevoir for water.
- Fill the resevoir with water to melt chocolate au bain-marie.
- With stainless steel handle.

code	liters	mm
833032	1	330x165x(H)95



NON-STICK SILICONE BAKING MAT

code	thickness (mm)	mm
677827	0.7	600x400
677810	0.7	530x325
677834	0.7	300x400



677810

BUTTER AND FAT BRUSH WITH STAINLESS STEEL BRISTLES

- High temperature resistant.
- Wooden handle.



code	mm
515389	200x25
515396	220x50



515389



515396



515228



515327

BUTTER AND FAT BRUSH WITH NATURAL BRISTLES - SET OF 2 PCS.

- Pig bristle.
- Handle made of beech wood.



code	packed per	mm
515228	2	190x20
515327	2	210x40



515358



515365

BUTTER AND FAT BRUSH FLAT SILICONE

- Polypropylene handle.

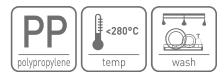

code	mm
515358	220x32
515365	230x45





659304

659403

SCRAPER

- ABS handle, blade made of synthetic rubber.

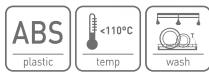

code	blade length (mm)	mm
659205	90	52x257
659304	116	70x358
659403	116	70x410

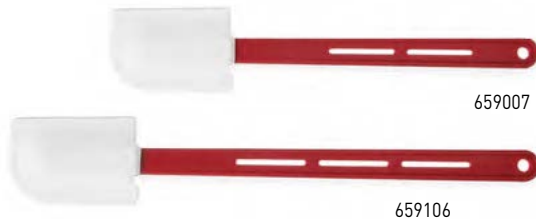

659007

659106

SCRAPER

- ABS handle.
- Silicone blade.



code	blade length (mm)	mm
659014	90	55x266
659007	105	70x354
659106	105	70x420



658604

658802

658901

SCRAPER

- Handle made of glass-fiber reinforced nylon.
- Blade made of natural rubber.
- Only suitable for cold food preparation.



code	blade length (mm)	mm
658604	90	55x240
658703	90	75x320
658802	90	75x425
658901	150	100x515



659458

659458

659472

SCRAPER SPOON SHAPED

- ABS handle.
- Blade made of synthetic rubber.

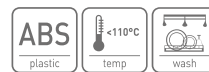

code	blade length (mm)	mm
659472	117	75x408
659458	88	57x254
659465	117	75x357



563007

563106

SPOON



code	mm
563106	450x80
563007	375x70
563205	575x105



659700

659809

SPOON

- Made of reinforced polyamide.



code	mm
659700	(L)305
659809	(L)385



525005

WOODEN SPOON - SET OF 3, VARIOUS SIZES

- For professional use in gastronomy
- Versatile use
- Elegant, classic shape
- Made of beech wood
- ATTENTION: Not dishwasher safe



code	mm
525005	(L)475

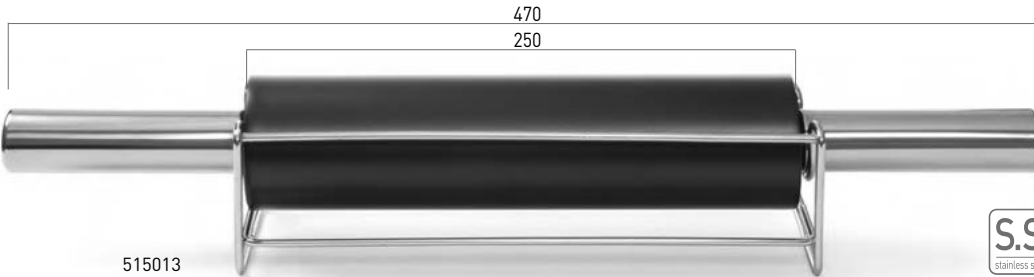

STAINLESS STEEL ROLLING PIN
- With slide bearings.

code	mm
515006	ø62x470

ROLLING PIN WITH NON-STICK COATING
- With slide bearings.

- Including chrome-plated storage stand.

code	mm
515013	ø62x470

WOODEN ROLLING PIN
- Roller width: 380 mm.
- With ball bearings.

code	mm
515020	ø75x590

for powdered sugar mesh size 0,5x0,5 mm



for flour and meal mesh size 1x1 mm

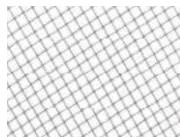

for bread-crumbs mesh size 3x3 mm

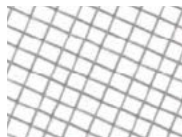

637791



BAKERS' SIEVE
- With hanging loop.

code	-	mm
637791	for powdered sugar	ø250x(H)75
637821	for powdered sugar	ø410x(H)80
637807	for flour and meal	ø250x(H)75
637838	for flour and meal	ø410x(H)80
637814	for bread-crumbs	ø250x(H)75
637845	for bread-crumbs	ø410x(H)80





SILICONE MOULDS

- Made of 100% non-stick silicone.
- Perfect for: baking, freezing, creating monoportions.

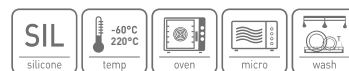

676202



676202

SEMI-SPHERE

code		baking (mm)	moulds
676202	GN 1/3	ø70x(H)32	6



677001

MINI-CAKE

code		baking (mm)	moulds
677001	GN 1/3	80x30x(H)33	9



676509

TARTELETTE

code		baking (mm)	moulds
676509	GN 1/3	ø50x(H)17	15



676905

MUFFINS

code		baking (mm)	moulds
677209	GN 1/3	ø69x(H)40	6
676905	GN 1/3	ø53x(H)30	11



677506

CANNELE BORDELAIS

code		baking (mm)	moulds
677506	GN 1/3	ø54x(H)48	8



676707

MADELEINES

code		baking (mm)	moulds
676707	GN 1/3	70x47x(H)17	9



Watch the video



198209



198223



199046

CHEFS TORCH

- Gas, refillable - automatic ignition.
- Torch is supplied empty.
- Complete with base.

code	mm
198209	145x70x(H)190

CHEFS TORCH

- Gas, refillable - automatic ignition.
- Torch is supplied empty.
- Complete with base.

code	mm
198223	115x50x(H)155

GAS CANISTER

- With various filling nozzles.

code	packed per	liters
199046	4	0.2



783153

783160

783177

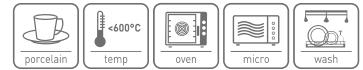

RAMEKIN

- Ribbed, made of porcelain.

code	order unit	mm
783153	12	ø70x(H)35
783160	6	ø90x(H)48
783627	6	ø100x(H)25
783177	6	ø120x(H)55





design by
Robert Bronwasser

TEMPERATURE STABILISER

From the first second of operation, the burner reaches the optimum flame temperature of 1300 °C.
BLUE HEAT REPEATABLE

GILL-TYPE AIR INTAKE

The air inlets on the burner increase the air intake capacity.
HIGH FLAME POWER,
SOOT FREE COMBUSTION



PRECISE FLAME CONTROL

Ideal for browning sugars, proteins, cheeses, fruit, vegetables and meat.
FLAME LENGTH ADJUSTABLE
UP TO 150 MM

LONG 100 MM NOZZLE

- safe flambéing
 - precise placement of the fire zone
 - maximum separation of the hand from the high temperature
- COMFORT and FREEDOM

QUICK INSTALLATION

Quickly install the cannister thanks to the clear markings on the SAFETY COVER. One click and the cannister is SAFELY replaced.
YOU CAN BE SURE THAT THE CANNISTER HAS BEEN INSTALLED CORRECTLY

HENDI JET CHEFS' TORCH

- Designed with chefs in mind by Robert Bronwasser.
- This torch is a pleasure to use thanks to the stylish matt black design with green accents and the ergonomic grip.
- The torch is easily and securely attached to the gas cartridge (it's possible to replace it after gas runs out) and covers the whole top of the cartridge.
- The piezo ignition makes it easy to ignite, the large gas dial allows for easy adjusting the flame size and intensity.
- This chefs torch can operate at every angle, even upside down, thanks to the improved design of the burner that prevents flaring.
- Precise flame control, flame length up to 150 mm.
- Cartridges can be purchased separately, code: 199039.

code	-	mm
198247	HENDI Jet chefs' torch	185x65x(H)100
198254	HENDI Jet chefs' torch – set with gas cartridge	175x68x(H)260



198247

199039



VERTICAL WORK – Gen 2.0

- flame burns without flickering under every angle, even upside down / 360 degrees.
- the flame does not retract towards the burner and the hand

VERSATILE AND SAFE

DESIGNED TO BE EASY TO SPOT

Contrasting colours allow you to immediately locate the device among your kitchen utensils.

GAS COVER

Made of a cover plate and a single pass-through valve, it prevents interference from flashback flames. SAFETY

RELIABLE

Pressing the ignition button generates an electrical voltage that ignites the gas. PULL THE TRIGGER AND IT WORKS – NO REPLACEMENT OF FLINTS NECESSARY

DESIGNED TO MEET CULINARY NEEDS

Thanks to the construction and materials, the burner is very strong and yet lightweight. GO FOR QUALITY – USE A TOOL THAT WILL LAST FOR YEARS



199039

LPG GAS CARTRIDGE

- Suitable for use in combination with HENDI Chefs torches 198247 & 198216.
- Not suitable for refilling gas lighters etc.
- Packed per 4 canisters.
- Order unit: box with 7 sets of 4 cans.

code	packed per	weight (kg)
199039	4	0,227





Big inlet for inserting big pieces of vegetables

Small inlet for inserting small pieces of vegetables



5 discs included,
2 for slicing
3 for grating



Watch the video



VEGETABLE CUTTER PROFI LINE

- Suitable for cutting large quantities of vegetables.
- 6 discs included: slices 2 mm thick (3 blades), slices 4 mm thick (2 blades), 3 mm grater, 4,5 mm grater, 7 mm grater, ejector disc.
- Big inlet with lever for inserting big pieces.
- Small inlet with pusher for inserting smaller pieces.
- Cast aluminium housing.
- 2 security systems: first - screw locks the cover, second - electromagnetic sensor (opening the cover turns off the machine).
- Speed: 295 RPM.
- Productivity: 100 - 300 kg/h
- Weight: 27.6 kg

code	V	W	mm
231807	230	550	540x240x(H)450

231807



280096

SLICING DISC

- For vegetable cutter 231807 & 231852.

code	thickness (mm)
280126	4
280096	1
280102	2
280201	6
280218	8
280225	10

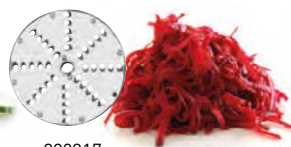

280317

GRATING DISC

- For vegetable cutter 231807 & 231852.

code	thickness (mm)
280317	7
280294	2
280300	3
280416	4,5



234730

DICING DISC

- For vegetable cutter 231807 & 231852.
- Must be used in combination with a slicing disc (234730 + 280218, 234747 + 280225).

code	thickness (mm)
234747	10
234730	8



234754

FRENCH FRIES CUTTING DISC

- For vegetable cutter 231807 & 231852.
- Must be used in combination with a slicing disc (234754 + 280218, 234761 + 280225).

code	thickness (mm)
234761	10
234754	8





5 discs included,
2 for slicing
3 for grating



Watch the video



Small inlet for
inserting small
pieces of vegetables

Big inlet for
inserting big pieces
of vegetables

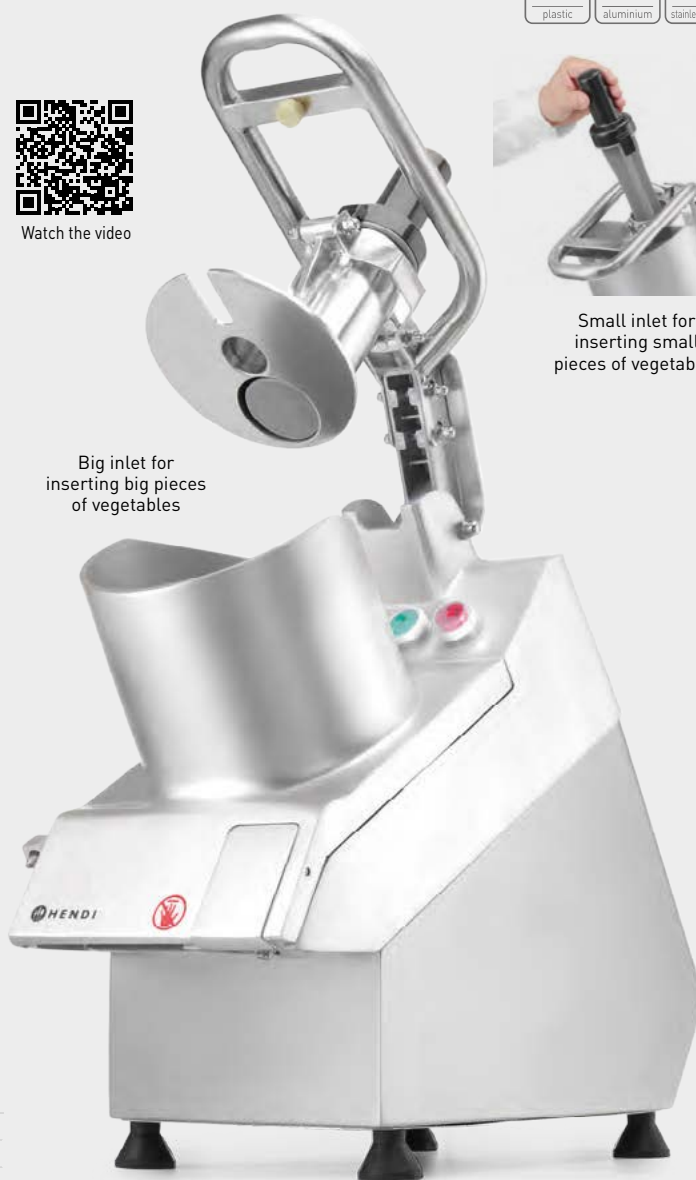

231852

VEGETABLE CUTTER HEAVY DUTY

- Designed for cutting large amounts of vegetables.
- Large inlet for large vegetables, up to Ø 165 mm.
- Small inlet for long vegetables, i.e. carrots, cucumbers up to Ø 55 mm.
- Cutting chamber housing made of cast aluminium, bottom part of the housing made of stainless steel.
- Convenient pressing handle.
- 750W = 1hp air-cooled high-performance motor.
- Low-voltage control buttons: STOP, START (24 V).
- 2 security systems: cutter switches off upon lifting of the pressing handle and upon lifting of the upper cover of the chamber.
- Upon lowering of the pressing handle the cutter starts automatically.
- Easy and fast replacement of cutting disks.
- 5 cutting discs included: 2 mm slices (disc with 3 blades) 4 mm slices (disc with 3 blades) 3 mm grater 4,5 mm grater 7 mm grater Evacuation disc.
- 4 rubber anti-slip feet.
- Speed: 300 RPM.
- Productivity: 100 – 350 kg/h
- Weight: 25 kg.

code	V	W	mm
231852	230	750	500x250x(H)470



280423

JULIENNE DISC

- For vegetable cutter 231807 & 231852.

code	thickness (mm)
280423	3



280621

RASPING DISC

- For vegetable cutter 231807 & 231852.

code
280621



918500

EJECTOR DISC FOR VEGETABLE CUTTER

- Replace your broken or lost ejector disc and extend the service life of your vegetable cutter.
- Works with HENDI vegetables cutters 231807 & 231852.

code	mm
918500	ø220



280690

RACK FOR 18 VEGETABLE CUTTER DISCS

- Capacity: 18 discs.
- Discs not included in the price.

code	mm
280690	400x250x(H)90



Watch the video



MEAT MINCER KITCHEN LINE 12

- Stainless steel feeder tray, hopper made of a special aluminium alloy.
- Knife and worm screw made of stainless steel and funnel of cast iron.
- Stuffing tube and two Ø 70 mm mincing discs with Ø 6 and 8 mm holes included.
- Easy disassembly for easy cleaning.
- Motor with an overheat protection mechanism.
- Anti-slip feet.
- Output ±1,7 kg/min.
- Not for continuous use.

code	V	W	mm
210802	230	550	432x261x(H)484

MEAT MINCER KITCHEN LINE 22

- Stainless steel feeder tray, hopper made of a special aluminium alloy.
- Knife and worm screw made of stainless steel and funnel of cast iron.
- Stuffing tube and two Ø 82 mm mincing discs with Ø 6 and 8 mm holes included.
- Easy disassembly for easy cleaning.
- Motor with an overheat protection mechanism.
- Anti-slip feet.
- Output ±3,7 kg/min.
- Not for continuous use.

code	V	W	mm
210819	230	750	427x261x(H)486

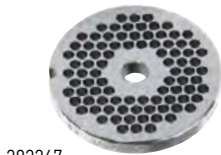

282267



PERFORATED PLATE

- Ø 70 mm.

code	suitable for	mm
282229	210802	ø8
282250	210802	ø3
282243	210802	ø4.5
282236	210802	ø6
282267	210802	ø2

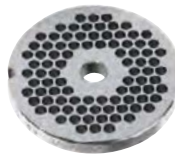

282014



PERFORATED PLATE

- Ø 82 mm.

code	suitable for	mm
282014	210819	ø8
282021	210819	ø6
282038	210819	ø4.5
282045	210819	ø3
282052	210819	ø2



933367

WORM SHAFT

code	suitable for
933367	210819
931257	210802



282359

MEAT MINCER KNIFE

code	suitable for
282359	210802
282076	210819



MEAT MINCER 198

- Ideal for small amounts and sausage making, not for commercial use.
- Aluminium housing.
- Die cast metal hopper with meat dish/dust cover.
- Pusher made of plastic.
- Aluminium worm screw and stainless steel knife.
- 2 mincing discs, diameter 65,8 mm included: 4 mm and 7 mm diameter holes.
- 3 sausage stuffing tubes: Ø 12, 15 and 20 mm.
- Steak tartare attachment.
- On/off/reverse switch.
- Not for continuous use.
- Weight 5,2 kg.

code	V	W	mm
210864	230	400	275x190x(H)347



Three sausage stuffing tubes included

Worm screw made of aluminium, blade made of stainless steel



Meat dish with dust cover

Housing made of aluminium

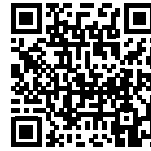

Watch the video

210864



Beef and pork tenderizer included



Watch the video

ELECTRIC MEAT TENDERIZER

- Max. meat portion size: 160 mm wide x 30 mm thick.
- Stainless steel housing.
- Supplied with a beef and pork tenderizer attachment.
- Speed of the softening knife units: 75 rpm
- Capacity: up to 800 pieces/h
- Motor cooled by a built-in fan.
- 4 rubber feet.

code	V	W	mm
975305	230	350	465x220x(H)430



S.S.
stainless steel

975305



975329



975312



976180

ROLLERS FOR POULTRY

- For use with HENDI Electric meat tenderizer 975305.
- Stainless steel case.
- 2 polypropylene pressing rollers.
- Roller length 180 mm.

code	mm
975329	235x130x(H)120

ROLLERS FOR SHOARMA

- For use with HENDI Electric meat tenderizer 975305.
- Stainless steel case and knives.
- 2 sets of knives cutting stripes 4 mm wide.
- Roller length 165 mm.

code	mm
975312	235x130x(H)120

ROLLERS FOR BEEF AND PORK

- For use with HENDI Electric meat tenderizer 975305.
- Stainless steel case and knives.
- Maximum dimensions of the meat are 160 mm wide and 30 mm thick.

code	mm
976180	235x130x(H)120

18/8

stainless steel

CAPACITY UP TO

10 L



Watch the video

Durable gear system
- made of hardened steel.

Parts that come in
contact with food are
easily removed, easing
filling and cleaning.

282151

282151

Made of stainless steel.

PROFI LINE SAUSAGE FILLING MACHINE

- Made of stainless steel.
- Equipped with a two-speed filling system:
 - quick gear for lifting the piston
 - slow gear (low load) for filling the skins with stuffing.
- Parts that have contact with food are removable for easy filling and cleaning.
- Supplied with a set of 4 stainless steel funnels, diameter: $\varnothing 16$, $\varnothing 22$, $\varnothing 32$ and $\varnothing 38$ mm, 180 mm long.
- Equipped with bearings and gear train made of hardened steel, resistant to pressure.

code	liters	mm
282571	3	304x304x(H)525
282588	5	304x304x(H)640
282090	7	300x340x(H)830
282151	10	415x315x(H)690



With a set of 4
stainless steel funnels
16/22/32/38 mm



S.S.
stainless steel

Al
aluminium

Al
aluminium

282113

HAMBURGER PRESS

- For use in professional gastronomy
- Lower housing made of anodized aluminium
- Press ram and tray made of stainless steel
- The press makes hamburgers up to $\varnothing 130$ mm
- A practical lever to release formed meat from the tray
- With integrated patty divider container
- Patty dividers are included in set

code	mm
282113	320x250x(H)300

PATTY DIVIDERS

- Made of transparent cellulose.
- High temperature resistant and biodegradable.
- $\varnothing 130$ mm.
- Packed per ± 1400 pieces.

code	packed per	mm
282120	1255	$\varnothing 130$



513026

HAMBURGER PRESS

- Makes $\varnothing 115$ mm hamburgers.
- Made of aluminium alloy with non-stick coating.
- Handle made of polypropylene.

code	mm
513026	$\varnothing 120 \times (H) 80$



513033



TORTILLA PRESS

- Makes max. $\varnothing 200$ mm tortillas.
- Made of aluminium alloy with red powder coating on the exterior.

code	mm
513033	685x250x(H)200

Al
aluminium

wash



PROFI LINE SLICER

- Housing made of coated aluminum, with non-slip feet.
- Hardened stainless steel blade, angled.
- Air-cooled motor with overheating protection.
- Powerful motor for slicing tough meats.
- Equipped with blade guard and built-in sharpener.
- Trolley with safety guard, clamping element and vertical locking device.
- Quick and easy disassembly for effortless cleaning.
- Meets all safety requirements for equipment for professional use, i.e.:

- setting the knob to "0" slicing thickness keeps the blade behind the guard.
- protection against unwanted start-up if the sharpener or the blade guard is removed.
- possibility to lock and remove the trolley only with the blade set in "0" slicing thickness position.
- Not suitable for slicing cheese.
- Cheese slicing possible with a separately available non-stick knife.



Watch the video



210031



210048

SLICER PROFI LINE 195

- Blade diameter: 195 mm.
- Steplessly adjustable slicing thickness up to 12 mm.
- Maximum slicing diameter: 120 mm.

code	V	W	mm
210031	230	200	400x400x(H)330

SLICER PROFI LINE 220

- Blade diameter: 220 mm.
- Steplessly adjustable cutting thickness up to 15 mm.
- Maximum slicing diameter: 150 mm.

code	V	W	mm
210048	230	280	440x420x(H)350



210000



210017

SLICER PROFI LINE 250

- Blade diameter: 250 mm.
- Steplessly adjustable cutting thickness up to 15 mm.
- Maximum slicing diameter: 180 mm.

code	V	W	mm
210000	230	320	485x420x(H)395

SLICER PROFI LINE 300

- Blade diameter: 300 mm.
- Steplessly adjustable cutting thickness up to 15 mm.
- Maximum slicing diameter: 200 mm.

code	V	W	mm
210017	230	420	600x480x(H)450



Slicing thickness is easy to adjust



Carriage with locking mechanism



Heavy product holder



970294

SLICER PROFI LINE 220 RED EDITION

- Blade diameter: 220 mm.
- Steplessly adjustable cutting thickness up to 15 mm.
- Maximum slicing diameter: 150 mm.
- Finished with a special red coating.

code	V	W	mm
970294	230	280	440x420x(H)350



210086

SLICER PROFI LINE 250 RED EDITION

- Blade diameter: 250 mm.
- Steplessly adjustable cutting thickness up to 15 mm.
- Maximum slicing diameter: 180 mm.

code	V	W	mm
210086	230	320	485x420x(H)395



975732



NON-STICK COATED BLADE

- For slicing cheese.

code	suitable for	mm
975800	210031	ø195
975732	210048	ø220
975749	210000	ø250
975756	210017	ø300



901915

REPLACEMENT KNIFE FOR ELECTRIC MEAT SLICERS

- Replace your knife to extend the service life of your electric slicer.
- For use with HENDI Slicers Profi Line 210215, 210017, 210086.

code	mm
901915	ø250
901922	ø300





POTATO PEELERS KITCHEN LINE



- Intended for professional use, ideal for industrial kitchens, institutional kitchens or any kitchen that must peel fast amounts of potatoes and other root vegetables a day.
- Peels the potatoes by means of an abrasive disc and abrasive pads on the inside of the drum.
- Drum, disc and abrasive pads made of high-quality stainless steel, resulting in a very durable, efficient and easy to clean machine.
- Abrasive disc is fitted with aluminum alloy agitators.
- The lid is made of durable polycarbonate; lets you keep an eye on the peeling process.
- Thanks to the powerful engine peeling a single load only takes 2 to 3 minutes.
- Control panel fitted with an 8-minute timer and control lights.
- Very safe to operate, a micro switch stops the peeler when the cover is opened.
- Fitted with a freshwater and drain connection, for rinsing potatoes during peeling.
- With an effective peel collection trap, consists of 2 containers of which one is perforated, prevents the clogging of the sewage system.
- Legs are fitted with plastic feet for stability, two legs have mounting plates for secure mounting to the floor.
- Water resistance class: IP23.



229217

KITCHEN LINE POTATO PEELER, 10 KG

- Capacity: 22 l.
- Maximum load: 10 kg.
- Output: 140-200 kg/h.
- Net weight: 39.6 kg.

code	V	W	mm
229217	230	750	622x540x(H)857



229200

KITCHEN LINE POTATO PEELER, 5 KG

- Capacity: 5 kg of potatoes per load.
- Output: 70 to 100 kg per hour.
- Volume: 12L.
- Weight: 39,2 kg.

code	V	W	mm
229200	230	550	622x540x(H)802



PLANETARY MIXERS KITCHEN LINE



- Aluminium housing (code: 222829) or cast iron housing on four supports (code: 222836, 222843).
- Robust bowl made of AISI201 stainless steel.
- Supplied with 3 accessories made of AISI430 stainless steel: a whisk, a mixer and a dough hook
- 3 speeds.
- Durable worm drive made of chrome-coated steel and bronze gears.
- A lever for lowering and raising the bowl.
- Easy-to-use digital control panel (code: 222829) or analog control (code: 222836, 222843).
- Protection against activation of the mixer with the guard up or the bowl in the wrong position.
- Resettable overheating protection.
- Timer that can be set up to 60 minutes (code: 222829).

MAX CAPACITEIT

5 kg



222829



222836



222843



code	222829	222836	222843
liters	7 l	10 l	20 l
flour/dough load	0,8 kg/2 kg	2,5 kg/4 kg	5 kg/8 kg
dimensions	240x420x(H)425 mm	380x470x(H)730 mm	490x580x(H)780 mm
control	digital	manual	manual
speed	128/252/545 rpm	148/244/480 rpm	197/317/462 rpm
power/voltage	650 W/230 V	600 W/230 V	1100 W/230 V





design by
Robert Bronwasser



6 SPEEDS

Speed up. Increase your efficiency. YOU'LL ALWAYS ACHIEVE REPEATABLE RESULTS

ERGONOMIC & LIGHTWEIGHT BODY

Profiled handle for a FIRM and STRONG grip. The correct operating angle. COMFORTABLE OPERATION THANKS TO THE NATURAL POSITION

QUIET

Silent drive operation for OPEN KITCHENS. Popular with CHEFS



HENDI BLEND STICK BLENDER

- Designed with chefs in mind by Robert Bronwasser.
- ABS plastic housing and a stainless steel shaft.
- Stainless steel cross shaped blade with titanium coating.
- Powerful 250W motor, 6 speeds with LCD display.
- Maximum speed 13500 RPM.
- Suitable for processing 1 to 8 liters.

code	V	W	mm
222157	230	250	ø71x(H)444

FOR CONTAINERS AND PANS WITH A CAPACITY OF 1 TO 4 LITRES

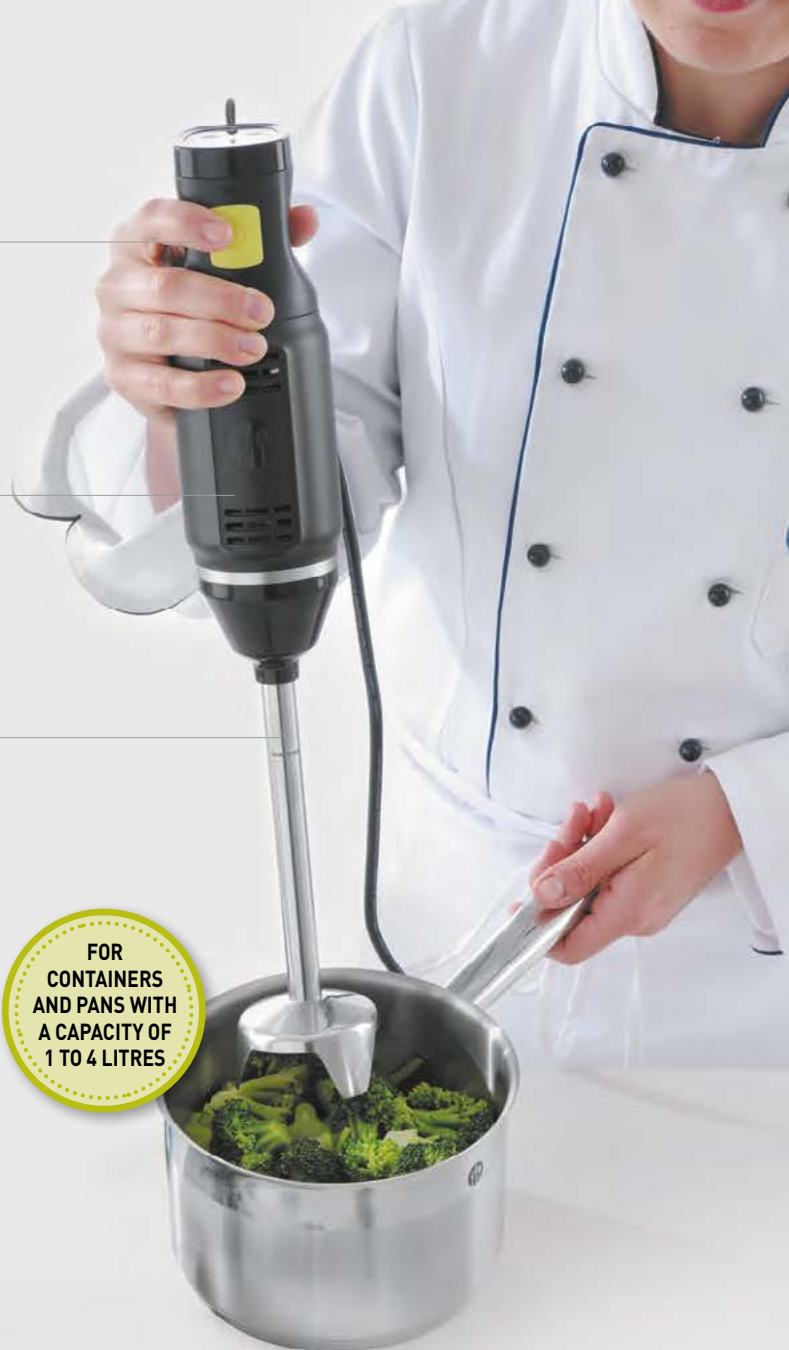

HD DESIGN

Increased breakage and scratch resistance thanks to ABS TERPOLYMER

222157

TITANIUM-COATED BLADES

3 times more durable and resistant to blunting. TITANIC DURABILITY

MORE POSSIBILITIES

20 cm long blender shaft allows you to work with high pans and containers

IMPRESSIVE SPEED RANGE

from 6,600 to 13,500 rpm. REDUCTION IN PREP TIME



STICK BLENDER KITCHEN LINE

- For professional use like preparation of vegetable soups, sauces, stuffing, mayonnaise, tomato purée, ice-cream mixtures, etc.
- Mixing speed variable: 4,000-16,000 RPM.
- Ventilated durable motor in a polyamide matt black housing.
- With 2,5 m long cord with an earthed plug.



STICK BLENDER DRIVE UNIT - VARIABLE SPEED 350W

code	V	W	mm
221884	230	350	ø100x416

STICK BLENDER DRIVE UNIT - VARIABLE SPEED 500W

code	V	W	mm
221891	230	500	ø100x416



BLENDER SHAFT FOR STICK BLENDER

- Stainless steel shaft and blade.
- Fits stick blenders Kitchen Line 221884, 221891.
- Blade removal kit included.

code	mm
222232	(L)300
222225	(L)250
222249	(L)400
222256	(L)500



WHISK ATTACHMENT FOR STICK BLENDER MOTOR 221884 & 221891

- Consists of two stainless steel whisks.
- Safe and easy attachment to the driving unit.

code	mm
222263	(L)250

STICK BLENDER KITCHEN LINE 160 WITH ADJUSTABLE SPEED

- For professional use in ice-cream shops, restaurants, hotel kitchens for preparing ice cream mixes, vegetable soups, purees, sauces, stuffing, mayonnaise, tomato paste, pesto, etc.
- Ventilated motor.
- Housing with ergonomic handle made of durable plastic material.
- Stainless steel shaft and blade: length 160 mm, Ø 25 mm.
- Speed: Approx. 4,000 - 20,000 RPM.
- Net weight, including shaft: approx. 1,61 kg.

code	V	W	mm
222140	230	220	ø75x(H)464



WHISK ATTACHMENT FOR STICK BLENDER 222140

- Consists of two stainless steel whisks.
- Safe and easy attachment to the driving unit.

code	mm
222164	(L)185



STICK BLENDERS PROFI LINE

- Professional version.
- Housing made of fiber reinforced nylon.
- Stainless steel shaft and blade.
- Easy to clean.



Equipped with a digital display



code	224328	224335	224397	224359	224052
	Stick blender 250 - with fixed speed	Stick blender Profi Line 300 - with adjustable speed	Stick blender Profi Line 400 - with adjustable speed	Stick blender Profi Line 500 - with adjustable speed	Stick blender Profi Line 500 set
control panel		Electronic control panel (9 speeds)	Electronic control panel (9 speeds)	Electronic control panel (9 speeds)	Electronic control panel (9 speeds)
suitable for dishes up to (l)	20	50	80	100	120
dimensions (mm)	ø75x(H)285	ø100x(H)350	ø100x(H)350	ø100x(H)350	ø100x(H)350
shaft length (mm)	250	300	400	500	500
speed (rpm)	fixed 15 000	variables 2 000 - 9 000	variables 2 000 - 9 000	variables 2 000 - 9 000	variables 2 000 - 9 000
maximum speed (rpm)		13 000	15 000	15 000	15 000
power/voltage (W/V)	250/230	300/230	400/230	400/230	500/230
weight (kg)	1,45	3,45	4,1	4,1	4,25



WHISK ATTACHMENT FOR STICK BLENDER PROFI LINE 300, 400 & 500

- Consists of two whisks.
- Easy and safe to attach.



code	mm
224342	ø120x(H)330



934029

WALL MOUNTED STORAGE RACK

code	mm
934029	365x130x(H)70



STICK BLENDER PROFI LINE 400 - ADJUSTABLE SPEED SET WITH STORAGE RACK

- Professional version.
- Housing made of fiber reinforced nylon.
- Stainless steel shaft and blade.
- Easy to clean.
- With whisk attachment and wall mounted storage rack.
- Electronic control panel.
- 9 Speed settings between 2000 and 9000 RPM.
- Capacity up to 80 liter.
- Shaft length: 400 mm.
- Weight: 4,75 kg.

code	V	W	mm
224380	230	400	ø100x(H)350



224380



STICK BLENDER VARIABLE SPEED WITH WHISK AND WALL-MOUNTED RACK

- For professional use in ice cream parlours, restaurants, hotel kitchens to prepare ice cream mixtures, vegetable soups, purées, sauces, stuffing, mayonnaise, tomato purée, pesto, etc.
- Includes variable speed mixer drive, mixing arm, whipping arm, and a wall-mounted hanger.
- Housing made of durable polyamide, matte black.
- Whipping arm, 250 mm long, consists of two stainless steel whisks.
- 400 mm-long mixing arm and blade made of stainless steel.
- For dishes of up to 60 l for mixing and 50 l for whisking.
- Speed: 4,000-16,000 RPM.
- Weight (drive only): 2.35 kg.

code	V	W	mm
222393	230	350	ø100x416



222393



STICK BLENDER 250VV - WITH ADJUSTABLE SPEED

- Professional version
- Housing made of fiber reinforced nylon
- Stainless steel shaft and blade
- Whisk attachment included (290 mm)
- Easy accessory changing clutch
- Easy to clean
- Ergonomic handle
- Shaft length: 250 mm
- Suitable for dishes up to 20 liters
- Speed control knob
- Speed: 2500 - 15000 RPM
- Weight 1,9 kg

code	V	W	mm
224373	230	250	ø75x(H)555



224373





BLENDER WITH NOISE COVER



- This blender can prepare anything: fruits, vegetables, cocktails, smoothies, desserts and even crushed ice.
- Replaceable stainless steel blades with titanium coating.
- Noise cover made of polycarbonate, for safety the blender only works when the cover is completely closed.
- Comes with 2,5L break-resistant BPA free Tritan jug, firm lid made of polypropylene and a small BPA free Tritan lid cover.

- Detachable jug can withstand temperatures of -40°C up to 90°C.
- Hi-speed motor with variable speed and pulse function drives the blades from 8350 RPM up to 24800 RPM (without load).
- Equipped with over-heat and over-current protection.



Watch the video

230688
230602



Watch the video

Noise cover reduces sound significantly

Anti-slip base

230695
230664

BLENDER WITH NOISE COVER

- Manual control panel power setting knob and a pulse switch.

code	V	W	mm
230688	230	1680	252x258x(H)547
230602	BPA free	230	1680

DIGITAL BLENDER WITH NOISE COVER

- Digital control panel has touch control for three power settings, three time settings and a pulse function.

code	V	W	mm
230695	230	1680	252x258x(H)547
230664	BPA free	230	1680

Break-resistant polycarbonate jug



Stainless steel knife with titanium coating



Solid construction of the gear



Durable metal gear socket





HIGH POWER BLENDER

- This blender can prepare anything: fruits, vegetables, cocktails, smoothies, desserts and even crushed ice.
- Replaceable stainless steel knife with titanium coating.
- Manual control panel, power setting knob and a pulse switch.
- Comes with 2,5L break-resistant polycarbonate jug, firm lid made of ABS and a small polycarbonate lid cover.
- Detachable jug can withstand temperatures of -40°C up to 90°C.
- Hi-speed motor with variable speed and pulse function drives the blades from 16000 RPM up to 24800 RPM (without load).
- Equipped with over-heat and over-current protection.

code	V	W	mm
230718	230	1680	270x250x(H)550
230213	BPA free	230	1680

Very powerful,
can even crush ice

Comes complete with
2,5L break-resistant
jug, pusher and firm lid

230718



BLENDER JAR BPA FREE

- Replacement jar for blender 230718/230695/230688/230213/230602/230664.
- 2,5L break-resistant BPA free Tritan jug, firm lid made of polypropylene and a small BPA free Tritan lid cover.
- Fitted with blades made of stainless steel with titanium coating.

code	mm
933688	200x170x(H)360



933688



BLENDER JAR WITH TITANIUM COATED BLADE

- Replacement jar for blender 230718/230695/230688/230213/230602/230664.
- 2,5L break-resistant polycarbonate jug, firm lid made of polypropylene and a small polycarbonate lid cover.
- The jar is fitted with blades made of stainless steel with titanium coating.

code	mm
943489	200x170x(H)360



943489





Be Safe Protection

- Overheating protection
- Retractable cutter
- Non-conductive hold-down arm
- Non-slip table stabilisers
- Swing guides with stops
- Overload fuse
- Illuminated switch
- Visible HOT marking

Powerful Heater

Powerful heaters reduce heating time. It only takes 8-10 minutes (depending on the set temperature). Uniform temperature across the entire sealing surface. Thermal insulation reduces heat loss.

Cutting off the Film

with an automatically retractable cutter with 133 sharp teeth. Great choice for thick films. Film is cut just behind the sealed container in a special strip based on AIR-CUT technology

Auto Lift

A system of stays for easier lifting of the heating plate. Increases efficiency.

Robust Design

The frame is made of acid-resistant steel with a thickness of over 2 mm. Solid and robust design.

Non-Stick Titanium Sealing Surface

Prevents all types of film from sticking to the surface. Quick sealing, takes 1-3 seconds (depending on film thickness).

Pressure Absorber

Easy adjustment of the force of pressure of the edge of the packaging to the heating plate. Prevents packaging from breaking. Eliminates micro-gaps and leaks.

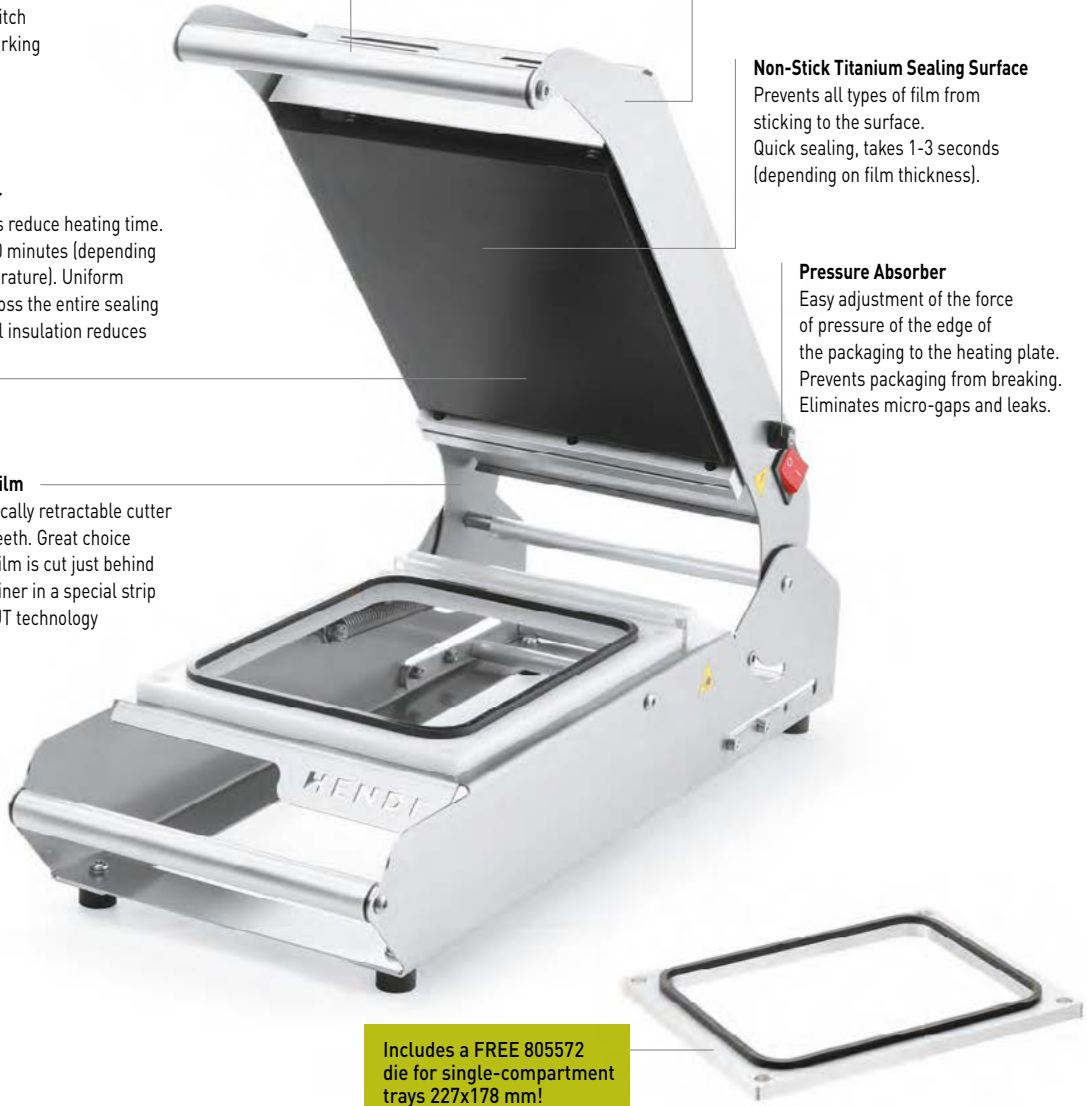

Maintenance/Safe Zone

Frame base insulated from high temperature and electrical voltage. High quality materials and seamless design for quick cleaning of the bottom part of the body, without having to turn off the device.

Hot Point Temperature Controller

Temperature controller with a range of 50-210°C. For precise adjustment of bond strength for a wide range of packaging and sealing films.

Roller Truck Film Feeder with Tensioner

Versatile device for different roller widths - max. 187 mm. JUMBO rolls up to 170 mm in diameter. The tensioner ensures even positioning of the film, prevents unwinding and excessive feeding.



18/10
stainless steel

TRAY SEALER COMPACT

- Construction made of stainless steel.
- Equipped with a lid with spring mechanism for easy and safe opening.
- Insulated handle made of damage-resistant plastic.
- Automatic guillotine with safety knife in specially designed cover; cutting takes place just behind the sealed container in a special strip (air-cut technology).
- Anti-slip feet protecting the tabletop from scratching.
- Sealing surface has titanium coating that prevents film sticking and enables a fast seal in 1-3 seconds (depending on film thickness).
- Pressure absorber ensures a tight seal and prevents packages from crushing.
- Colour-coded LEDs for monitoring the performance.
- Overheat lock, overheat protection, illuminated safety switch.
- Warm-up time after start-up to full operational mode - approximately 8-10 minutes.
- Sealing of trays up to: 235x190x(H)155 mm and cups up to: (H)170 mm.
- Maximum film roll size: width 187 mm, ø170 mm - film sold separately (code: 970720).
- Equipped with aluminium die for 227x178 mm containers (code: 805572), without divider.

code	V	W	mm
330005	230	700	610x214x(H)190



330005

TRAY SEALER HENDI MATRIX

- Made of polished aluminium.
- Black silicone seal.

shape	code	type
	805572	for a single-compartment 227x178 mm tray
	805589	for two 178x113 mm trays
	805596	for a 227x178 mm two-compartment tray
	805619	for large soup container ø165 mm
	805626	for a three-container 227x178 mm tray

shape	code	type
	805633	for two soup containers ø115 mm
	805640	for a colt 227x178 mm two-compartment tray
	805657	for a single-compartment 178x113 mm tray + ø115 mm container
	805664	for a single-compartment 187x137 mm tray

FILM FOR PET/CPP PEEL 12/40 SEALERS

- Designed for packaging PET 12 / CPP 40 food trays.
- PEEL layer for easy peeling off the sealed film.
- Film dimensions: width: 18.5 cm, length: 250 lm.
- Roll diameter: ø15 cm.
- Film roll weight: approx. 2.9 kg.
- Suitable for the HENDI tray sealer (330005).

code
970720



970720



VACUUM CHAMBER PACKAGING MACHINE KITCHEN LINE

- For professional use in the catering industry and other industries
- Durable design – high-quality stainless steel casing and chamber
- Transparent lid made of durable high-quality ABS plastic makes it possible to control the – packaging process
- Convex lid makes it possible to pack large portions
- Bag sealing time: 0-6 s
- 6 vacuum levels to choose from
- Sealing only function
- Marinating function: 11 cycles of extracting and letting air into the bag (one cycle takes 9 min); thanks to negative pressure, marinade penetrates into the product faster, which significantly speeds up the whole process
- The packing cycle starts automatically when the upper lid is closed
- Professional and highly efficient rotary pump
- Intended for continuous operation

VACUUM CHAMBER PACKAGING MACHINE PROFI LINE

- For professional use in the catering industry and other industries
- For packing food and technical products, including those with a high water content
- Durable design – casing and chamber made of high-quality AISI 304 stainless steel
- Transparent lid made of durable high-quality ABS plastic makes it possible to control the packaging process
- Convex lid make it possible to pack large portions
- V-shaped gasket with a low leak rate
- Clear indicators (digital display and dial gauge) make it possible to pinpoint the moment when the required vacuum level is reached in the chamber of the packaging machine
- Adjustable pump operation time makes it possible to obtain an appropriate vacuum level in 0-99 s
- Adjustable sealing time within the range of 0-3.5 s
- Adjustable pump cooling level within the range of 0-9.9 s
- The packing cycle starts automatically when the upper lid is closed
- Oil pump ensures a short and very efficient packing cycle
- To be used with smooth and embossed bags



975398



975268

code	975398	975268	975275
dimensions	359x429x(H)345 mm	370x480x(H)435 mm	425x560x(H)460 mm
chamber dimensions	350x300x(H)110 mm	320x370x(H)185 mm	370x450x(H)220 mm
seal strip	295 mm	300 mm	350 mm
pump performance	77 l/min	133 l/min	333 l/min
power/voltage	630 W/230 V	370 W/230 V	750 W/230 V
weight	24,4 kg	38 kg	62 kg

VACUUM CHAMBER PACKAGING MACHINE PROFI LINE

- Adjustable cycle and sealing time, automatic and manual operation.
- Suitable for vacuum packing liquid and wet food.
- With marinate function.
- Fitted with a digital display and a manual pressure gauge.
- High quality oil pump which provides high pressures (1009mbar) and fast vacuum speed.
- Body and chamber made of high quality stainless steel.
- Large recess in the bottom and domed transparent cover allow for packing large portions.



Watch the video

NEW



936801

TEFLON TAPE FOR TOP SEALBAR

- 65mm wide, 1 meter long.
- For HENDI Vacuum machines

code

936801



201435

code	201435	201442
dimensions	359x425x(H)356 mm	505x567x(H)465 mm
chamber dimensions	300x350x(H)110 mm	425x457x(H)100 mm
seal strip	300 mm	410 mm
pump performance	8 m ³ /h - 133,3 l/min	20 m ³ /h - 333,3 l/min
power/voltage	950 W/230 V	1100 W/230 V
weight	27 kg	58,8 kg





970362

PROFI LINE STRIP VACUUM PACKAGING MACHINE

- For packaging of food and non-food products, excluding liquids.
- Housing made of AISI 304 stainless steel.
- The lid seal guarantees a tight seal during operation.
- User-friendly control panel.
- Pressure gauge with a timer allows you to accurately determine when the required vacuum level is reached in the embossed bag.
- 9 vacuum levels, depending on bag size (no adjustment of vacuum time).
- Bag sealing time countdown.
- Vibration pump.
- Pump capacity: 20 l/min
- Net weight: 8 kg
- The vacuum packaging machine is not dedicated for continuous operation.
- To be used with embossed bag.

code	seal strip (mm)	V	W	mm
970362	350	230	250	370x280x(H)170



975374

VACUUM PACKAGING MACHINE KITCHEN LINE

- For packaging of food and non-food products, excluding liquids.
- Can be used with bag rolls attachment 970638.
- Stainless steel housing.
- The lid seal guarantees a tight seal during operation.
- User-friendly control panel.
- Countdown timer adjustment function: 0-6 s
- With marinate function.
- With pulse vacuum generation mode.
- Quick start buttons for vacuum and sealing on the handle.
- Automatic switch off after 10 minutes of idleness.
- Vibration pump.
- Pump capacity: 16 l/min.
- Net weight: 5 kg.
- The vacuum packaging machine is not dedicated for continuous operation.
- To be used with embossed bag.

code	seal strip (mm)	V	W	mm
975374	410	230	550	490x260x(H)145



970638

BAG ROLLS ATTACHMENT FOR 975374 VACUUM PACKAGING MACHINE KITCHEN LINE

- Can be attached to vacuum packaging machine Kitchen Line 975374 or as a stand-alone attachment for other vacuum packaging machines.
- Equipped with a removable knife to cut exactly the needed bag length.
- Internal dimensions: 412x101x(H)101 mm.
- For rolls with maximum dimensions of Ø 100x400 mm.
- Base made of ABS.
- Transparent polycarbonate cover for easy control of the roll.

code	mm
970638	487x122x(H)107

VACUUM PACKING BAGS



SOUS-VIDE COOKING BAGS FOR VACUUM PACKING MACHINES

- Suitable for sous vide cooking.
- 2-ply, inside layer 60 µm food contact approved Polyethylene, outside layer 15µm Polyamide (Nylon).
- Total thickness is 75 µm.
- The used materials act as a UV filter.
- Bags can be used in temperatures from -20° up to 110°C.
- Suitable for chamber vacuum packing machines.

code	packed per	mm
970676	100	200x150
970652	100	250x150
970683	100	300x200
970669	100	350x250
970690	100	400x300

VACUUM PACKING BAGS, FOR CHAMBER VACUUM PACKING MACHINES

- 2 layers
- Inner layer made from food grade Polyethylene.
- Outer layer made from Polyamide (Nylon) – increases strength and guarantees airtightness
- Total thickness: 65 µm.
- Suitable for chamber vacuum packing machines.
- Not suitable for sous vide cooking.

code	packed per	mm
970607	100	200x140
970386	100	230x160
970614	100	300x200
970393	100	350x250
970621	100	400x300



EMBOSSED VACUUM BAGS ON ROLL - 2 PCS

- 2 layers.
- 60 µm inner layer made from food grade Polyethylene.
- 15 µm outer layer made from Polyamide (nylon) – increases strength and guarantees airtightness.
- Total thickness: 75 µm.
- The materials used act as a UV filter.
- Embossing for easier air extraction and obtaining vacuum.
- Can be used in temperatures from -20° to +100°C.
- Suitable for chamber vacuum and strip packing machines.

code	packed per	mm
971062	2	6000x200
971079	2	6000x280

EMBOSSED VACUUM BAGS

- 2-ply, inside layer 60 µm food contact approved Polyethylene, outside layer 15µm Polyamide (Nylon).
- Total thickness is 75 µm.
- The used materials act as a UV filter.
- Embossing improves the air flow out of the bag during the vacuum packing process.
- Bags can be used in temperatures from -20° up to 100°C.
- Suitable for chamber and external vacuum packing machines.

code	packed per	mm
971048	100	150x400
971017	100	150x250
971024	100	200x300
971055	100	250x350
971031	100	300x400

18/8

stainless steel



237687

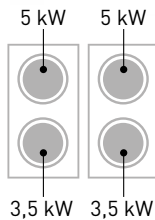

18/8

stainless steel



237670

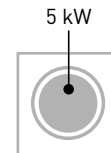

INDUCTION STOVE WITH 4 HOBS

- Designed for professional kitchens to prepare several dishes at the same time.
- Made of durable stainless steel, reinforced with frame.
- 2 separate induction cooktops, 320x560 mm each, made of 5 mm thick tempered glass.
- Equipped with 2 5000 W and 2 3500 W induction burners.
- Up to 60% energy savings when compared to standard electric cookers.
- 4 independent control knobs, 11 power levels to choose from.
- Safe and comfortable working thanks to heat generation only on contact between the hob and the pot or pan.
- Suitable for induction pots and pans with base diameter of $\varnothing 160 - 260$ mm.
- Maximum allowable load for cooktops: 100 kg.
- Adjustable feet (± 30 mm) for perfect leveling of the cooker.
- Rack provides ample storage space for pots, pans or other accessories.
- Unit is not supplied with a plug.
- Caution: the unit has to be connected to the power supply by an electrician.

code	V	W	mm
237687	400	17000	800x700x(H)870

INDUCTION HOKKER HIGH POWER

- Designed for use with woks or extra large induction pots.
- Made of durable stainless steel, reinforced with frame.
- Induction cooktop with 340x340 mm dimensions, made of 5 mm thick tempered glass.
- Up to 60% energy savings when compared to standard electric cookers.
- Convenient control knob, 11 power levels to choose from.
- Safe and comfortable working thanks to heat generation only on contact between the hob and the pot or pan.
- Suitable for induction pots and pans with base diameter of $\varnothing 160 - 300$ mm.
- Maximum allowable load for cooktop: 40 kg.
- Adjustable feet (± 30 mm) for perfect leveling of the cooker.
- Unit is not supplied with a plug.
- Caution: the unit has to be connected to the power supply by an electrician.

code	V	W	mm
237670	400	5000	400x400x(H)380



GAS COOKER KITCHEN LINE WITH CONVECTION ELECTRIC OVEN GN 1/1



- Burners: 2 x 3.5 kW + 2 x 6 kW or 3x 3,5 kW + 3x 6 kW
- Pots: Ø 120-300 mm.
- Cast iron pan support 335x300 mm, one for each burner.
- Thermocouple.
- Cooker top: AISI 304.
- Housing: AISI 430.
- Adjustable steel feet.

CONVECTION OVEN GN 1/1:

- Electric 3 kW/230 V.
- Stainless steel chamber: 640x370x(H)350 mm
4 rail pairs for GN 1/1.
- Distance between rails: 75 mm.
- 1 GN 1/1 grid included.
- Thermostat.

cast iron grates 335x300 mm,
separate for each burner

for ø120-300 mm pots

countertop: AISI 304,
housing: AISI 430

electric oven GN 1/1

adjustable steel feet
100-165 mm



839997

PAN SUPPORT ADAPTER

- For placing small pans on large pan supports.

code	mm
839997	255x255x(H)25

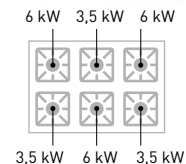
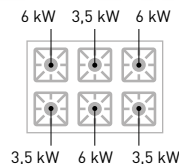
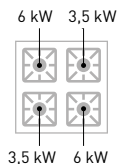
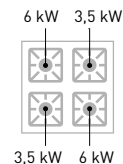

code	227381	225882	226094	225899
dimensions	800x700x(H)310 mm	800x700x(H)900 mm	1200x700x(H)900 mm	1200x700x(H)900 mm
oven dimensions	-	640x370x(H)350 mm	-	640x370x(H)350 mm
burner power	2x 3,5 kW + 2x 6 kW	2x 3,5 kW + 2x 6 kW	3x3,5 kW + 3x6 kW	3x3,5 kW + 3x6 kW
type of oven	-	convection, electric	-	convection, electric
oven power	-	3 kW	-	3 kW
total power	19 kW [HS]	19 kW [HS]	28,5 kW [HS]	28,5 kW [HS]
voltage	-	230 V	-	230 V
weight	35 kg	82 kg	95 kg	105 kg



225806

GAS COOKER - 5 BURNERS, OPEN FRAME

- Suitable for natural gas.
- 3 burners of 3.0 kW.
- 1 small burner of 1.8 kW.
- 1 wok burner of 3.5 kW.
- With electronic ignition and thermocouples.
- Three-part cast iron pan support.
- Weight: 45 kg.

code	kW(HS)	mm
225806	14.3	900x600x(H)850



225707

GAS COOKER - 5 BURNERS WITH ELECTRIC OVEN

- Suitable for natural gas.
- 3 burners of 3.0 kW.
- 1 small burner of 1.8 kW.
- 1 wok burner of 3.5 kW.
- Piezo ignition and thermocouple.
- Three-part cast iron pan support.
- Convection oven 1/1 GN with a capacity of 2.7 kW fitted with two ventilators, thermostat to 275°C and timer.
- Includes 2 grids.
- Additional upper element of 2.5 kW for grilling.
- Stainless steel oven interior and inner door.
- Weight: 78 kg.

code	V	W	kW(HS)	mm
225707	230	2900	14.3	900x655x(H)900



626504

147207

147306

WOK

- With handles, sheet steel 1.5 mm thick.
- Especially suitable for stainless steel wok holder 149546 with Green Fire barbecues, and in combination with stainless steel ring 147207 and Hokker 147108.



code	mm
626504	ø710x(H)220

RING FOR HOKKER

- To adapt Hokker 147108 to use with wok 626504.



code	mm
147207	ø360x(H)80

HOKKER STAND

- Only suitable for Hokker Big Flame: 147108.



code	mm
147306	425x425x(H)400



147801

HOKKER KITCHEN LINE

- Model Kitchen Line - for propane and butane gas.
- Including converter set also suitable for natural gas.
- Fully stainless steel frame.
- Fitted with thermocouple and electronic ignition.
- Fitted with enamelled pan support.
- Gas hose and pressure regulator included.

code	kW[HS]	mm
147801	6	400x440x(H)390



147276

HOKKER KITCHEN LINE XL

- XL model - for propane and butane gas.
- Converter set included to make it also suitable for natural gas.
- Fitted with an extra large enamelled pan support.
- Frame completely out of stainless steel.
- Fitted with thermocouple and electronic ignition.
- Gas hose and pressure regulator included.

code	kW[HS]	mm
147276	10.8	580x650x(H)400



147108

HOKKER PROFI LINE

- For propane and butane gas.
- Very robust stainless steel frame to carry heavy loads.
- Fitted with thermocouple and electronic ignition.
- Fitted with cast iron pan carrier.
- Gas hose and pressure regulator included.
- Can be expanded with hokker base (147306), wok ring (147207) and wok (626504).

code	kW[HS]	mm
147108	6.7	425x425x(H)400

NEW



152157

PRESSURE REGULATOR 50 MBAR

- For HENDI gas barbecues & Hokkers.

code
152157

NEW



147139

GAS HOSE ASSEMBLY HOKKERS

- For HENDI Hokker Profi & Kitchen Line 147108 147801.

code
147139

INDUCTION COOKERS KITCHEN LINE



- Very clean design suitable for live cooking.
- Very flat housing with black coated stainless steel frame.
- Surface of ceramic glass with integrated digital display.

THERMAL PROCESSING



 min Ø120 mm
 max Ø230 mm
 2000 W
 230 V

239391



 min Ø140 mm
 max Ø280 mm
 3500 W
 230 V

239421

INDUCTION COOKER 2000W KITCHEN LINE

- Touch-sensitive controls, power or temperature adjustable in 11 steps.
- Temperature range: 35-240°C.
- Suitable for pans with bottom diameter between 120 and 220 mm.
- With timer function for 0-180 minutes.
- Equipped with electronic protection against overheating.
- Maximum load of the induction cooker: 15 kg.

INDUCTION COOKER 3500W KITCHEN LINE

- Touch-sensitive controls, power or temperature adjustable in 10 steps.
- Temperature range: 35-240°C.
- Suitable for pans with bottom diameter between 140 and 280 mm.
- With timer function for 0-180 minutes.
- Equipped with electronic protection against overheating.
- Maximum load of the induction cooker: 20 kg.

code	V	W	mm
239391	230	2000	293x373x(H)56

code	V	W	mm
239421	230	3500	337x417x(H)85



Sturdy stainless steel frame

High quality ventilation

Touch-sensitive controls



 min Ø120 mm
max Ø230 mm

3500 W
230 V

239414



Works also with
a GN tray up to GN 1/2

800 W
230 V

239384

DOUBLE INDUCTION COOKER KITCHEN LINE

- Touch-sensitive controls, power or temperature adjustable in 9 steps.
- With boost mode which temporarily shifts some power from right hob to the left hob, providing up to 2000W
- The left side hob can output 1800W, or 2000W while the boost function is active
- The right side hob can output 1700W
- Temperature range: 35-240°C
- Suitable for pans with bottom diameter between 120 and 220 mm
- With timer function for 0-180 minutes
- Equipped with electronic protection against overheating
- Maximum load of the induction cooker: 2x15 kg

code	V	W	mm
239414	230	3500	608x370x(H)61

INDUCTION HOT PLATE KITCHEN LINE

- Unique induction hot plate with a rectangular induction coil which keeps pans warm while providing freedom of placement.
- Power adjustable in 11 steps by means of a knob.
- Temperature range: 40-100°C.
- Equipped with electronic protection against overheating.
- Maximum load of the induction cooker: 15 kg.



code	V	W	mm
239384	230	800	460x315x(H)62





239780

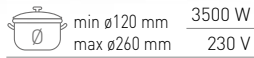

3500 W
230 V

INDUCTION COOKER MODEL 3500 M

- Steplessly adjustable power dial.
- Stainless steel housing.
- Maximum load of the induction cooker: 20 kg.
- Suitable for pans with bottom diameter between 120 and 260 mm.

code	V	W	mm
239780	230	3500	327x425x(H)100



239711

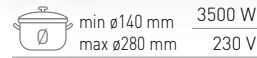

3500 W
230 V

INDUCTION COOKER MODEL 3500 D

- Digital power, temperature and timer setting via touch-sensitive controls.
- Stainless steel housing.
- With easily cleanable grease filter and double ventilation.
- Suitable for pans with bottom diameter between 140 and 280 mm.
- Height adjustable feet.
- Maximum load of the induction cooker: 20 kg.

code	V	W	mm
239711	230	3500	340x440x(H)120



239698

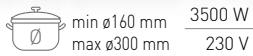

3500 W
230 V

INDUCTION COOKER MODEL 3500 D XL

- Digital power, temperature and timer setting via touch-sensitive controls
- Stainless steel housing
- With easily cleanable grease filter and double ventilation
- Suitable for pans with bottom diameter between 160 and 300 mm
- Height adjustable feet
- Maximum load of the induction cooker: 20 kg

code	V	W	mm
239698	230	3500	390x500x(H)120



239766

3500 W
230 V

INDUCTION WOK MODEL 3500

- Ideal for preparing nutritious meals.
- Stainless steel housing.
- With easily cleanable grease filter.
- Digital power setting.
- Settings immediately respond to high-low.
- Only suitable for use with wok pan 239773.
- Maximum load of the induction cooker: 20 kg.

code	-	V	W	mm
239766	induction unit	230	3500	340x450x(H)120
239681	induction wok+wok pan	230	3500	340x450



 min ø140 mm 5000 W
max ø280 mm 400 V

239322



 min ø140 mm 5000 & 3500 W
max ø280 mm 400 V

239346

INDUCTION COOKER MODEL 5000 D

- Digital power, temperature and timer setting via touch-sensitive controls.
- Stainless steel housing.
- With easily cleanable grease filter and double ventilation.
- Suitable for pans with bottom diameter between 140 and 280 mm.
- Height adjustable feet.
- Works on 380 V, supplied without plug, an electrician is required for the installation.
- Maximum load of the induction cooker: 30 kg.

code	V	W	mm
239322	400	5000	398x515x(H)168

INDUCTION COOKER MODEL 7000

- Stainless steel housing with two hobs.
- Front hob has a maximum power of 5000 W, when the front hob operates at 5000 W the rear hob can only generate 2000 W.
- Rear hob has a maximum power of 3500 W only while the front hob doesn't exceed 3500 W.
- Electronic protection against overheating.
- With adjustable metal feet and removable air filter.
- Works on 380 V, supplied without plug, an electrician is required for the installation.
- Suitable for pans with bottom diameter between 140 and 280 mm.
- Maximum load of the induction cooker: 20+20 kg.

code	V	W	mm
239346	400	7000	405x698x(H)145



239681



239773

WOK

- 3-ply material.
- With stainless steel handle with softgrip.
- With stainless steel lid.
- Specifically for use with 239766.

code	mm
239773	ø360x(H)180





S.S.
stainless steel

INDUCTION COOKER MODEL 2000

- Very slim housing (32 mm) with stainless steel frame.
- Ceramic glass surface.
- Touch-sensitive control.
- Maximum load of the induction cooker: 15 kg.
- Suitable for pans with bottom diameter between 120 and 260 mm.



239230



min ø120 mm
max ø260 mm

2000 W
230 V

code	V	W	mm
239230	230	2000	296x370x(H)46



239209



min ø120 mm
max ø260 mm

1800 W
230 V

INDUCTION COOKER MODEL 1800

- ABS housing.
- Digital power, temperature and timer setting.
- Settings immediately respond to high-low.
- Maximum load of the induction cooker: 15 kg.
- Suitable for pans with bottom diameter between 120 and 260 mm.

ABS
plastic

code	V	W	mm
239209	230	1800	315x345x(H)70



209509

HOT TRAY

- GN 1/1 - aluminium.
- On insulated base.
- Automatically heats itself to 95°C.
- Can be used in combination with Thermobox Kitchen Line GN 1/1 and bigger (707906, 707968, 707951, 707944)

AL
aluminium

code	V	W	mm
209509	230	190	530x325x(H)30



239193



INDUCTION HEATER 800W

- Black crystal glass top surface and plastic housing.
- Power regulation adjustable in 10 steps, fitted with electronic overheating protection.
- Control panel with LED display and touch control, can be mounted in a countersunk manner.
- Can be used as a heater chafing dishes equipped with special adapter.
- Also suitable for built-in installation with the optional separately available ring (239186).

code	V	W	mm
239193	230	800	ø245x(H)68



239186

MOUNTING FRAME FOR INDUCTION HEATER, 800W

- Suitable for induction heater 239193.

code	mm
239186	ø270x(H)17



239551

BUILT-IN INDUCTION HEATER, 1000 W

- Heating surface made of black crystal glass.
- Plastic housing.
- Induction heater for countertop installation.
- 10-step power adjustment.
- Equipped with electronic overheating protection.
- Touch panel and LED display.
- Maximum allowable load for the stove: 15 kg.
- Suitable for pots and pans with base diameter of ø120-200 mm.

code	V	W	mm
239551	230	1000	350x350

Two quartz heaters

Under-shelf
lightingS.S.
stainless steel

233962

QUARTZ HEATED COUNTERTOP DISPLAY

- Stainless steel housing, tempered glass sides, curved acrylic glass doors and mirror back panel.
- Two levels.
- Access via two curved glass doors at the front.
- The shelves fit up to 4 GN 1/2 containers (GN containers not included).
- Fitted with 2 quartz heating elements and an electric heating plate at the bottom.
- With mechanical temperature control.
- Light at the top of the chamber.
- Temperature range: 30°-90°C.

code	V	W	mm
233962	230	560	650x467x(H)630



233726



233733

Cr
chrome platedS.S.
stainless steel**HEATED COUNTERTOP DISPLAY**

- Fitted with double glazing and curved front glass.
- Three levels.
- Two sliding doors at the back.
- Made of stainless steel.
- LED light at the top of the chamber.
- With 3 chrome-plated adjustable shelves.
- Temperature control knob and analogue thermometer.
- Temperature range: 30°-90°C.

code	-	V	W	mm
233726	120 Liter	230	1100	678x568x(H)686
233733	160 Liter	230	1500	857x568x(H)686

LED lighting

sliding doors





273982



273999

HEATED COUNTERTOP DISPLAY

- Stainless steel housing.
- Tempered glass sides, curved front glass.
- One level.
- Large glass door in the rear, full access to the inside.
- Easy to clean.
- With removable crumb tray.
- Temperature control up to 85 °C.
- Includes fine mesh GN 1/1 grid suitable for small products.



code	-	V	W	mm
273982	single level	230	400	554x376x(H)311

HEATED COUNTERTOP DISPLAY

- Stainless steel housing.
- Tempered glass sides, curved front glass.
- Two levels.
- Large glass door in the rear, full access to the inside.
- Easy to clean.
- With removable crumb tray.
- Temperature control up to 85 °C.
- Includes 2 fine mesh GN 1/1 grids suitable for small products.



code	-	V	W	mm
273999	double level	230	400	554x376x(H)432



Water container for humidification

HEATED COUNTERTOP CABINET

- Fitted with door at the back and curved front glass.
- Lightbox with room for promotional graphics.
- Stainless steel housing.
- Internal lighting in the ceiling.
- With 3 chrome plated shelves, adjustable in height 400x335 mm.
- Water container for air humidification in the heating cabinet.
- Temperature controller and display.
- Temperature range: 30°C up to 90°C.



code	-	V	W	mm
233740	97 Liter	230	800	460x448x(H)785



233740



7 trays
500 W
230 V



229064

KITCHEN LINE FOOD DEHYDRATOR

- Double wall polypropylene casing increases thermal efficiency.
- The automatic fan circulates the warm air inside the chamber ensuring an even dehydration without the necessity to turn the trays.
- The set includes 7 305x330 mm stainless steel grates, each with a max load of 500 g.
- Grates are evenly interspaced at 35 mm, easy to remove and clean.
- Transparent door allows the operator to observe the dehydration process.

- It comes with a transparent pad to prevent smaller fruit from falling during dehydration process – it can be also placed at the bottom of the dehydration chamber to collect residue.
- Digital display.
- Temperature control: 35°-70°C.
- Timer adjustable up to 24 hours, in 30-minute intervals.

code	-	V	W	mm
229064	7 trays	230	500	345x450x(H)315

Easy controls.



With fine mesh for drying small items.



PLASTIC DRIPTRAY FOR FOOD DEHYDRATORS

- For use with HENDI food dehydrators 229002 229019 229033 229064.

code
941461



NEW

941461

FOOD DEHYDRATOR PROFI LINE

- Stainless steel housing.
- Digital control panel.
- Timer adjustable up to 24 hours, in 30-minute intervals.
- Temperature control: 35°-75°C, adjustable in 5°C increments.
- The quiet fan circulates the warm air inside the chamber ensuring an even dehydration without the necessity to turn the trays.
- The set includes 6 305x330 mm stainless steel grates.
- Grates are evenly interspaced, easy to remove and clean.
- Transparent door allows the operator to observe the dehydration process.

code	-	V	W	mm
229033	6 trays	230	650	340x450x(H)311



Watch the video

PROFI LINE FOOD DEHYDRATOR

- Stainless steel housing.
- Digital control panel.
- Timer adjustable up to 24 hours, in 30-minute intervals.
- Temperature control: 35°-75°C, adjustable in 5°C increments.
- The quiet fan circulates the warm air inside the chamber ensuring an even dehydration without the necessity to turn the trays.
- The set includes 10 395x380 mm stainless steel grates.
- Grates are evenly interspaced, easy to remove and clean.
- Transparent door allows the operator to observe the dehydration process.

code	-	V	W	mm
229026	10 trays	230	1000	417x535x(H)430

DRIPTRAY FOR FOOD DEHYDRATOR

- For HENDI Profi Line Food dehydrator 229026

NEW

code
946190

SPICE MAT FOR FOOD DEHYDRATOR

- For HENDI food dehydrator Profi Line 229026

NEW

code
946268

6 trays
600 W
230 V



229033

10 trays
1000 W
230 V



229026



946190

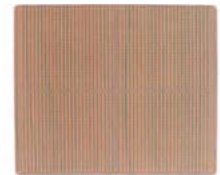

946268



Residu pad included



Easy to operate digital control panel



Drying chamber with space for 10 trays

Foldable
doughnut rack

205914



Thanks to the "cold zone"
frying residues are collected
below the heater, increasing
the quality of the oil.

Drain tap

DOUGHNUT DEEP FRYER

- The appliance is ideal for frying donuts, angel wings and various other dishes that are fried in deep fat.
- Designed for intensive use.
- Entirely Made of stainless steel.
- Large oil tank 400x400x(H)160 mm with a max. capacity of 12 liters.
- Welded oil tank with equipped with drain tap at the bottom.
- Removable control element with heater, with an additional safety feature that switches off the entire unit when removed.
- Temperature control: 50°-190°C.
- Overheating protection with reset function for better safety.
- "Cold zone" system separates frying residue below the heater level, increasing fat yield and preventing the fries from getting burnt.
- Rubber, non-slip feet.

code	liters	V	W	mm
205914	12	230	3500	630x860x(H)360



DEEP FRYERS PROFI LINE

- Profi Line deep fryers are made of 18/0 stainless steel.
- Removable control element with an additional safety feature that switches off the fryer heater when it is removed.
- The grease container has a V-shaped bottom with an optimal "cold zone" for increased grease yield.
- Easy to read control panel with temperature control knob and indicator light.
- Overheating protection thanks to a resettable thermal fuse.
- Deep frying basket with extra-long, cool-touch handle for intensive use.
- All deep fryers are equipped with 1 deep frying basket and 1 lid for each chamber.

18/0
stainless steel

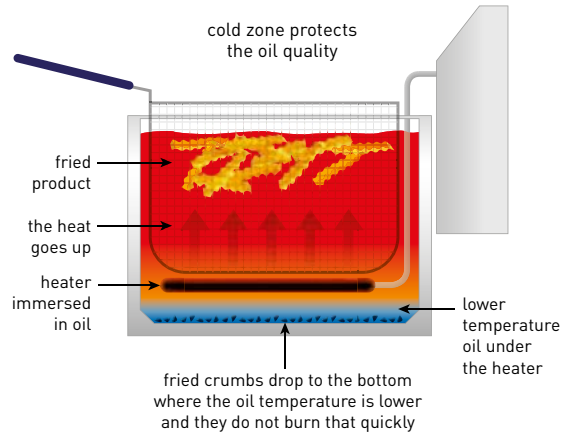

DEEP FRYER XL PROFI LINE WITH DRAIN TAP, 10 L, 400 V

- Very powerful 400V deep fryer, allows the heating element to use up to 6600W of power.
- Reduces the temperature recovery time after inserting frozen food, resulting in crispier food.
- Supplied without plug, an electrician is required for the installation.

code	liters	V	W	mm
209424	10	400	6600	302x687x(H)375



XL
10 L

FRYING BASKET

code	
930618	4 litre deep fryers 205808 205846
930632	6 liter friteuses 205815 205853
930656	8 liter deep fryer 205822 205839
933664	8 liter deep fryer 207208 207307 209202 209301
944387	Induction deep fryers 215012 215029
961247	10 liter deep fryer 209424





DEEP FRYERS PROFI LINE DIGITAL

- The Profi Line range of tabletop deep fryers is made of 18/0 stainless steel.
- Element with switch-off function when removed.
- Oil tank with a V-shaped bottom ensures an optimal cold zone, increases the useful life of the oil.
- Clear digital control panel with temperature and timer function.
- Protected against overheating by means of a re-settable thermal fuse.
- A frying basket with extra long handle turns this model into a fine piece of equipment for intensive use.
- All deep fryers come with frying basket(s) and lid(s).

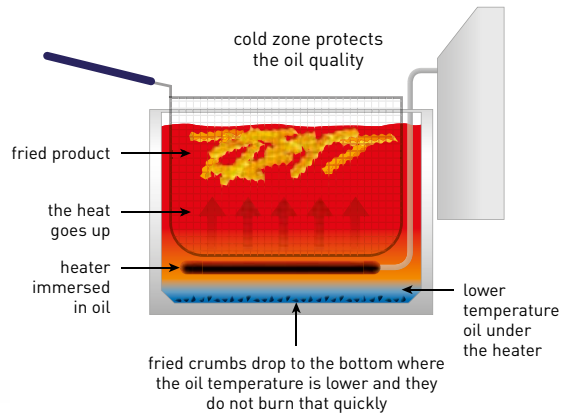

18/0
stainless steel



Frying baskets
at page 165

8 l
3500 W
230 V



207369

2x 8 l
2x 3500 W
230 V



207376

DEEP FRYER PROFI LINE WITH DRAIN TAP DIGITAL - 8 L

- Clear digital control panel with temperature and timer function.

code	liters	V	W	mm
207369	8	230	3500	300x515x(H)345

DEEP FRYER PROFI LINE WITH DRAIN TAP DIGITAL - 2 X 8 L

- Clear digital control panel with temperature and timer function.

code	liters	V	W	mm
207376	16	230	7000	605x515x(H)345

DEEP FRYERS PROFI LINE

- Profi Line deep fryers are made of 18/0 stainless steel.
- Removable control element with an additional safety feature that switches off the fryer heater when it is removed.
- The grease container has a V-shaped bottom with an optimal "cold zone" for increased grease yield.
- Easy to read control panel with temperature control knob and indicator light.
- Overheating protection thanks to a resettable thermal fuse.
- Deep frying basket with extra-long, cool-touch handle for intensive use.
- All deep fryers are equipped with 1 deep frying basket and 1 lid for each chamber.

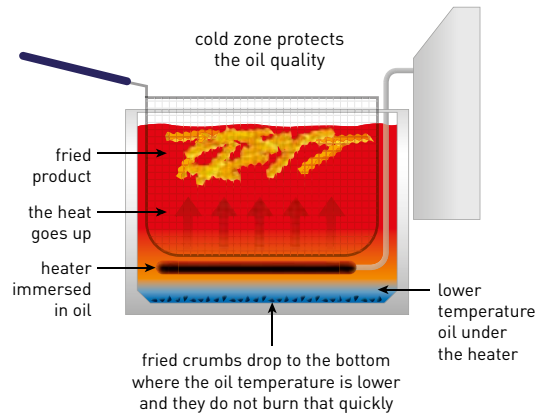

207208



207307

18/0
stainless steel

DEEP FRYER PROFI LINE, 8 L

code	liters	V	W	mm
207208	8	230	3500	305x460x(H)350

DEEP FRYER PROFI LINE, 2 x 8 L

code	liters	V	W	mm
207307	16	230	7000	605x460x(H)350



209202



209301

DEEP FRYER PROFI LINE WITH DRAIN TAP, 8 L

code	liters	V	W	mm
209202	8	230	3500	305x515x(H)350

DEEP FRYER PROFI LINE WITH DRAIN TAP, 2 x 8 L

code	liters	V	W	mm
209301	16	230	3500	605x515x(H)350



18/0
stainless steel



205808



205839

DEEP FRYER KITCHEN LINE

- Housing and oil tank made of stainless steel.
- Removable element with switch-off function when removed.
- Removable oil container, making it easier to clean.
- Heating indication lamp to show if the heating element is operating.
- The temperature can be set up to 190°C.
- A security thermostat ensures the deep fryer does not overheat.
- Overheat protection with reset for extra protection.
- A frying basket with heat insulated and extra long handle.
- Cold zone to protect oil quality.
- Supplied with frying basket and lid.

Frying baskets
at page 165

code	liter	V	W	mm
205808	4	230	3000	217x380x(H)300
205846	4+4	230	3000+3000	470x420x(H)330
205815	6	230	3300	265x430x(H)290
205853	6+6	230	3300+3300	550x430x(H)290
205822	8	230	3500	265x430x(H)345
205839	8+8	230	3500+3500	550x430x(H)345

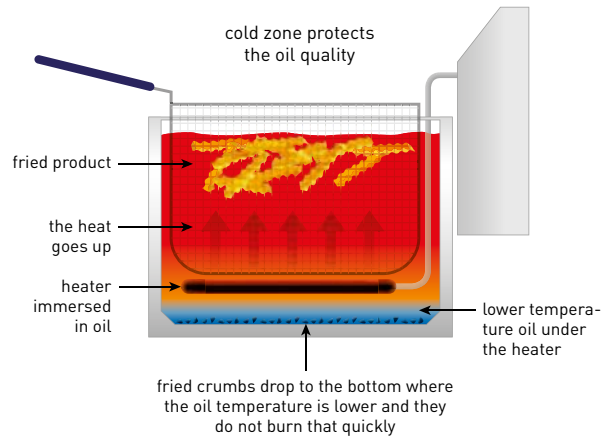

8 l
3500 W
230 V



215012

INDUCTION DEEP FRYER WITH DRAIN TAP

- Precise temperature control - thanks to induction, the set oil temperature is maintained.
- Timer.
- Efficient heat exchange.
- Stainless steel housing for easy cleaning.
- Overheating protection.
- Control panel with display shows the set oil temperature.
- Supplied with a frying basket, a lid and an oil filter.

2x 8 l
2x 3500 W
230 V



215029

Frying baskets
at page 165

INDUCTION DEEP FRYER WITH DRAIN TAP, 8 L

code	liters	V	W	mm
215012	8	230	3500	290x485x(H)405

INDUCTION DEEP FRYER WITH DRAIN TAP - 2 X 8 L

code	liters	V	W	mm
215029	16	230	7000	580x485x(H)406

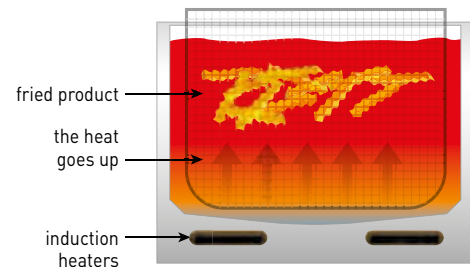

Drain tap makes
emptying easy



With filter for the
induction motor



Convenient edge
for hanging basket





RISE AND FALL HEAT LAMP CONICAL



- Thanks to the adjustable cord this heat lamp is very flexible, the length of the cord is adjustable from 70 to 150 cm.
- The amount of heat provided can be changed by adjusting the length of the cord.
- On/off switch located on top of the lamp.
- The included light bulb is shatterproof, making it suitable for keeping food warm.

code	colour	V	W	mm
273845	Black	230	250	ø275x(H)250
273869	Silver	230	250	ø275x(H)250
273876	Copper	230	250	ø275x(H)250

RISE AND FALL HEAT LAMP CYLINDRICAL



- Thanks to the adjustable cord this heat lamp is very flexible, the length of the cord is adjustable from 70 to 150 cm.
- The amount of heat provided can be changed by adjusting the length of the cord.
- On/off switch located on top of the lamp.
- The included light bulb is shatterproof, making it suitable for keeping food warm.

code	colour	V	W	mm
273883	Silver	230	250	ø175x(H)250
273890	Copper	230	250	ø175x(H)250
273852	Black	230	250	ø175x(H)250

INFRARED HEAT BULB

- Infrared replacement bulb for heat lamps.
- Ideal for back of house use, emits warm red light.
- Shatterproof, with normal fitting [E27].

code	V	W	mm
919217	230	250	ø125x(H)170



919217



919200

INFRARED HEAT BULB

- Infrared replacement bulb for heat lamps.
- Ideal for front of house use, emits bright white light.
- Shatterproof, with normal fitting [E27].

code	V	W	mm
919200	230	250	ø125x(H)170



2 LAMP INFRARED FOOD WARMER BRIDGE

- Designed to keep food warm between preparing and serving.
- Height is easily adjustable between 590 and 790 mm.
- Shatterproof lamps included.

code	colour	V	W	mm
273906	Silver	230	500	453x360x(H)790
273913	Black	230	500	453x360x(H)790



GRIDDLES PROFI LINE

- Stainless steel housing.
- The hard chromed surface (9mm plate) facilitates cleaning.
- With removable dripping tray and high backsplashes.
- Stepless thermostat adjustable up to 300°C.
- Overheating protection.
- Suitable for continuous use.
- Power switch with integrated indication lamp.
- Non-slip feet.

Scrapers & turners
on page 83

GRIDDLE

- Griddle area 330x270 mm, entirely smooth.

code	-	V	W	mm
203125	smooth	230	2000	300x420x(H)225

203125



203149

GRIDDLE

- Griddle area 518x328 mm, entirely smooth.

code	-	V	W	mm
203149	flat	230	2400	550x420x(H)240



203156

GRIDDLE HALF RIBBED

- Grill surface: 518x328 mm, left 259 mm smooth and right 259 mm ribbed.

code	-	V	W	mm
203156	1/2 flat, 1/2 ribbed	230	2400	550x380x(H)240



203170

GRIDDLE RIBBED

- Griddle area 518x328 mm, entirely ribbed.

code	-	V	W	mm
203170	entirely ribbed	230	2400	550x420x(H)240



203163

GRIDDLE 1/3 RIBBED

- 2 independent working areas, 2 heating indication lamps.
- Griddle area 688x410 mm, left 462 mm smooth and right 226 mm ribbed.

code	-	V	W	mm
203163	2/3 flat, 1/3 ribbed	230	3500	720x530x(H)250



CONTACT GRILLS



- Perfect for grilling and heating bread, pieces of meat, sausages, vegetables, etc.
- Enameled cast iron griddles, easy to clean and maintain.
- Housing made from 18/10 stainless steel guarantees durability.
- High power heating elements quickly heat up the grills.
- Temperature can be set continuously, using the thermostat, from 0 °C to 300 °C.
- Ventilation openings protect the grill against overheating.

- Bottom grill fitted with rear and side edges and a removable dripping tray, making cleaning easier.
- Lift the top grill with the heat resistant handle and lock in any position thanks to the spring-loaded mechanism.
- Fitted with mains switch with integrated indicator light, pre-heating light and 1.7 m power cable with earthed plug.
- With rubber feet, reducing accidental movement during use.
- Grill cleaning brush is included in the kit.

Convenient hand grip

Heating surface made of cast iron with ceramic coating



Watch the video



Fat and drip tray

Thermostat with smooth temperature control

CONTACT GRILL - SINGLE VERSION

- Grill surface: 220x230 mm.
- Ribbed.

code	V	W	mm
263501	230	1800	310x370x(H)210

CONTACT GRILL - SINGLE VERSION

- Grill surface: 220x230 mm.
- 1/2 ribbed and 1/2 smooth.

code	V	W	mm
263600	230	1800	310x370x(H)210

1800 W
230 V



263501



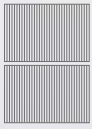

CONTACT GRILL „PANINI”

- Grill surface: 340x230 mm.
- Ribbed.

code	V	W	mm
263655	230	2200	430x370x(H)210

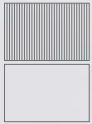

CONTACT GRILL „PANINI”

- Grill surface: 340x230 mm.
- 1/2 ribbed and 1/2 smooth.

code	V	W	mm
263662	230	2200	430x370x(H)210

263655

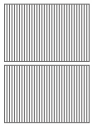

XL
→ | 545 mm | ←

CONTACT GRILL „PANINI” XL

- Both the top and bottom grill are grooved.

code	V	W	mm
263624	230	2700	548x415x(H)210

3000 W
230 V

263624

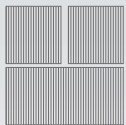

CONTACT GRILL - DOUBLE GRILL

- Thermostats independently adjustable.
- Grill surface bottom plate 475x230 mm.
- Entirely ribbed.

code	V	W	mm
263709	230	3600	570x370x(H)210

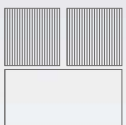

CONTACT GRILL - DOUBLE VERSION

- Thermostats independently adjustable.
- Grill surface bottom plate 475x230 mm.
- 1/2 ribbed and 1/2 smooth.

code	V	W	mm
263808	230	3600	570x370x(H)210

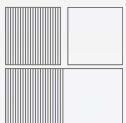

CONTACT GRILL - DOUBLE VERSION

- Thermostats independently adjustable.
- Grill surface bottom plate 475x230 mm.
- 1/2 smooth, 1/2 ribbed.

code	V	W	mm
263907	230	3600	570x370x(H)210

263709

3600 W
230 V





Motor can rotate both ways

Equipped with 4 burners

Removable dripping tray

Wide reflection screens



226001

KEBAB GRILL GAS PROFI LINE

- For natural gas, can be converted to propane with included converter set.
- Fitted with thermocouple.
- Grill distance adjustment.
- Burners power 12 kW.
- Delivered with reflection screens.
- Grill length: 900 mm.
- Capacity: up to 80 kg.
- Weight 30 kg.

code	kW[HS]	mm
226001	12	470x550x(H)1150

18/0
stainless steel

KEBAB KNIFE ELECTRIC

- For slicing döner kebab, shawarma, gyro, etc.
- 2 stainless steel Ø 100 mm blades, 1 smooth and 1 serrated.
- Blade spins at 2600 RPM and can slice up to 60 kg/h.
- Easily adjustable slicing thickness from 0 mm up to 8 mm.
- Blade cover made of stainless steel ensures safety during cutting.
- Handle and motor housing made of anti-slip material.
- ON/OFF switch integrated with the housing.
- Overload protection with a reset button.
- Blade sharpening stone included.
- Weight 1 kg.

code	V	W	mm
267240	230	80	202x152x(H)182



267240

Al S.S.
aluminium stainless steel

CORDLESS KEBAB KNIFE ELECTRIC

- For slicing döner kebab, shawarma, gyro, etc.
- 2 stainless steel Ø 100 mm blades, 1 smooth and 1 serrated.
- Blade spins at 2600 RPM and can slice up to 60 kg/h.
- Easily adjustable slicing thickness from 0 mm up to 8 mm.
- Blade cover made of stainless steel ensures safety during cutting.
- Handle and motor housing made of anti-slip material.
- ON/OFF switch integrated with the housing.
- Charger with red and green light indicating battery level.
- Two 2,000 mAh battery packs included.
- Blade sharpening stone included.
- Weight 1,3 kg.

code	V	W	mm
267257	230	80	199x152x(H)184



267257

REPLACEMENT KNIFE FOR KEBAB KNIFES

- Replace your broken or lost knife to extend the service life of your electric kebab knife.
- For use with HENDI Kebab knife electric 267240 & 267257.

code
267219

KEBAB KNIFE ELECTRIC

- Ideal for slicing any type of roasted meat like; kebab, shoarma, gyros, etc.
- Large Ø 80 mm smooth slicing disk with stainless steel guard.
- The blade cover ensures safety while slicing.
- Additional Ø 80 mm serrated slicing disk included.
- Disk spins at 8.000 RPM.
- Aluminium handle with 2.7 m power cord.
- Ingress protection: IPX4.
- Adapter with indicator lamp.
- Blade sharpening stone, knife stand and a screwdriver are included.

code	V	W	mm
267264	230	80	232x120x(H)115



267264



SOUS-VIDE SYSTEM

- Culinary system in which vacuum-sealed food is cooked at a precisely controlled temperature.
- Ideal for à la carte restaurants.
- Exceptionally suitable for preparation outside peak times.

- Consistently high quality results.
- High precision thermostat adjustable (0,1°C) from 35° to 90°C.
- Housing made entirely of stainless steel.
- Can be sealed air- and watertight due to the lid with silicone rim.



GN 1/1
600 W
230 V

225448



GN 2/3
400 W
230 V

225264

SOUS-VIDE SYSTEM GN 1/1

- Equipped with handles and drain tap.
- Stainless steel spacer with 6 compartments included.

code	liters	V	W	mm
225448	20	230	600	540x335x(H)310

SOUS-VIDE SYSTEM GN 2/3

- With handles.
- Supplied with a spacer with 4 stainless steel compartments.

code	liters	V	W	mm
225264	13	230	400	363x335x(H)290



EMBOSSED VACUUM BAGS

code	packed per	mm
971048	100	150x400
971017	100	150x250
971024	100	200x300
971055	100	250x350
971031	100	300x400



222645



IVIDE CIRCULATOR STICK FOR SOUS-VIDE 2.0 COOKING

- For safety the sous vide stick turns off when removed from the water bath.
- WiFi control possible, app available for iOS and Android devices.
- The app helps users calculate the perfect time and temperature, pre-loaded with over 600 recipes.
- Temperature can be set between 5°C and 90°C in 0,1°C increments.
- Can heat and circulate up to 30 liters of water.
- Can circulate 12 liters of water per minute.
- Bright screen shows the working temperature and time, easy to operate.
- The whole body is IPX7 (submersion) water resistant.

code	V	W	mm
222645	230	1200	63x97x(H)344



864210



LID FOR GN CONTAINERS WITH SOUS VIDE STICK RECESS

- With recess for sous vide stick 222645.
- Also suitable for stainless steel Profi Line Gastronorm containers.

code	GN	mm
864210	GN 1/2	265x325
864203	GN 1/1	530x325





222997

IVIDE PLUS SOUS VIDE THERMAL CIRCULATOR

- High precision sous vide thermal circulator with temperature control.
- 4 inch Touch Screen interface.
- Designed to fit to any round or flat cooking vessel with a minimum depth of 16.5 cm by means of a clamp.
- Best performances up to 80 litres.
- Working temperature 5°C to 99°C, accuracy 0.07°C.
- Timer can be set between 1 minute and 99 hours.
- Multiple Machines can be managed from the app.
- Offers exceptional temperature stability.
- Low level water protection device switches off the sous vide in case of accidental use without water.
- Circulating pump to eliminate cold and hot spots.
- Temperature sensor to prevent overload and overheating.
- Carry Case as Standard.
- IPX7, can withstand splashes and accidental submersion.

App:

- Precise temperature control from anywhere.
- A collection of over 600 recipes.
- Our Sous Vide Calculator: We've done all the testing and research for you, which means no more scouring the internet for information.
- Recipe Memory: Store your own times and temperatures.
- Cook history: For greater HACCP control store your last cook 10 times and temperatures.
- Multi device cooking: Control Several cookers from one app.
- Notifications to confirm when the water is at temperature, and the food is cooked.
- Cook time complete, don't worry the app will keep the food at the optimum temperature for holding.

code	V	W	mm
222997	230	2200	130x145x(H)330



864234

864227



LID FOR GN CONTAINERS WITH SOUS VIDE STICK RECESS

- With recess for sous vide stick 222997.
- Also suitable for stainless steel Profi Line Gastronorm containers.

code	GN	mm
864234	GN 1/2	265x325
864227	GN 1/1	530x325



222638



IVIDE PLUS JUNIOR

- High precision sous vide thermal circulator with temperature control.
- 4 Inch high resolution touch screen interface.
- Designed to fit to any round or flat cooking vessel with a minimum depth of 16.5 cm by means of a clamp.
- Best performances up to 45 litres.
- Working temperature 5°C to 99°C, accuracy 0.07°C.
- Timer can be set between 1 minute and 99 hours.
- WiFi enabled, can be controlled by the sousvidetools app.
- Multiple Machines can be managed from the App.
- Low level water protection device switches off the sous vide in case of accidental use without water.
- Circulating pump to eliminate cold and hot spots.
- IPX7, can withstand splashes and accidental submersion.

code	V	W	mm
222638	230	1500	159x121x(H)285

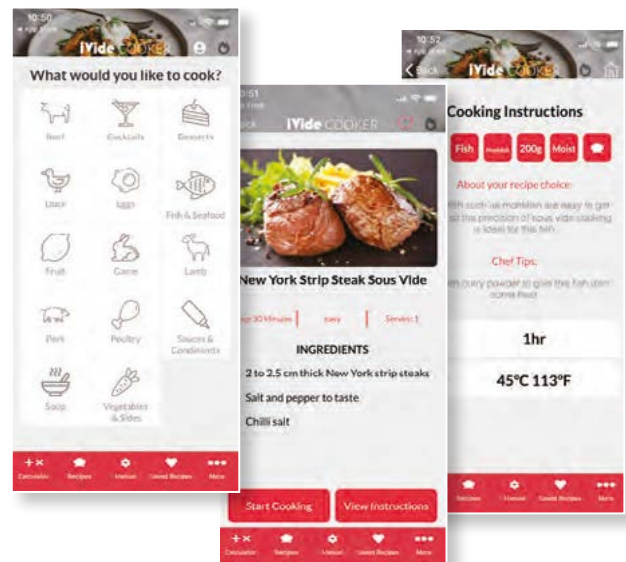



SMOKING GUN RECHARGEABLE – 3 SPEEDS OF SMOKE INFUSION

- Smoking is a very flavourful addition to your meat, fish and vegetable dishes, but can also create a wow-factor when serving.
- The cold smoke is gentle for delicate fruits and vegetables, smoke without changing the texture or temperature.
- One button operation, the smoking gun has 3 speeds
- The aluminium fan chamber functions as a heat sink, cooling the smoke before expelling it.
- Wood requires no pre-soaking prior to smoking.
- Can also be used with tea or spices.
- Removable smoking chamber with integrated mesh filter.
- Flexible silicone hose (50 cm long) for easy injection of smoke into resealable bags and containers.
- Lightweight with a comfortable handle making it easy to use with one hand.
- Powered by a rechargeable Lithium battery of 1000mAh.
- Very complete, comes with 3 spare filter meshes, a tweezer and USB charging cable.
- Wood or herbs for smoking not included.

code	mm
199640	215x70x(H)160



RECHARGEABLE
BATTERY



199640

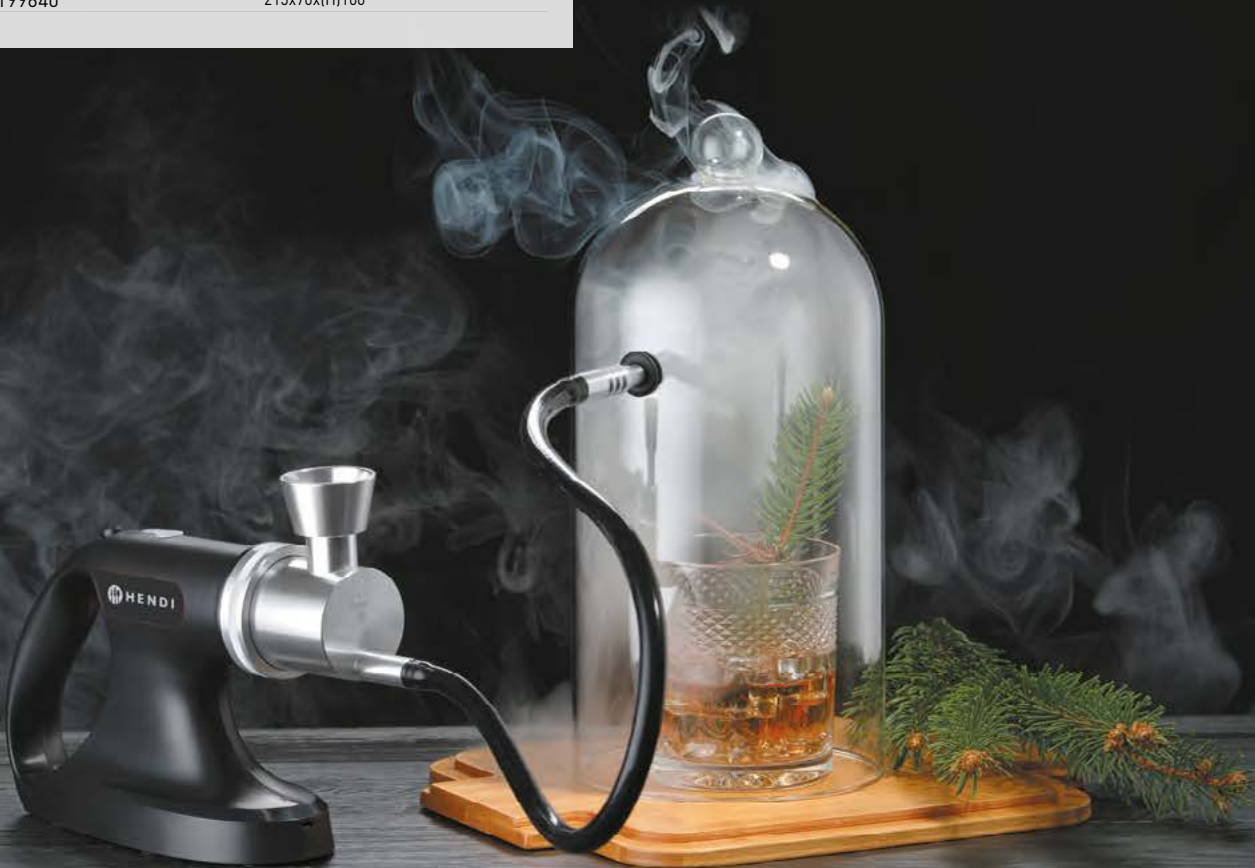



SMOKE INFUSER

- The aluminium body functions as a heat sink, cooling the smoke before expelling it.
- Wood requires no pre-soaking prior to smoking.
- Can also be used with tea or spices.
- Removable smoking chamber with removable filter.
- Large woodchip holder.
- Flexible rubber hose (30 cm long) for easy injection of smoke into resealable bags and containers.

- Compact and lightweight enough to use with one hand.
- Gentle enough for use on delicate fruits and vegetables without changing their texture of temperature.
- Powered by 2 AA batteries, not included.
- Wood or herbs for smoking not included.

code	mm
199992	90x54x(H)122



GLASS DOME WITH VENT

- Made from borosilicate glass, fitted with silicone vent to hold the tube of a smoking gun.
- Ideal to use in combination with a smoking gun.

code	-	mm
199664	Plate dome	ø260x(H)174
199657	Cocktail dome	ø130x(H)282



GLASS DOME

- Ideal to use in combination with the smoking gun.

code	mm
199978	ø275x(H)140



GAS LIGHTER – SET OF 2 PCS.

- Refillable.
- Supplied empty.

code	packed per	mm
198124	2	(L)230





AROMATIC WOOD CHIPS

- Dust and wood chips were obtained from the wood of noble species of deciduous trees - fruit trees - and the wood of barrels of seasoned alcohols: red wine, whiskey and cognac.
- We recommend the latter to connoisseurs of the above liquors, as they give an extraordinary taste experience. The products come from fragments of old oak barrels in

- which the abovementioned alcohols were aged for years!
- In our offer, you will find delicate smoking dust and two types of wood chips - fine and slightly larger. Use them in the smoking process, and you will not only gain an excellent taste and smell of any dish, but you can also present it exceptionally attractive, causing the WOW effect!



Smoking dust

for use with smoking gun and smoke infusers



Smoking chips small

for use directly on the charcoal or in combination with a smoking tray or box



Smoking chips



OAK



BEECH



CITRUS



PEACH



ALMOND



OLIVE

Smoking dust



	OAK	BEECH	CITRUS	PEACH	ALMOND	OLIVE
code	199787	199183	199213	199237	199220	199190
weight	700 g	700 g	700 g	700 g	700 g	700 g

Smoking chips small



	OAK	BEECH	CITRUS	PEACH	ALMOND	OLIVE
code	199282	199275	199305	199329	199312	199299
weight	700 g	700 g	700 g	700 g	700 g	700 g

Smoking chips



	OAK	BEECH	CITRUS	PEACH	ALMOND	OLIVE
code	199374	199367	199398	199411	199404	199381
weight	3 kg	3 kg	3 kg	3 kg	3 kg	3 kg



		RED WINE	WHISKY	COGNAC
Smoking dust				
	code	199244	199251	199268
	weight	700 g	700 g	700 g
Smoking chips small				
	code	199336	199343	199350
	weight	700 g	700 g	700 g
Smoking chips				
	code	199428	199435	199442
	weight	3 kg	3 kg	3 kg



199794

SMOKING DUST ASSORTMENT - SET OF 9 FLAVORS

- For use with cold smoke infusers/smoking guns.
- Assortment of 9 different kinds of very fine aromatic chips.
- Flavours in this set: almond, beech, citrus, cognac, oak, olive, peach, red wine and whisky.

code	weight (kg)
199794	1.35

BIG CHUNKS

- Intended for medium to high temperatures
- Ideal for pizza ovens, outdoor ovens and barbecues - direct to charcoal
- Unique aroma
- Strengthen the taste of your favourite dishes
- Made from the best wood or from the best aging barrels.
- Our offer includes wood chunks made from:
 - wine, whisky, or cognac barrels.
 - beech, olive, citrus, almond, or peach wood.



PEACH

code 199503

weight 3 kg



BEECH

code 199459

weight 3 kg



CITRUS

code 199480

weight 3 kg



OAK

code 199466

weight 3 kg



CHARCOAL MARABU

code 199541

weight 10 kg



ALMOND

code 199497

weight 3 kg



OLIVE

code 199473

weight 3 kg

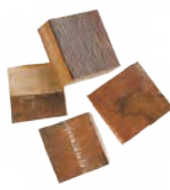

RED WINE

code 199510

weight 3 kg



COGNAC

code 199534

weight 3 kg



WHISKY

code 199527

weight 3 kg



TEPAN-YAKI GRIDDLE

- Non-stick coated surface, easy to clean.
- Robust cool-touch handles for safe transport.
- Maximum temperature: 220-250 °C.
- Detachable power cord with thermostat.



TEPPANYAKI GRIDDLE

- Griddle surface dimensions: 440x230 mm.

code	V	W	mm
238608	230	1800	526x230x(H)120

TEPPANYAKI GRIDDLE

- Griddle surface dimensions: 892x220 mm.

code	V	W	mm
238301	230	1800	1023x220x(H)112

PARTY PAN

- Aluminium with non-stick coating.
- Removable thermostat.
- Suitable for frying, roasting and keeping hot.
- Including lid with clear glass and two insulated handles.



code	V	W	mm
239605	230	1600	ø620x(H)190
239506	230	1400	ø500x(H)190



239605

THERMOSTAT CABLE FOR PARTY PAN

- Replace your broken or lost thermostat cable to extend the service life of your part pans.
- For use with HENDI Party pan 239506 & 239605.

code
239599



239506





External water level indicator



Watch the video



209981

ELECTRIC KETTLE - 1,8 L

- Housing and heating element made of 304 stainless steel.
- Handle, lid and base made of polypropylene.
- 360-degree swivel base.
- Concealed heating element protected against scale which extends the lifetime of the heater and the entire kettle.
- Indicator light informs that the heater is on.
- External water level indicator.
- Internal maximum water level indicator.
- Automatic switch-off after boiling.
- Double dry-boil protection.
- Only suitable for boiling water, boiling other liquids will damage the appliance.

code	liters	V	W	mm
209981	1.8	230	2150	221x163x(H)249



Control panel with digital display



209943

CORDLESS ELECTRIC KETTLE WITH TEMPERATURE CONTROL

- For preparing beverages with indicated brewing conditions, such as green tea, white tea, or yerba mate.
- AISI304 stainless steel housing and heater.
- Polypropylene handle, lid, and base.
- Temperature regulation and maintenance – water can be heated to one of these temperatures: 40°C, 60°C, 80°C, 100°C.
- Heater placed under the bottom, protected against scale.
- Control panel with digital display.
- Thermostat indicator light.
- Internal maximum water level indicator.
- Automatic shut-off function after the water boiled.
- Double protection against switching on an empty kettle.
- Kettle can be rotated – 360° base.
- CAUTION: intended for boiling water only, boiling other liquids may damage the kettle.

code	liters	V	W	mm
209943	1.8	230	1800	225x168x(H)288



Internal maximum water level indicator



209998

ELECTRIC KETTLE - 4,2 L

- Housing and heating element made of stainless steel.
- Handle, lid and base made of polypropylene.
- Concealed heating element protected against scale which extends the lifetime of the heater and the entire kettle.
- Indicator light informs that the heater is on.
- Internal maximum water level indicator.
- Automatic switch-off after boiling.
- Double dry-boil protection.

code	liters	V	W	mm
209998	4.2	230	2000	340x234x(H)290



Watch the video

BAIN-MARIE GASTRONORM



238905



238912

KITCHEN LINE BAIN-MARIE

- GN 1/1 container.
- Temperature control up to 85 °C.
- Stainless steel water tank with appropriately contoured inner corners for easy cleaning.
- Equipped with an on/off switch, a thermostat and an indicator light.
- Suitable for GN pans up to 150 mm deep.
- Supplied without GN pans.



code	V	W	mm
238905	230	1200	340x540x(H)250

KITCHEN LINE BAIN-MARIE WITH DRAIN TAP

- GN 1/1 container.
- Temperature control up to 85 °C.
- Stainless steel water tank with appropriately contoured inner corners for easy cleaning.
- Equipped with an on/off switch, a thermostat and an indicator light.
- Suitable for GN pans up to 150 mm deep.
- Supplied without GN pans.



code	V	W	mm
238912	230	1200	340x540x(H)250

THERMO SYSTEM



201107



201206

THERMOSYSTEM 1

- Enamelled pan Ø 185 mm.
- Stainless steel bain-marie pan with lid.
- Fitted with power regulator and indicator light.



code	liters	V	W	mm
201107	4.2	230	200	265x265x(H)245

THERMOSYSTEM 2

- 2 enamelled pans Ø 185 mm.
- 2 stainless steel bain-marie pans with lids.
- Fitted with two power regulators and indicator lights.



code	liters	V	W	mm
201206	8.4	230	400	505x265x(H)245



S.S. PP
stainless steel polypropylene



Watch the video

THERMAL PROCESSING



240410



240403

RICE COOKER WITH STEAMER FUNCTION

- The housing is made of stainless steel.
- Removable inner pot made from aluminium with a non-stick coating, easy to clean.
- The hinged polypropylene lid is fitted with a convenient handle, airtight gasket, and vent valve.
- The lid is closed tightly thanks to the integrated latch.
- With integrated condensation collector prevents the workplace from getting wet.
- 2 operating modes - cooking and keeping warm; after cooking, the appliance goes into keep warm mode.
- Can also be used to steam vegetables with the included steam basket.
- Capacity: 10 scoops of dry rice (15-20 servings of cooked rice).
- Included: steamer basket, rice measuring cup and spoon.

code	liters	V	W	mm
240410	1.8	230	700	ø280x(H)285

PROFI LINE RICE COOKER & WARMER 5.4 L

- Housing made of stainless steel.
- Internal aluminum container with non-stick coating, removable, easy to clean.
- Stainless steel hinged lid with a seal and vent valve.
- Snap fastener for an easy and tight closing of the cooker.
- A special container for collecting condensation that is dripping from the lid protects the work area from getting wet.
- 2 operating modes - cooking and temperature maintenance mode; when the cooking is finished, the device switches to temperature maintenance mode.
- Capacity: Suitable for 30 cups of dry rice (45-60 servings of cooked rice).
- Measuring cup, rice spoon and silicone non-stick pad included.

code	liters	V	W	mm
240403	5.4	230	1950	455x455x(H)380

NEW

NON-STICK MAT FOR RICE COOKERS

- For HENDI rice cooker 240403.

code
930830



930830



Inner pot is removable



240441

RICE COOKER 4.2 L

- Housing is made of rolled steel painted white, easy to clean.
- Inner pot made from aluminium with a non-stick coating, easy to clean.
- The twist lock, stainless steel lid is fitted with a stay cool handle.
- The handles have a special design allowing them to act as a lid holder, store a hot lid safely and always keep the lid at hand.
- Handles and legs are made of non-heating, durable polypropylene.
- Two operating modes - cooking and keeping warm; after cooking, the appliance goes into keep warm mode.
- Capacity: 23 scoops of dry rice (±46 servings of cooked rice).
- Included: rice measuring cup and spoon.
- Net weight: 4.8 kg.

code	liters	V	W	mm
240441	4.2	230	1550	420x380x(H)240



240458

RICE COOKER 10 L

- Housing is made of rolled steel painted white, easy to clean.
- Inner pot made from aluminium with a non-stick coating, easy to clean.
- The twist lock, stainless steel lid is fitted with a stay cool handle.
- The handles have a special design allowing them to act as a lid holder, store a hot lid safely and always keep the lid at hand.
- Handles and legs are made of non-heating, durable polypropylene.
- Two operating modes - cooking and keeping warm; after cooking, the appliance goes into keep warm mode.
- Capacity: 50 scoops of dry rice (±100 servings of cooked rice).
- Included: rice measuring cup and spoon.
- Net weight: 10.35 kg.

code	liters	V	W	mm
240458	10	230	2900	555x495x(H)365



S.S.
stainless steel2000 W
230 V

264119

SALAMANDER WALL MOUNTABLE

- Conforms to the IPX4 norm - full protection against dampness.
- Can be installed against the wall without requiring additional brackets, saves space in the kitchen.
- Perfect for grilling or heating up dishes or casseroles.
- Continuous temperature regulation: 50°-300°C.
- With top heating element.
- Fitted with thermostat, 30 min. timer and an indicator lamp.
- 4 possible grid heights.
- Supplied with: grid handles fitted with heat shield, crumb tray.
- Internal dimensions: 460x265x(H)165 mm.
- Cable length: 1.3 m.
- Made of stainless steel.

code	V	W	mm
264119	230	2000	610x310x(H)280

NEW2850 W
230 V

264126

S.S.
stainless steel**SALAMANDER GN 1/1 WALL MOUNTABLE**

- Conforms to the IPX4 norm - full protection against dampness.
- Can be installed against the wall without requiring additional brackets, saves space in the kitchen.
- Continuous temperature regulation: 50°-300°C.
- With top heating element.
- Fitted with thermostat, 30 min. timer and an indicator lamp.
- 4 possible grid heights.
- Supplied with: grid handles fitted with heat shield, crumb tray.
- Internal dimensions: 460x265x(H)165 mm.
- Cable length: 1.3 m.
- Made of stainless steel.

code	V	W	mm
264126	230	2850	780x490x(H)310

S.S.
stainless steel3600 W
230 V

264300

SALAMANDER

- Ideal for casseroles, grilling and heating up dishes.
- Temperature control: 50°-300°C.
- With top heating element.
- Fitted with thermostat, 30 min. timer and indicator lamp.
- 4 possible grid heights.
- Supplied with: grid with handles and crumb tray.
- Internal dimensions: 646x408x(H)337 mm.
- Made of stainless steel.

code	V	W	mm
264300	230	3600	800x472x(H)456

**HEATS UP
IN 10s**S.S.
stainless steel4500 W
400 V

264331

With 9 quartz heaters
for faster heating**QUARTZ SALAMANDER MAXI GN 1/1**

- Salamander grill with 9 quartz heaters for faster heating, grilling and grating food.
- Steel guard of heaters protecting against damage.
- Stainless steel housing.
- Two chrome-plated grates with dimensions of 530x340 mm and two removable handles.
- Two levels for vertical position of each grate with distance of 70 and 45 mm.
- Stainless steel crumb tray Quartz heaters - 3 heaters on three independent levels.
- Heater timer - turns on for up to 15 min or continuous operation 1.3 m power cable without plug.

code	V	W	mm
264331	400	4500	685x396x(H)452



SALAMANDER WITH QUARTZ INFRARED HEATING ELEMENTS GN 1/1

- It is possible to place GN1/1 trays in the chamber.
- Ideal for grilling or heating up dishes or sandwiches.
- With top & bottom Quartz infrared heating element.
- Fitted with thermostat, 15 min. timer and indicator lamp.
- 3 possible grid heights, grid handles fitted with heat shield.
- With crumb tray.
- Conforms to the IPX3 norm.



code	V	W	mm
264409	230	3645	689x397x(H)318



264607

LIFT SALAMANDER 450

- Type 450 - stainless steel frame.
- Ideal for grilling or keeping dishes/sandwiches warm and crisp.
- Thermostat continuously adjustable up to a maximum of 300°C, with indicator lights.
- Adjustable height by means of smoothly running lifting system.
- Removable dripping/crumb tray with 440x320 mm grid.

code	V	W	mm
264607	230	2800	480x520x(H)530



264706

LIFT SALAMANDER 600

- Type 600 - stainless steel frame.
- Ideal for grilling or keeping dishes/sandwiches warm and crisp.
- Thermostat continuously adjustable up to a maximum of 300°C, with indicator lights.
- 2 independent heating areas.
- Adjustable height by means of smoothly running lifting system.
- Removable dripping/crumb tray with 590x350 mm grid.

code	V	W	mm
264706	230	3600	600x520x(H)530





WAFFLE MAKER ROUND

- Make delicious Belgian style waffles without a hassle, ideal for a self-serve waffle station.
- You can make up to 20 waffles per hour.
- Waffle irons made of enameled cast aluminum, can be cleaned with a brush.
- The waffles measure \varnothing 190 mm and up to 23 mm thick.
- The temperature can be set steplessly between 50°C and 220°C.
- The timer can be set up to 15 minutes.

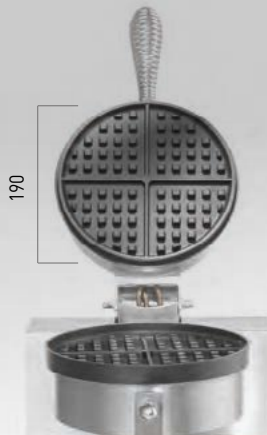

code	V	W	mm
212172	230	1000	250x380x(H)590



212172

- Perfect for all types of catering establishments who wants to add these fun waffles on a stick or corn dogs to their offer.
- Grooves are cut out of the waffle iron so you can insert the stick and still close the waffle iron.
- Waffle irons made of enameled cast aluminum, can be cleaned with a brush.
- Open the waffle iron easily with the large, stay-cool, handle.
- The housing is made of 18/0 stainless steel, guaranteeing a long service life and easy cleaning.

- Fitted with a drip tray for dough and fat, helps you keep your work space clean.
- Ventilation slots in the housing protect the controls against overheating.
- The temperature is continuously adjustable from 50°C to 220°C.
- Timer can be set up to 15 minutes.



212189

WAFFLE MAKER CORN DOG

- It's possible to bake 6 lollypop waffles or corn dogs at the same time.
- Net weight: 10 kg.

code	V	W	mm
212189	230	1550	390x335x(H)230



212165

WAFFLE MAKER LOLLYPOP

- It's possible to bake 4 lollypop waffles at the same time, each 255 mm long (without the stick) and shaped like an elongated cone.
- Net weight: 10.5 kg.

code	V	W	mm
212165	230	1750	310x395x(H)230

WAFFLE MAKERS

- Waffle irons made of enameled cast iron, can be cleaned with a brush.
- Thermostatic temperature control.
- Including waffle fork.
- Insulated handle.



212103

212127

212134

WAFFLE MAKER ,LIÈGE'

- Liège waffles, two 4x6 rectangular patterns.

code	V	W	mm
212103	230	1500	320x437x(H)251

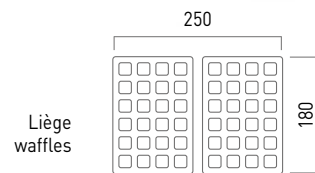

WAFFLE MAKER ,BRUSSELS'

- Brussels waffles, two 3x5 rectangular patterns.

code	V	W	mm
212127	230	2200	320x437x(H)277

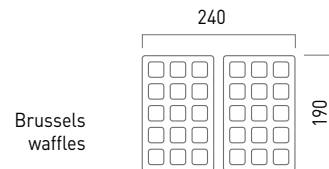

WAFFLE MAKER ,HEART'

- Flower waffles, five conjoined heart-shaped patterns.

code	V	W	mm
212134	230	2200	320x437x(H)251

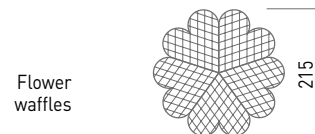

282755



282731

**COTTON CANDY MACHINE**

- Stainless steel removable bowl, suitable for dishwashers.
- The bowl is fastened by 4 secure clamps.
- Motor housing finished with a pink coating.
- Fitted with a drawer for sticks, sugar, dyes, etc.
- Separate switches for power on and the heating elements, with integrated lamps.
- Voltmeter showing actual voltage.
- Sugar dispenser included.
- Overload fuse protects the motor against burning in the event of a blockage.
- Weight: 11 kg.

code	V	W	mm
282731	230	1200	520x520x(H)480

COVER FOR COTTON CANDY MACHINE

- Protect the cotton candy machine from dust and dirt.
- Made of plexiglass.
- Suitable for HENDI cotton candy machine 282731.



code	mm
282755	ø520x(H)350



212028

525197

CRÊPE MAKER

- Designed for making crêpes.
- Baking plate Ø 400 mm made of cast iron with a ceramic coating.
- Very even heat distribution across the surface.
- Including wooden spreader.
- Stainless steel housing.
- Thermostat continuously adjustable from 50 to 300°C.
- With protection from overheating and EGO thermostat.

code	V	W	mm
212028	230	3000	470x520x(H)160

WOODEN SPREADER FOR CRÊPE MAKERS

- Characteristic shape - perfect for spreading the dough on the cooking surface.
- Recommended for use with the pancake maker with the code: 212028

code
525197

NEW



NACHO WARMER

- Housing made of aluminium and tempered glass.
- Internal compartment made of AISI 403 stainless steel.
- Fitted with a removable crumb collecting tray.
- Max. heating temperature: 55°C
- Max. load: 30 L

code	V	W	mm
282779	230	300	320x390x(H)510



282779

NEW

SAUCE BAIN-MARIE WITH DISPENSER

- Housing, spring in the dispenser and mechanical system made of AISI 304 stainless steel.
- The lower element of the dispenser made of polypropylene.
- Removable: lid, dispenser pump.
- Lid fitted with 2 snap latch locks.
- With overheating protection sensor - it turns on the sound alarm and automatically cuts the heating off.
- Adjustable heating temperature: up to 90°C.
- Dispensed sauce portion: 35 ml.
- Not dishwasher safe.

code	V	W	mm
558126	230	900	ø180x(H)500

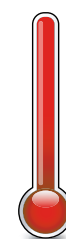

<90 °C

558126



FRENCH FRIES AND NACHOS FUNNEL SCOOP

- Fill opening 70 mm.
- Left and right handed.

code	mm
642566	233x205



642566



Always up-to-date!

Our catalogue is also available online with nice features like:

- + powerful search tool
- + easy navigation
- + fast sharing.

But most important of all, **up-to-date prices.**

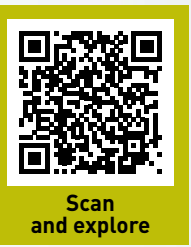

THERMAL PROCESSING



WELCOME TO HENDI'S DIGITAL CATALOGUE

FRIENDLY/ FUNCTIONAL/ ECOLOGICAL

- + EASY TO NAVIGATE
- + CLICK THE REGISTER TO GO TO THE CHAPTER
- + EASY AND POWERFULL SEARCH FUNCTION
- + MORE INFO ABOUT THE PRODUCT / PICTURES / VIDEOS
- + CREATE YOUR OWN CATALOGUE
- + SHARE WITH A CLICK



282748



282762



NEW



With convenient collection drawer for crumbs and unpopped popcorn kernels.

POPCORN MACHINE

- Frame made of aluminium alloy.
- Robust housing made of tempered glass and powder coated steel in two colours available: red or black.
- With a hinged service door made of tempered glass.
- Popcorn heating pan with stirring unit. Lid with handles made of non-heating material.
- Popcorn scooping flap.
- Crumb drawer under the chamber for easy disposal of un-popped kernels and crumbs.

- Un-popped kernels and crumbs are collected underneath the crumb drawer.
- Illuminated interior. Heated bottom of the popcorn chamber.
- Cycle duration: ±2 min. - 150g of corn kernels per cycle.
- Net weight: ±25 kg.

code	colour	V	W	mm
282762	Black	230	1500	560x420x(H)770
282748		230	1500	560x420x(H)770

CHOCOLATE FOUNTAIN

- Made of stainless steel.
- With warming function, temperature can be set up to 150 °C.
- Minimal chocolate capacity: 1 kg.
- Maximal chocolate capacity: 8 kg.
- With separate switch for motor and heating element.



Chocolate fountain 3 tiers



Chocolate fountain 5 tiers



Chocolate fountain 6 tiers



code	274101	274156	274163
temperature control	45°C	110°C	150°C
min. capacity chocolate	1 kg	2,5 kg	2,5 kg
max capacity chocolate	1,5 kg	6 kg	8 kg
dimensions	ø210x(H)390 mm	ø330x(H)700 mm	ø370x(H)840 mm
power/voltage	170 W/230 V	265 W/230 V	300 W/230 V



SAUSAGE ROLLING GRILLS

- Stainless steel housing.
- Quick heating and heat recovery.
- Non-stick coated rollers.
- Removable, easy-to-clean drip tray.
- Roller width: 42 cm.
- Temperature control up to 150 °C.



11 rollers
1180 W
230 V



7 rollers
740 W
230 V

268506



268704



9 rollers
940 W
230 V

268605



14 rollers
1480 W
230 V

268735

SAUSAGE ROLLING GRILL - ONE ZONE

code	-	V	W	mm
268506	7 rollers	230	740	520x325x(H)175
268605	9 rollers	230	940	520x400x(H)175

SAUSAGE ROLLING GRILL - TWO ZONES

code	-	V	W	mm
268704	11 rollers	230	1180	520x477x(H)175
268735	14 rollers	230	1480	520x591x(H)175



268551

GLASS COVER FOR SAUSAGE ROLLER GRILLS

- Allows up to 20% reduction in consumed electricity.
- Reduces the time to grill sausages up to 15% thanks to heat accumulation under the glass cover.
- Maximum entry height 250 mm.
- Constructed from three glass elements, each 4 mm thick.
- Stainless steel structure supports the glass elements.
- 4 elements made of high temperature resistant plastic for mounting the cover to the grill.
- Warning: Glass cover fits only the new sausage roller grills with holes in frames.

code	for sausage rolling grill	mm
268551	7 [268506]	470x325x(H)240
268612	9 [268605]	470x401x(H)250
268711	11 [268704]	470x477x(H)250
268742	14 [268735]	470x591x(H)250

18/0
stainless steel



265000

SAUSAGE WARMER

- Heats hotdog sausages and keeps them warm.
- Stainless steel housing, sausage container made of anodized aluminum and glass.
- With adjustable power.

code	V	W	mm
265000	220-240	450	240x322x(H)466

S.S.
stainless steel



240502

SAUSAGE WARMER

- Stepless thermostat temperature control up to 85°C.
- With handles for easy transport.
- Sausage container capacity: 10 L.
- Lid with insulated, cool-touch handle.

code	V	W	mm
240502	230	1000	330x280x(H)250

S.S.
stainless steel



265109

SAUSAGE CUTTER - ELECTRIC

- Electric sausage cutter with double blade knife and adjustable thickness.
- Extra long insertion tunnel for many types of sausages.
- Maximum diameter of 48 mm.

code	V	W	mm
265109	230	135	230x185x(H)325



222805

S.S.
stainless steel

 wash

SAUSAGE CUTTER - MANUAL

- Stable footing by suction cups.
- High-quality serrated blades.
- Easy to clean.
- Cuts 11 slices.

code	mm
222805	275x170x(H)235



630716

18/8
stainless steel

SAUSAGE CUTTER

code	mm
630716	(L)200

3000 W
230 V



S.S.
stainless steel

262214

MULTI TOASTER 6 TONGS

- 2 Layers with 6 toaster tongs - stainless steel.
- Infrared quartz tubes for prompt heating, temperature can reach maximum within 30 seconds.
- Tubes cool down in seconds.
- Switch for selecting different heating groups.
- 15 Minutes mechanical timer with bell.
- 6 Toaster tongs included.

code	V	W	mm
262214	230	3000	438x290x(H)402



S.S.
stainless steel

262801

TOASTER TONG

code	mm
262801	100x340x(H)64



1200 W
230 V

261163

S.S.
stainless steel

SANDWICH TOASTER

- Stainless steel housing.
- Tongs fitted with insulated handles made of PF resin.
- Left and right slot separately operable.
- Timer with alarm adjustable to a maximum of 8 minutes.
- Removable crumb tray.

code	V	W	mm
261163	230	1200	200x300x(H)223



921500

S.S.
stainless steel

TONG FOR SANDWICH TOASTER

- For use with HENDI sandwich toaster 261163.
- Fitted with insulated handles made of PF resin.

code	mm
921500	180x60x(H)180



CONVEYOR TOASTER SINGLE

- One row of bread slices fit on the conveyor.
- Two separate heating elements, one below and one above the conveyor.
- Suitable for continuous toasting of sliced bread.
- Supplied with front and back trays.
- Conveyor speed is adjustable, toasting time between 0:45 and 3:15 minutes.

code	V	W	mm
261200	220-240	1340	288x418x(H)387



CONVEYOR TOASTER DOUBLE

- Two rows of bread slices fit next to each other on the conveyor.
- Two separate heating elements.
- Suitable for continuous toasting of sliced bread.
- Supplied with front and back trays.
- Adjustable toasting time up to 3 minutes.

code	colour	V	W	mm
261309	Steel	230	2240	418x368x(H)387
261347	Red	230	2240	418x368x(H)387
261354	Black	230	2240	418x368x(H)387



20 L
1050 W
230 V

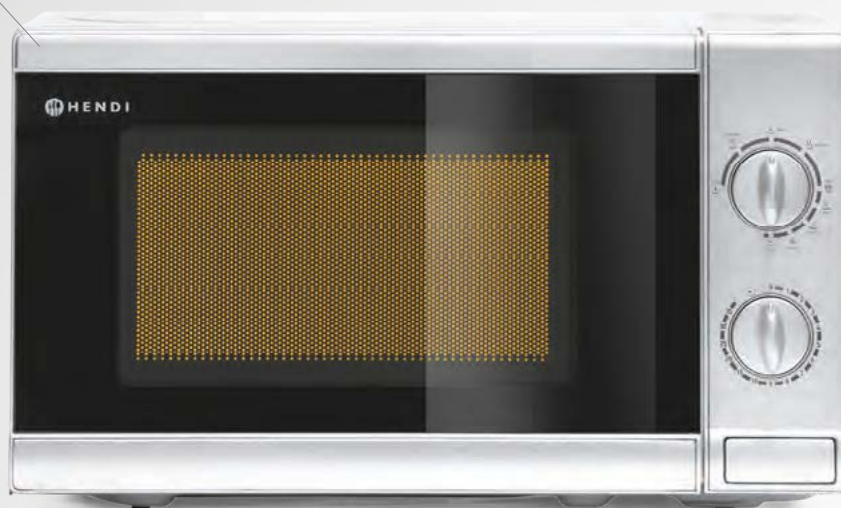

281710

MICROWAVE WITH GRILL HENDI 1050 W, 20 L

281710

- Stainless steel housing and front panel.
- Easy to read control panel.
- Electromechanical control with two knobs adjusting time and power – 9 levels.
- Top magnetron antenna with rotating shaft ensures uniform distribution of energy.
- Built-in air filter to protect against external factors and dust.
- Airtight door with a glass pane for observing processes in the illuminated microwave interior.
- Push-button opening for easy operation.
- Chamber interior:
 - dimensions 304x306x(H)206, capacity 20 L.
 - painted white.
 - easy to clean.
 - no breaking of plates thanks to appropriately rounded edges.
- Multifunctional use:
 - defrosting.
 - 4 levels of microwave power: Low, Medium, Medium High, High.
 - function of combining standard and grill mode: Combi (3 levels).
 - grill (power 1000 W).
 - the end of the cooking cycle is signalled by an acoustic alarm.
 - 4 power levels.
- Microwave power: 700 W.
- Includes 255 mm glass turntable plate and grill stand.
- Suitable for round (up to ø280 mm) plates.
- Maximum single operating time: 35 minutes.
- Equipped with a cable with a grounding plug.
- Weight: 11.1 kg.



code	liters	V	W	mm
281710	20	230	1050	440x330x(H)259



25 l
1550 W
230 V



281352

MICROWAVE 1000W HENDI 1550 W, 25 L

281352

- Housing and interior of the chamber with ceramic bottom made of stainless steel.
- Easy to read control panel.
- Electromechanical control with one knob adjusting time from 15 s to 6 min.
- Lower rotating magnetron antenna for uniform energy distribution, no rotating disk.
- Built-in air filter to protect against external factors and dust.
- Door with large glass pane for observing processes in the illuminated microwave interior.
- Tight latch closure; easy opening – no locking mechanism.
- Chamber interior:
 - dimensions 327x346x(H)200, capacity 25 L.
 - easy to clean.
 - no breaking of plates thanks to appropriately rounded edges.
 - ceramic bottom.
- Multifunctional use:
 - defrosting.
 - 6 suggested time programs for preparation of selected dishes/ beverages.
 - the end of the cooking cycle is signalled by an acoustic alarm.
 - 4 power levels.
- Microwave power: 1000 W.
- Suitable for round (up to $\varnothing 320$ mm) and rectangular plates.
- Maximum single operating time: 6 minutes.
- Equipped with a cable with a grounding plug.
- Weight: 15.1 kg.

code	liters	V	W	mm
281352	25	230	1550	511x432x(H)311



23 l
1550 W
230 V



281444

MICROWAVE PROGRAMMABLE 1000W HENDI 1550 W, 23 L

281444

- Housing and interior of the chamber with ceramic bottom made of stainless steel.
- Easy to read control panel.
- Electronic control.
- Lower rotating magnetron antenna for uniform energy distribution, no rotating disk.
- Built-in air filter to protect against external factors and dust.
- You can select the desired program on the touch panel.
- Door with large glass pane for observing processes in the illuminated microwave interior.
- Tight latch closure; easy opening – no locking mechanism.
- Chamber interior:
 - dimensions 327x346x(H)200, capacity 23 l.
 - easy to clean.
 - no breaking of plates thanks to appropriately rounded edges.
 - ceramic bottom.
- Multifunctional use:
 - defrosting.
 - 10 default programs.
 - possibility to save up to 100 programs (up to 3 stages in one program).
 - automatic time conversion for double portions.
 - the end of the cooking cycle is signalled by an acoustic alarm.
 - 4 power levels.
- Microwave power: 1000 W.
- Suitable for round (up to ø320 mm) and rectangular plates.
- Maximum single operating time: 60 minutes.
- Equipped with a cable with a grounding plug.
- Weight: 15.5 kg.

code	liters	V	W	mm
281444	23	230	1550	511x432x(H)311



34 l
 3000 W
 230 V



281369

MICROWAVE PROGRAMMABLE 1800W HENDI 3000 W, 34 L

281369

- Housing and interior of the chamber made of stainless steel.
- Chamber fitted with a ceramic floor.
- Lower and upper rotating microwave antennas for uniform energy distribution, no rotating parts in the chamber.
- Built-in air filter protects against dust and dirt.
- Easy to read control panel, select the desired program on the touch panel.
- Door with large window for observing processes in the illuminated microwave chamber.
- Tight latch closure; easy opening – no locking mechanism.
- Chamber interior:
 - dimensions 360x409x(H)225 mm, capacity 34 l.
 - easy to clean.
 - no breaking of plates thanks to appropriately rounded edges.
 - ceramic bottom.
- Multifunctional use:
 - defrosting.
 - 10 default programs.
 - possibility to save up to 100 programs (up to 3 stages per program).
 - automatic time conversion for double portions.
 - the end of the cooking cycle is signalled by an acoustic alarm.
- Microwave power: 1800 W.
- Suitable for round (up to ø355 mm) and rectangular plates.
- Maximum single operating time: 60 minutes.
- Fitted with a grounded plug.
- Weight: 32.3 kg.



code	V	W	mm
281369	230	3000	574x528x(H)368



18 L
 3000 W
 230 V

281376

MICROWAVE PROGRAMMABLE, WITH USB PORT 1800W HENDI 3000 W, 18 L

281376

- Housing and interior of the chamber made of stainless steel.
- Chamber fitted with a ceramic floor.
- Easy to read touch control panel with push buttons and digital display that shows time and power.
- Lower and upper rotating microwave antennas for uniform energy distribution, no rotating parts in the chamber.
- Built-in air and grease filter to protect against external factors.
- A special system that reminds you to clean the filter.
- Door with large window for observing processes in the illuminated microwave chamber.
- Tight latch closure; easy opening – no locking mechanism.
- Chamber interior:
 - dimensions 330x310x(H)175, capacity 18 L.
 - easy to clean.
 - no breaking of plates thanks to appropriately rounded edges.
 - ceramic floor.
- Multifunctional use:
 - defrosting.
 - 10 default programs.
 - 10 power levels.
 - upload programs via the USB port,
 - possibility to save up to 100 programs, including up to 20 custom, multistage programs.
 - automatic time conversion for double or triple portions.
 - the end of the program is signalled by an alarm. Possibility to change the sound or turn it off completely.
- Microwave power: 1800 W.
- Suitable for round (up to ø300 mm) and rectangular plates.
- Maximum single operating time: 60 minutes.
- Fitted with a grounded plug.
- Comes with a USB card, software included.
- Weight: 31.8 kg.



code	V	W	mm
281376	230	3000	563x420x(H)340





code	281710	281352	281444	281369	281376
COOKING AND PROGRAMMING					
Control	electromechanical	electromechanical	electronic	electronic	electronic
Number of programs / stages	9/1	1/1	100/3	100/3	100/3
Number of power levels	9	1	4	4	10
Maximum time	35 min	6 min	60 min	60 min	60 min
STANDARD EQUIPMENT					
Microwave source	top magnetron antenna	lower rotating magnetron antenna	lower rotating magnetron antenna	lower and upper rotating magnetron antenna	lower and upper rotating magnetron antenna
Number of magnetrons	1	1	1	2	2
Air filter	YES	YES	YES	YES	YES
USB port	-	-	-	YES	YES
Additional accessories	YES - grid	-	-	-	-
DIMENSIONS					
External dimensions	440x330x(H)259 mm	511x432x(H)311 mm	511x432x(H)311 mm	574x528x(H)368 mm	563x420x(H)340 mm
Chamber dimensions	304x306x(H)206 mm	327x346x(H)200 mm	327x346x(H)200 mm	360x409x(H)225 mm	330x310x(H)175 mm
Chamber capacity	20 l	25 l	23 l	34 l	18 l
Maximum plates diameter	280 mm	320 mm	320 mm	355 mm	300 mm
TECHNICAL PARAMETERS					
Power	1050 W	1550 W	1550 W	3000 W	3000 W
Voltage	230 V	230 V	230 V	230 V	230 V
Weight	11,1 kg	15,1 kg	15,5 kg	32,3 kg	31,8 kg

COOKING TIMES vs APPLIANCE POWER

Power	700	1000	1100	1400	1800
 Cooking time	0:35	0:25	0:22	0:18	0:12
	1:05	0:52	0:48	0:37	0:27
	1:35	1:14	1:06	0:57	0:39
	2:05	1:39	1:29	1:10	0:52
	5:00	4:03	3:34	2:50	2:10
	10:00	8:15	7:23	5:40	4:00





225479

LOW TEMPERATURE OVEN

- Designed for slowly preparing or regenerating food, by means of a very accurately set and controlled process.
- With core temperature probe, separately adjustable.
- Recessed handles in the sides.
- Easy to clean door seal.
- Oven chamber is heated on 4 sides, uniformly distributing the heat throughout the chamber.
- Energy efficient due to extra insulation.
- Seamless oven chamber with rounded corners, easy to clean.

- Temperature adjustable by 1 degree increments - oven chamber up to 120°C, core temperature and keep warm up to 100°C.
- Door hinges left or right, easy to convert.
- Digital setting and readout of time, set temperature, and current core/chamber temperatures.
- Stainless steel pan and tray holder, suitable for GN 1/1 containers, grids and trays as well as 600x400 mm bakery trays, on 3 levels.

code	V	W	mm
225479	230	1200	495x690x(H)415



225929

CONVECTION STEAM OVEN WITH GRILL 4X GN 2/3

- High-quality stainless-steel body and chamber.
- Manual control panel with knobs for function, temperature, time and amount of steam.
- Has functions for defrost, pre-heat, convection, grill, steam or a combination of those functions.
- Temperature can be set up to 280°C.
- Timer can be set up to 120 minutes.
- Convection by means of two heating elements and one fan.
- With top grill elements.
- Oven fits 4 GN 2/3 trays, distance between the trays is 70 mm.
- Supplied with 1 grid GN 2/3.
- Convection 3 kW, grill: 1.8 kW.
- Chamber heaters: bottom 1.6 kW, top 0.7 kW.
- Adjustable feet from 55 to 75 mm.

code	V	W	mm
225929	230	3000	620x555x(H)585

STAND FOR CONVECTION STEAM OVEN WITH GRILL 4X GN 2/3

- For use in combination with convection steam oven with grill 225929.

code	mm
224823	580x390x(H)750



224823





CONVECTION STEAM OVENS



227060



Two highly efficient fans, distributing hot air evenly



CONVECTION OVEN H90

- Housing Made of stainless steel.
- Cool touch door with double glazing, which can be removed for easy cleaning.
- Partially enamelled chamber with interior lighting.
- Heating by means of 2 heating elements and 2 fans.
- Temperature adjustable from 50°C to 300°C.
- Timer: 0-120 min.
- Fits 4 438x315 mm trays.
- Guides interspaced at: 70 mm.
- Supplied with 4 trays.
- Stand: 223468

code	V	W	mm
227060	230	2670	595x595x(H)570

Fits four aluminium trays



Double, heat resistant glass



Fitted with interior lighting



210





227077

CONVECTION OVEN WITH HUMIDIFICATION H90S

- Housing Made of stainless steel.
- Cool touch door with double glazing, which can be removed for easy cleaning.
- Partially enamelled chamber with interior lighting.
- Heating by means of 2 heating elements and 2 fans.
- Temperature adjustable from 50°C to 300°C.
- Direct humidification, manually operated with a button.
- Water inlet, which can be connected to water supply, at the back
- Timer: 0-120 min.
- Fits 4 436x315 mm trays.
- Guides interspaced at: 70 mm.
- Supplied with 4 trays.
- Stand: 223468

code	V	W	mm
227077	230	2670	595x595x(H)570

Direct humidification



ACCESSORIES



GRID FOR OVENS H90 AND H90S

- Suitable for 227060 and 227077.

code	mm
801970	433x338



TRAY FOR OVENS H90 AND H90S

- Suitable for 227060 and 227077.

code	mm
943380	437x314x(H)8



STAND FOR OVENS H90 & H90S

- Suitable for H90 and H90S ovens 227060, 227077.

code	mm
223468	595x425x(H)700





STEAM CONVECTION OVEN

- Two reversible fans.
- Direct humidification, adjustable in 5 steps.
- Fits up to four 600 x 400 mm trays, not included.
- Chamber made of stainless steel 18/10.
- Double layer glass door, cools front pane by means of natural convection.
- Tray support spacing 73 mm

TRAY

600x400

CONVECTION STEAM OVENS



225523



NEW



224670

4x

600x400x(H)20

4x

600x400x(H)20

code	225523	225516
type	three-phase	convection oven
control	electromechanical	electromechanical
tray support spacing	73 mm	73 mm
external size	790x750x(H)635 mm	790x750x(H)635 mm
number of fans	2 - with reverse	2 - non-reversible
thermostat	50°C up to 300°C electromechanical	50°C up to 300°C electromechanical
humidification	direct, 5-step, manually operated	indirect, manually operated with a button
power/voltage	6,4 kW/400 V	3,2 kW/230 V
weight	58 kg	50,4 kg
	STAND FOR OVENS	STAND FOR OVENS
code	224670	224670
dimensions	540x460x(H)700 mm	540x460x(H)700 mm

CONVECTION OVEN MULTIFUNCTIONAL

- Fits 4 trays 429 x 345 mm, 4 trays included.
- One non-reversible fan.
- Body and chamber made of stainless steel.
- Double layer glass door, cools front pane by means of natural convection.
- Tray support spacing 74 mm.



TRAY
429x345



225165

4x
429x345

code	225165
type	convection oven multifunctional
control	electromechanical
capacity	4 trays 429x345x(H)9 mm
tray support spacing	74 mm
external size	590x695x(H)590 mm
non-reversible fan	1
thermostat	50°C up to 260°C electromechanical
multifunctional	8 baking options
humidification	
power/voltage	2,6 kW/230 V
weight	36,4 kg



NEW

935569

OVEN TRAY FOR CONVECTION OVEN MULTIFUNCTIONAL

- For HENDI Convection oven multifunctional 225165

code	mm
935569	429x345



CONVECTION STEAM OVENS MANUAL NANO GN-SIZE

S.S.
stainless steel

NANO

- A convection steam oven combines the efficiency of a convection oven with the capabilities of a steam oven.
- These modes can be used separately or in conjunction with one another.
- These ovens are the way to go when you want to create scrumptious baked goods, vegetables with a bite, flavourful roasted meat and poultry or perfectly steamed fish.
- Steam is generated by directly spraying water on the heaters.
- The steam levels in the chamber are controllable and the oven has multiple automated features to maintain the set levels.
- A direct water connection is needed: 3/4", max 30°C, 150-200 kPa (2 bar), only treated, softened water.
- Housing and chamber are made of high-quality stainless steel, the chamber is equipped with a drain in the bottom.
- The powerful 6 bladed fan(s) have auto-reverse and can spin at two speeds (1400/2800 rpm), this results in ideal distribution of air in chamber and preventing inner turbulence.
- The fan motor has double bearings and 250W of power.
- The manual control panel has thermostat and steaming indicator lights and three large knobs for setting the time, temperature and amount of steam.
- Timer can be set up to 120 minutes, temperature up to 260°C.
- The door is fitted with two layers of glass with space for gravity ventilation, this keeps the outside glass cool to the touch.
- Outside glass can be removed to ease cleaning.
- Door gasket is fitted in the chamber and removable to ease cleaning and replacement.
- The chamber is fitted removable GN-tray guides and halogen lighting.



5x

GN 2/3



7x

GN 1/1



12x

GN 1/1

code	223307	223116	223093
tray support spacing	67 mm	67 mm	67 mm
external size	700x714x(H)628 mm	920x834x(H)859 mm	920x834x(H)1195 mm
number of fans with reverse	1	2	3
power/voltage	5,4 kW/400 V	10,8 kW/400 V	16,1 kW/400 V
weight	64 kg	117 kg	151 kg
FLOOR STAND			
code	223666	223659	223642
dimensions	700x580x(H)700 mm	940x640x(H)700 mm	940x640x(H)500 mm



CONVECTION STEAM OVENS DIGITAL NANO GN-SIZE



NANO

- A convection steam oven combines the efficiency of a convection oven with the capabilities of a steam oven.
- These modes can be used separately or in conjunction with one another.
- These ovens are the way to go when you want to create scrumptious baked goods, vegetables with a bite, flavorful roasted meat and poultry or perfectly steamed fish.
- Steam is generated by directly spraying water on the heaters.
- The steam levels in the chamber are controllable and the oven has multiple automated features to maintain the set levels.
- Works with a direct water connection: 3/4", max 30°C, 150-200 kPa (2 bar), only treated, softened water.
- Housing and chamber are made of high-quality stainless steel, the chamber is equipped with a drain in the bottom.
- The powerful 6 bladed fan(s) have auto-reverse and can spin at two speeds (1400/2800 rpm), this results in ideal distribution of air in chamber and preventing inner turbulence.
- The fan motor has double bearings and 250W of power.
- The digital control panel has clear readouts for the different functions, time, temperature and cooking program.
- Electronic timer can be set up to 999 minutes, temperature up to 260°C.
- The oven is programmable to ensures the same level of quality in day to day operations.
- It's possible to create 99 3-step programs, 4 if pre-heating is also added to the program.
- The oven is fitted with a removable temperature probe which can work in conjunction with the incorporated Delta-T cooking function.
- Keeps the chamber warm before pre-heating to ensure quick ready times.
- The door is fitted with two layers of glass with space for gravity ventilation, this keeps the outside glass cool to the touch.
- Outside glass can be removed to ease cleaning.
- Door gasket is fitted in the chamber and removable to ease cleaning and replacement.
- The chamber is fitted removable GN-tray guides and halogen lighting.
- Automatic chamber heating before 'PRE-HEATING" cycle.



229477

AUTOMATIC CLEANING SYSTEM FOR NANO DRIVE OVENS AND THEIR BAKERY VERSIONS

- The system should be purchased together with an oven and installed by an authorised service/ authorised technician as the oven software has to be adjusted to the cleaning system.

code

229477



5x

GN 2/3



7x

GN 1/1



12x

GN 1/1

code	223291	223109	223086
tray support spacing	67 mm	67 mm	67 mm
external size	700x714x(H)628 mm	920x834x(H)859 mm	920x834x(H)1195 mm
number of fans with reverse	1	2	3
power/voltage	5,4 kW/400 V	10,8 kW/400 V	16,1 kW/400 V
weight	64 kg	117 kg	151 kg

FLOOR STAND

code	223666	223659	223642
dimensions	700x580x(H)700 mm	940x640x(H)700 mm	940x640x(H)500 mm



CONVECTION OVENS & COMBI-OVENS NANO 4X 450X340MM



NANO

- These ovens are the way to go when you want to create scrumptious baked goods, vegetables with a bite, flavourful roasted meats and poultry or perfectly steamed fish.
- Housing and chamber are made of high-quality stainless steel, the chamber is equipped with a drain in the bottom.
- The powerful 6 bladed fan can spin at two speeds (1400/2800 rpm), this results in ideal distribution of air in chamber and preventing inner turbulence.
- The fan motor has double bearings and 250W of power.
- Timer can be set up to 120 minutes, temperature up to 260 °C.
- The door is fitted with two layers of glass with space for gravity ventilation, this keeps the outside glass cool to the touch.
- Outside glass can be removed to ease cleaning.
- Door gasket is fitted in the chamber and removable to ease cleaning and replacement.
- Chamber capacity of 4 trays (450x340mm), tray guides are placed 75 mm apart.
- Comes with 4 baking trays.



Multi-functional manual convection oven with humidifier and grill function NANO



Convection oven manual NANO



Convection oven manual with humidifier NANO



Convection oven digital with humidifier NANO

code	223369	223376	223352	223345
	Manual control panel, three knobs for temperature, time and mode. With a humidifier button for indirect humidification.	Manual control panel, two knobs for temperature and time	Manual control panel, two knobs for temperature and time. With a humidifier button for indirect humidification.	Digital control panel, easy control over the time, temperature and humidification. The oven is programmable, possibility to create 99 3-step programs, 4 if pre-heating is added to the program.
tray support spacing	75 mm	75 mm	75 mm	75 mm
external size	560x595x(H)530 mm	560x603x(H)530 mm	560x603x(H)530 mm	560x603x(H)530 mm
number of fans	1 non-reversible fan	1 non-reversible fan	1 reversible fan	1 reversible fan
power/voltage	3,1 kW/230 V	3,1 kW/230 V	3,2 kW/230 V	3,1 kW/230 V
weight	40 kg	35 kg	38 kg	38 kg
FLOOR STAND				
code	223031	223031	223031	223031
dimensions	560x510x(H)800 mm	560x510x(H)800 mm	560x510x(H)800 mm	560x510x(H)800 mm

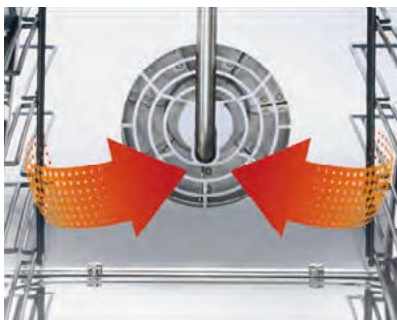



OVEN TRAY 450X340 MM

- Perfect for HENDI Nano Convection ovens & combi-ovens NANO 4x 450x340 mm
- Fits ovens 223269 223376 223345 223352.

code		mm
951569		450x340
951576	Perforated	450x340

NEW



951569

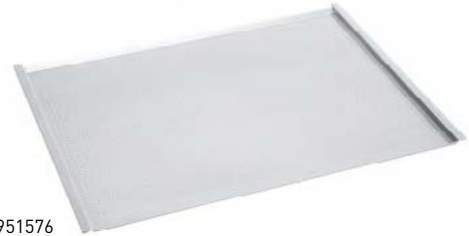

951576



OVEN GRID CHROME PLATED

- Perfect for HENDI Nano Convection ovens & combi-ovens NANO 4x 450x340 mm
- Fits ovens 223269 223376 223345 223352.

code	mm
951583	450x340

NEW



951583

HOSE WITH RINSE HEAD FOR APPLIANCES

- Ideal for any chef to keep their appliances spotless.
- Suitable for cleaning any number of waterproof appliance parts and surfaces.
- A 2 meter long hose brings many objects into range.
- Ergonomic handle with valve lever is comfortable to hold.
- Supplied with a dedicated holder that can be placed on oven housing (as indicated by technician) or on the wall using 3 screws.
- Jet is divided into a number of smaller ones using a strainer which increases the cleaning area covered.
- Water temperatures from 5°C to 85°C are ideal.
- Maximum water flow rate up to 11 L/m at pressure of 3 bar.
- Recommended supply water pressure: 3 bar.
- Operating pressure of supply water: 0.5 to 7 bar.
- PA66 nylon housing, metal parts made of chrome-plated steel.
- Water supply connection: 1/2" inner diameter.



810323

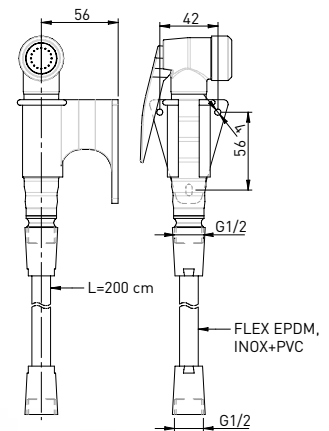

OVEN MITTS

- HENDI protective gloves are certified personal protective equipment and comply with the requirements of REGULATION (EU) 2016/425 OF THE EUROPEAN PARLIAMENT AND OF THE COUNCIL of 9 March 2016 on personal protective equipment and repealing Council Directive 89/686/EEC. The regulation defines hazard categories I through III, and for each category, methods, and certification requirements are specified. HENDI protective gloves are a category II protective equipment.
- They are CE marked as certified personal protective equipment.
- All our gloves meet the requirements of the general standard EN 420



1432X

Protection against mechanical hazards.

Gloves that protect against mechanical hazards are marked with a pictogram and numbers describing the degree of protection provided, e.g:

- The first digit indicates the abrasion resistance, the second the disc cut resistance, the third the tear resistance, and the fourth the puncture resistance.
- An additional letter at the end (from A to F) indicates the degree of cut protection depending on the force applied [from 2 N to 30 N].

Protective gloves – General requirements and test methods.

- They provide
 - thermal protection according to EN 407 Protective gloves and other hand protection against thermal risks (heat and/or fire) and
 - protection against mechanical risks according to EN 388 Protective gloves for mechanical protection, specifying levels of mechanical protection performance, and according to EN 13997 Protective clothing - mechanical properties - determination of resistance to cutting by sharp objects.



11 XXXX

Protection against thermal hazards

Gloves that protect against thermal hazards are marked with a pictogram and numbers describing the degree of protection provided, e.g:

- The first digit indicates the burning behaviour, the second resistance to contact heat, the third resistance to convection heat, and the fourth resistance to radiation heat, the fifth resistance to small splashes of molten metal, the sixth resistance to large splash of molten metal.



OVEN MITTS, COTTON - 2 PCS

code	packed per	mm
556603	2	(L)350

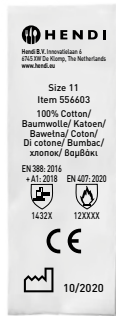

556603



OVEN MITTS, FIBERGLASS - 2 PCS

code	packed per	mm
556627	2	(L)360



556627

OVEN GLOVE HEAT RESISTANT - 2 PCS

- Heat resistant up to 250°C.
- Comfortable fit.

code	packed per	mm
556634	2	(L)300

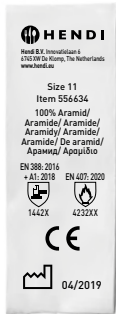

556634

OVEN MITTS, FLAME RETARDANT COTTON - 2 PCS

- Extra long to protect the forearm.
- 2 pcs.

code	packed per	mm
556610	2	(L)380

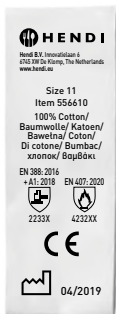

556610



CONVECTOMAT TRAYS®



20 mm outer rim around all four sides
 – allows placing the tray in point of sale displays – promotion and sale of products “directly from the tray”

Non-stick coating
 – de marmereffectcoating voorkomt aanbakken; bak met 90% minder vet/olie

The robust structure prevents undesirable deformation. The tray is positioned securely in the oven chamber's guides and is deformation-resistant

Bottom and outer walls with increased thickness of 1 mm guarantee temperature stability on the entire surface, without uneven heat distribution

Made of odourless enamelled steel – no odour emissions at high temperature ranges. Heat resistance up to 300°C

Safe coating
 – no toxins are released when baking foodstuffs in high temperatures



The tray has right angles allowing for maximum use of the finished product and easier food cost estimation, which translates into profit enabling exact portion sizes and higher return on investment

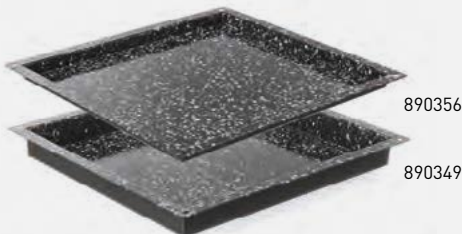

890356

890349

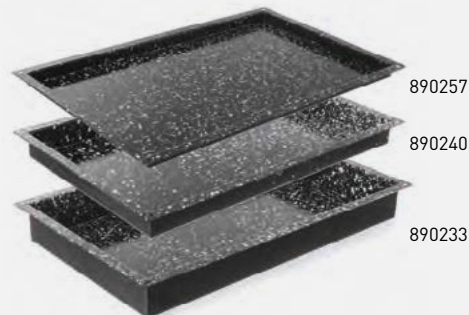

890257

890240

890233

GASTRONORM CONTAINER ENAMELLED GN 2/3

code	GN	mm
890356	GN 2/3	345x325x(H)20
890349	GN 2/3	345x325x(H)40

GASTRONORM CONTAINER ENAMELLED

code	GN	mm
890257	GN 1/1	530x325x(H)20
890240	GN 1/1	530x325x(H)40
890233	GN 1/1	530x325x(H)60





808429



TRAY GN 1/1 - WITH 4 RIMS

- With Teflon™ non-stick coating.

code	mm
808429	325x530x(H)10



808221



TRAY PERFORATED

- With Teflon™ non-stick coating.
- With 3 rims.

code	mm
808221	600x400



808207



TRAY

- With 3 rims.

code	mm
808207	600x400x(H)20



808214



TRAY PERFORATED

code	mm
808214	600x400x(H)20



808405



TRAY PERFORATED GN 1/1 - WITH 4 RIMS

- With Teflon™ non-stick coating.

code	mm
808405	530x325x(H)10



808412



TRAY PERFORATED GN 2/3 - WITH 4 RIMS

- With Teflon™ non-stick coating.

code	mm
808412	354x325x(H)10



808306



TRAY PERFORATED GN 1/1 - WITH 4 RIMS

code	mm
808306	530x325x(H)10



808313



TRAY PERFORATED GN 2/3 - WITH 4 RIMS

code	mm
808313	354x325x(H)10



808238



TRAY FOR FRENCH BREAD

- Perforated.
- Fits 5 loaves of french bread.



code	mm
808238	600x400

808245



TRAY FOR FRENCH BREAD

- With Teflon™ non-stick coating.
- Perforated.
- Fits 5 loaves of french bread.



code	mm
808245	600x400

809259



809242

GASTRONORM TRAY PROFI LINE



code	GN	mm
809259	GN 1/1	530x325x(H)20
809242	GN 1/1	530x325x(H)40

809273



GASTRONORM TRAY GN 2/3



code	mm
809280	354x325
809273	354x325

805558



805541

805534

CONTAINER WITH NON-STICK COATING



code	GN	mm
805558	GN 1/1	530x325x(H)20
805541	GN 1/1	530x325x(H)40
805534	GN 1/1	530x325x(H)65

801932



GASTRONORM GRID



code	mm
801932	354x325

801925

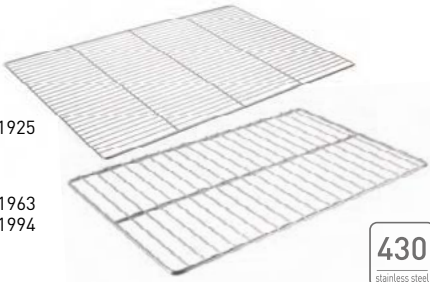

801963
801994

GRID



code	-	mm
801925	Grid transverse	600x400
801963	Chrome plated	600x400
801994		600x400

801901

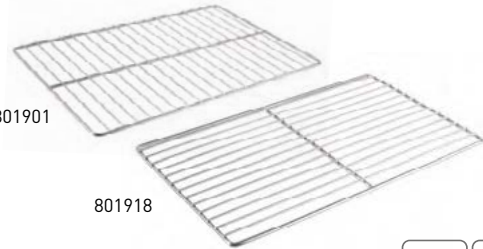

801918

OVEN GRID GN 1/1



code	-	mm
801956	Chrome plated - transverse grid	530x325
801901	Stainless steel AISI 304	530x325
801918	Stainless steel 18/10	530x325



SMOKE OVEN ELECTRIC

- The smoke oven is ideal for smoking a variety of foods such as fish, beef, ham and vegetables.
- Made of stainless steel, with a magnetically closing double-insulated door.
- Temperature adjustable with a thermostat, thermometer integrated in door.
- Equipped with a hot air vent on the rear.
- Supplied with 3 grids (400x279 mm) and 3 meat hooks.

code	V	W	mm
238486	230	1600	540x380x(H)720



238486

SMOKING CHIPS

- Made from the best wood or from the best aging barrels.
- Unique aroma.
- Chips can be placed directly over charcoal or on a smoking tray or in a smoking tube.
- Our offer includes chips made from:
 - wine, whisky, or cognac barrels.
 - oak, beech, olive, citrus, almond, or peach wood.

code	-	weight (kg)
199411	peach	0.7
199398	citrus	0.7
199404	almond	0.7
199428	red wine	0.7
199435	whisky	0.7
199367	beech	0.7
199442	cognac	0.7
199374	oak	0.7
199381	olive	0.7



199442



PIZZA OVEN

- Suitable for heating up frozen products.
- Tray grid suitable for pizzas up to ø 30 cm.
- Timer adjustable up to 15 minutes.
- With 2 heating elements (top and bottom) and crumbs tray.

code	V	W	mm
220306	230	1450	480x420x(H)195



220306



PIZZA OVENS COMPACT



- Ideal for baking pizzas, bread, lasagnas, etc.
- The compact dimensions make it perfect for small kitchens or even food trucks.
- The use of high-quality materials guarantees a long service life.
- Housing made of high-quality stainless steel AISI 430, easy to clean and maintain.
- Oven chamber measures 415x400x(H)120 mm for pizzas or other dishes.
- Chamber floor lined with chamotte stone; these accumulate the heat which results in crispy pizza bottoms.

- Each heating element is 1000 W and can be set independently from 50°C to 350°C.
- The door is fitted with a window and the chamber has a light, this allows to follow the cooking process.
- The door can be opened without stopping the heating process.
- Can operate in continuous mode or with a timer.
- Timer can be set up to 120 minutes and when the times is finished the oven stops heating.
- Fitted with ± 1.7 m long power cable with earthed plug.



220283

220290

PIZZA OVEN COMPACT

- Chamber is heated by 2 efficient heating elements; one above and one below the chamber.

code	V	W	mm
220290	230	2000	580x560x(H)275

DOUBLE DECK PIZZA OVEN 3000W

- Chambers are heated by 3 efficient heating elements; one above, one below and one in between the two chambers.

code	V	W	mm
220283	230	3000	580x560x(H)435

Chamber bottom lined with chamotte stone



Doors open forwards



Timer can be set up to 120 min



PIZZA OVEN BASIC

- Steel housing with a stainless steel front, insulated with rock wool.
- Analog control panel with individual controls for each heating element, two elements per oven chamber.
- Each oven chamber is fitted with refractory bricks, a thermometer and a light.
- Models with 2 chambers have full separate control panels for each oven chamber.
- Temperature range: 50°C up to 500°C.



226698

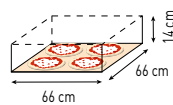

● 4 (ø32 cm)

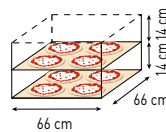

● 4+4 (ø32 cm)

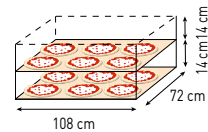

● 6+6 (ø35 cm)

name	BASIC 4	BASIC 44	BASIC XXL 66
code	226681	226698	226995
number of chambers	1	2	2
dimensions ext.	975x814x(H)413 mm	975x814x(H)745 mm	1360x844x(H)745 mm
dimensions int.	660x660x(H)140 mm	2x 660x660x(H)140 mm	2x1080x720x(H)140 mm
temperature range	from 45°C to 455°C	from 45°C to 455°C	from 45°C to 455°C
power/voltage	4,7 kW/400 V	9,4 kW/400 V	18 kW/400 V
weight	75 kg	122 kg	176 kg

FLOOR STAND

code	226797	227107	227107
dimensions	975x814x(H)960 mm	975x814x(H)860 mm	975x814x(H)860 mm

ELECTRIC DOUGH ROLLERS

- Perfect voor het rollen van pizzadeeg, pastadeeg en pastei/ravioli deeg.
- De dikte van het deeg: 1 tot 4 mm.
- Afzonderlijke roller afscherming voor eenvoudig en veilig gebruik.



Watch the video



Electric foot pedal included



code	226612	226629	226636
number of pairs of rollers	1	2	2
weight of the dough portion	0,21-0,70 kg	0,08-0,21 kg	0,21-0,70 kg
rolled dough disc diameter	ø260-450 mm	ø140-300 mm	ø260-400 mm
dimensions	650x345x(H)430 mm	475x375x(H)660 mm	585x435x(H)790 mm
power	250 W	250 W	250 W
voltage	230 V	230 V	230 V
weight	27 kg	28 kg	37 kg



226827



Stainless steel roller

CHEESE-GRATING MACHINE

- Capacity of 30 kilos per hour.
- Functional and practical, stable body.
- Despite its small size, the device offers high performance.
- Ideal for grating Parmesan cheese and other hard cheeses.
- Motor is protected against overloading.
- Provided with grated cheese container 1,3 L.
- Speed: 1400 RPM.
- Cylinder diameter Ø 110x60 mm.
- Weight 8 kg.

code	-	V	W	mm
226827	30 kg/h	230	380	280x250x(H)310



SPIRAL MIXERS

S.S. 18/10
stainless steel stainless steel

- For professional use.
- Ideal for pizzerias, bakeries, patisseries, dumplings bars, doughnut shops to mix heavy dough.
- Sturdy and robust housing made of white lacquered steel.
- The bowl, protection grid and spiral are made of AISI 304 stainless steel.
- Safety guard with a grid makes it easy to add ingredients during operation.
- With microswitch, operation stops when safety guard is lifted.
- Chain drive ensures efficient operation.
- Quiet work guaranteed thanks to oil bath gearmotor.
- The spiral design ensures perfect homogeneity and aeration of the dough.
- The mixer doesn't heat up the dough during operation.
- With built-in 30 minute timer.
- Fitted with 4 wheels of which 2 have brakes ensuring comfortable transport and easy use in the kitchen.
- 2 options to choose from: with fixed head and bowl or with rising head and removable bowl.



226209

4 wheels of which
2 have brakes



With integrated
timer

226346

Removable
bowl

SPIRAL MIXER WITH FIXED HEAD AND BOWL

code	mm	liter	weight (kg)	output (kg/h)	bowl (mm)	kg	V	W	hp
226315	290x590x(H)580	10	8	35	ø260x(H)200	40	230	370	0,5
226209	385x670x(H)725	22	17	56	ø360x(H)210	59	400	750	1,0
226308	435x750x(H)810	32	25	88	ø400x(H)260	82	400	1100	1,5

SPIRAL MIXER WITH RISING HEAD AND REMOVABLE BOWL

code	mm	liter	weight (kg)	output (kg/h)	bowl (mm)	kg	V	W	hp
226339	380x600x(H)645	10	8	35	ø260x(H)200	56	230	370	0,5
226346	390x670x(H)735	22	17	56	ø360x(H)210	81	400	750	1,0
226353	435x750x(H)810	32	25	88	ø400x(H)260	95	400	1100	1,5





224830



PASTA MAKER

- Perfect for making fresh pasta (max. width: 140 mm).
- Dough thickness adjustable in 7 steps from 0,2 to 2,5 mm.
- Three aluminium alloy rollers/cutters: dough roller, tagliatelle cutter and fettuccine cutter.
- Includes a hand crank and a clamp for table mounting.

code	mm
224830	382x440x(H)340



PASTA MAKER ELECTRIC

- Perfect for making fresh pasta (max. width: 170 mm).
- Cover equipped with safety switch.
- Dough thickness adjustable in 7 steps from 0,2 to 2,5 mm.
- Three rollers/cutters: dough roller, tagliatelle cutter (6,25 mm) and fettuccine cutter (2 mm). The rollers and cutters are made of 430 stainless steel.

code	V	W	mm
224847	230	70	258x218x(H)232



Watch the video



224847

PIZZA DOUGH BOX

- Made of food-grade polypropylene, harmless to human health.
- It maintains freshness of dough and continuity of proofing process.
- Stackable – with or without lids.
- Dishwasher safe.

WHAT SHOULD AN IDEAL PIZZA DOUGH PROOFING BOX BE?

Airtight

One of the most key features to look out for is whether your dough proofing box is airtight. This prevents the dough from drying out during prolonged fermentation and makes the dough easier to form.

Environmentally friendly

The use of airtight, resealable boxes reduces the use of foil, traditionally used to cover the dough during proofing. Plastic boxes are durable and can last for many years.

Made of suitable material

Traditional Italian dough proofing boxes were made of wood, but modern plastic boxes provide several benefits. They are airtight and they improve the shape and structure of the dough balls. The right amount of time for the dough to proof creates the right structure which translates into comfortable work – the dough is easier and quicker to stretch. This is not possible with metal containers that interfere with the dough proofing process.

The plastic surface is also smooth, which prevents the dough balls from sticking and makes it easy to remove them from the box after proofing.

Stackable

During proofing and fermentation, we keep multiple balls of dough at the same time. Stackable boxes take up less space in the kitchen. Stacked boxes are also easier to handle due to their stability.

No rounded edges

Special pizza dough boxes make it easy to cut and pull the dough without misshaping it. GN containers, which are used in kitchens, have rounded edges, thus making it impossible to remove the dough balls without destroying their shape.



880906



KITCHEN LINE PIZZA DOUGH BOX

code	liters	mm int.	mm
880906	14	565x365x(H)70	600x400x(H)75
880913	18	565x365x(H)90	600x400x(H)95
880920	24	565x365x(H)125	600x400x(H)130
880968		lid	600x400



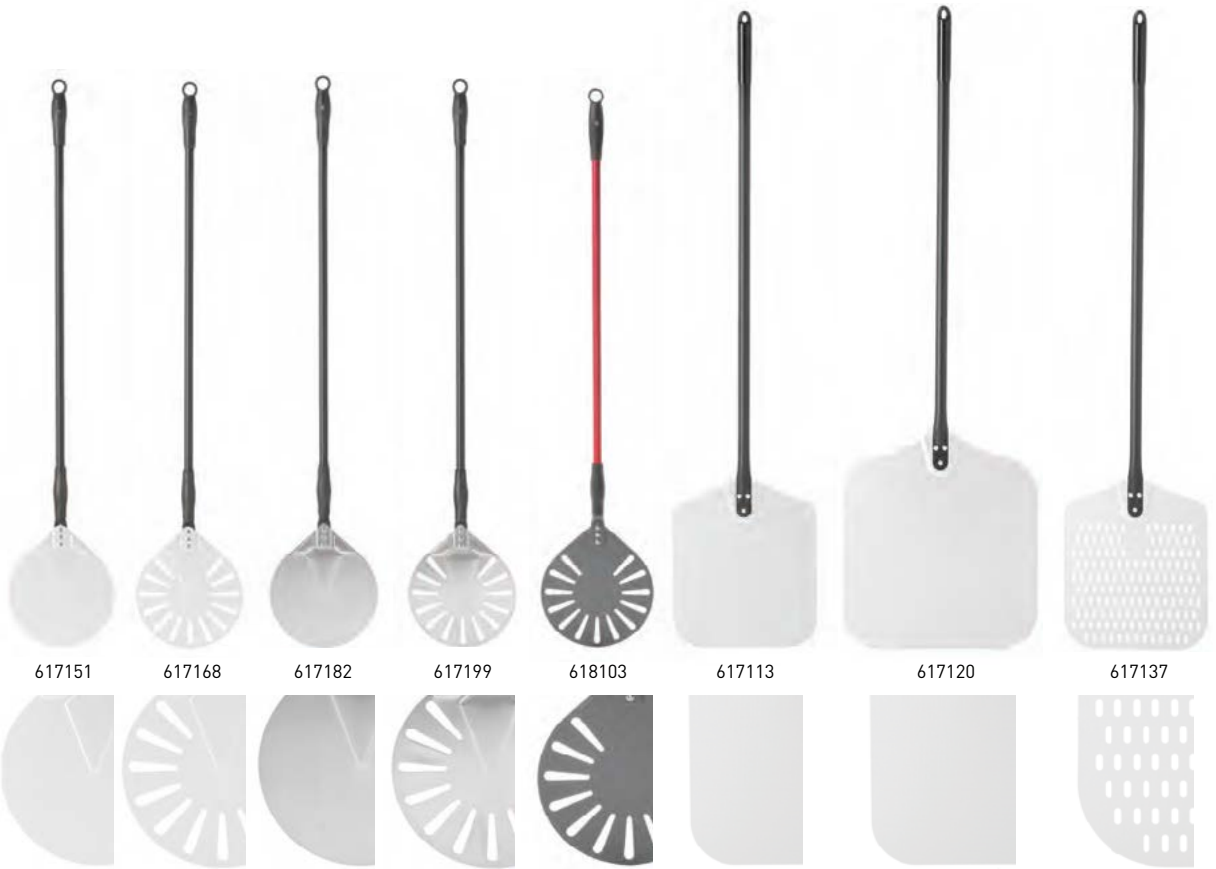

617151

617168

617182

617199

618103

617113

617120

617137

PIZZA SCOOP

- Lightweight and durable, made of anodized aluminium.
- Handle with slide grip for easy removal of pizzas from the oven.



code		mm
617151	-	230x1200
617168	perforated	230x1200

PIZZA SCOOP, ROUND, PERFORATED

- Made from hard anodised aluminium, making it more wear-resistant, abrasion-resistant and corrosion resistant.
- With sliding grip, which doubles as heat insulation.



code		mm
618103	perforated	230x1200

PIZZA SCOOP ROUND

- Handle with slide grip for easy removal of pizzas from the oven.



code		mm
617182	-	230x1200
617199	perforated	230x1200

PIZZA SCOOP SQUARED

- Light and robust, made of anodised aluminium.



code		mm
617113	-	305x1320
617137	perforated	305x1320
617120	-	405x1320
617144	perforated	405x1320



523902



CAKE SERVER

- With polypropylene handle.

code	mm
523902	260x55



523957



CAKE SCOOP/CUTTER

- Black polypropylene handle.
- Thanks to its sharpened edges it can be used as a knife.

code	mm
523957	300x75



617144



617175



617861



617816



525593



525630



PIZZA SCOOP SQUARED



code	mm
617175	305x1320

PIZZA OVEN CLEANING BRUSH

- Copper brush with aluminium handle.



code	mm
525593	(L)1320

PIZZA SCOOP, SQUARED

- For use in pizzerias and regular restaurants
- Long wooden handle
- Aluminium head
- Heat resistant



code	mm
617816	305x1320
618028	355x1320
617861	405x1320

PIZZA OVEN CLEANING BRUSH

- Brush made of brass wire.
- Steel scraper.
- Removable wooden handle with a screw.

code	mm
525630	930x260

PIZZA SCOOP, WOODEN

- Can be used when removing pizza from the oven and for serving.
- Made of durable wood, resistant to high temperatures.

code	mm
617724	535x305x(H)10



617724



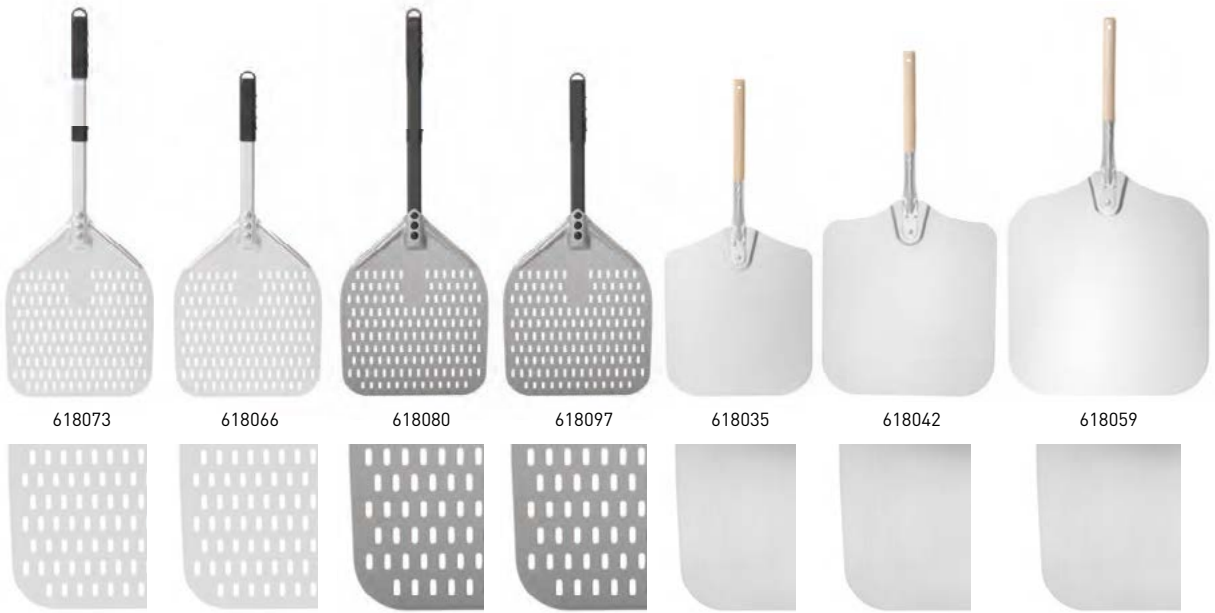

PIZZA SCOOP WITH SHORT HANDLE, SQUARED, PERFORATED

- Ideal for use in small spaces
- Made of anodised aluminum
- Lightweight and durable
- Perforation to drain excess flour
- Short handle
- Non-heating silicone handle

PIZZA SCOOP WITH SHORT HANDLE, SQUARED, PERFORATED

- Made from hard anodised aluminium, making it more wear-resistant, abrasion-resistant and corrosion resistant.
- Fitted with a short handle, ideal for compact spaces.
- The silicone handle remains cool during use and protects against heat.

PIZZA SCOOP SQUARED WITH SHORT HANDLE

- Ideal for small spaces
- Short wooden handle
- Aluminium head
- High Thermal Resistance

code	mm
618073	300x660
618066	350x710

code	mm
618080	350x710
618097	300x660

code	mm
618035	305x660
618042	355x710
618059	405x760



617007



PIZZA SLICER

- Stainless steel knife blade, polypropylene handle.

code	ø	length (mm)
617007	ø100	(L)230



617014



PIZZA SLICER

- Stainless steel knife blade, polypropylene handle.
- With HACCP color coding system, coloured clips are not removable after placing.

code	ø	length (mm)
617014	ø100	(L)230

PIZZA PLATES SPECIALE

- Made of very durable porcelain, these plates are perfect for heavy use in professional catering establishments.
- The snow-white plates are available in sizes with the diameter of 28 and 33 cm and are complemented with elements in trendy colours;

- they go together perfectly and bring out the appearance of the dish, making it look even tastier.
- The decoration is protected by glaze, which makes the plates dishwasher and microwave safe.



774847

PIZZA PLATE SPECIALE

code	order unit	mm
774830	6	ø280
774847	6	ø330



774892

PIZZA PLATE SPECIALE DECORATED

code	order unit	mm
774892	6	ø330



774885

PIZZA PLATE SPECIALE GRANITE

code	order unit	mm
774885	6	ø330



774861

PIZZA PLATE SPECIALE YELLOW

code	order unit	mm
774861	6	ø330



774854

PIZZA PLATE SPECIALE GRAY

code	order unit	mm
774854	6	ø330



774878

PIZZA PLATE SPECIALE ORANGE

code	order unit	mm
774878	6	ø330



777855

PIZZA PLATE SPECIALE BAROCCO

code	mm
777855	ø330





617069

PIZZA PAN

- Made of blue steel.
- Ideal for uniform pizza baking.
- Pan thickness: 0.75 mm
- Suitable for using in a wood-burning oven.

code	mm
617069	ø200x(H)25
617076	ø220x(H)25
617083	ø240x(H)25
617090	ø260x(H)25
617106	ø280x(H)25
617205	ø300x(H)25
617304	ø320x(H)25
617403	ø360x(H)25
617410	ø400x(H)25
617427	ø450x(H)38
617434	ø500x(H)38



617533

PIZZA SCREEN

- Ideal for uniform pizza baking.
- Made of aluminium.

code	mm
617502	ø230
617519	ø250
617526	ø280
617533	ø300
617540	ø330
617557	ø360
617458	ø380
617564	ø400
617465	ø430
617571	ø450
617588	ø508
617595	ø600



505533

500040



PIZZA BOARD WITH HANDLE

- Made of compressed wood fibers.
- Resistant to temperature of up to 175 °C.
- The high pressure used during production makes the boards stronger than regular wood.
- Maintenance free (no need for oil or bleach).
- Handle with hole to hang the board.
- Darkens during use which gives it a natural look.

code	mm
505533	ø305x(H)6
500040	ø356x(H)6
500057	ø406x(H)6



LID SPACER FOR PIZZA'S - 500 PCS

- Height of the lid spacer: 35 mm.

code	packed per
709900	500



709900



PERFORATED PIZZA PAN

- For use in restaurants, canteens and hotels serving pizza.
- The pizza screen is made of carbon steel covered with iron oxide which ensures excellent corrosion protection.
- Even baking thanks to special sheet perforation.
- Holes measuring: Ø 3mm.
- Heat resistance up to: 420°C.
- Food contact safe.
- Suitable for oven use.
- ATTENTION: Not dishwasher safe nor microwave safe.

code	mm
616918	ø280x(H)25
616901	ø260x(H)25
616925	ø300x(H)25
616932	ø340x(H)25
616949	ø400x(H)25



617700



PAN GRIPPER

- Suitable for all types of pizza pans.

code	mm
617700	(L)190

NEW



616918



617731



PAN GRIPPER

- Suitable for all types of pizza pans.

code	mm
617731	(L)200



505540



ø500 and 600 mm have a reinforced bottom



PIZZA BOARD

- Made of raw beech wood.
- With grooves to assist cutting into 6 equal parts.

code	mm
505540	ø300
505557	ø350
505564	ø400
505571	ø450
505588	ø500



810361



PIZZA SCREEN/PAN RACK

- Holds up to 14 pizza screens or pans.

code	mm
810361	300x305x(H)680



709887



709870

PIZZA DELIVERY BAG 35 CM KITCHEN LINE

- Made from durable and easy to clean polyester.
- Outside made from 600D polyester and the inside is made from 210D polyester.
- Pizza compartment is padded with 5 mm thick foam.
- Closed with velcro, easy to adjust.
- The large handle makes carrying comfortable.
- Fitted with top transparent pocket for bills.

code	mm
709887	370x370x(H)210

PIZZA DELIVERY BAG 45 CM KITCHEN LINE

- Made from durable and easy to clean polyester.
- Outside made from 600D polyester and the inside is made from 210D polyester.
- Pizza compartment is padded with 5 mm thick foam.
- Closed with velcro, easy to adjust.
- The large handle makes carrying comfortable.
- Fitted with top transparent pocket for bills.

code	mm
709870	470x470x(H)210



709818

PIZZA DELIVERY BAG 35 CM

- Tight shutter easy to adjust.
- Made of tough and easy to clean material.
- Top transparent pocket for bills.

code	capacity	mm
709825	4 boxes	360x360x(H)200
709818	4 boxes	460x460x(H)210



WATERPROOF COATING

The bag is made of a high-quality material that protects its contents against water and wind.
EASY DELIVERY EVEN WHEN IT RAINS OR SNOWS



HENDI



UNIQUELY CAPACIOUS INTERIOR

The bag has a capacity of 72 litres, which means that you can deliver up to: 10 pizza boxes* or 8 salads* + 6 main courses* + 6 soups*
HIGH CAPACITY = HIGH PERFORMANCE = LOWER COST OF DELIVERY = HIGHER PROFIT
* standard delivery packaging was used for the measurement.

ADJUSTABLE THERMAL SHELF

A shelf that divides the compartment into two parts.
Select a place for salads, coleslaws. Put hot dishes in a separate compartment. COOL AT THE BOTTOM, HOT AT THE TOP

SEPARATORS

The thermal bag has 5 semicircular separators in the lower shell. They provide thermal insulation of the container compartment from the ground and prevent the outer fabric from becoming worn out. DON'T WORRY ABOUT PUTTING IT DOWN THE DISHES ARE SAFE



MULTIFUNCTIONAL CARRIER

Equipped with:

- Chest + belt tensioners
- Hooks for payment terminals/on the straps
- Comfort system – soft, ventilated cladding with light foam on the back and the harness
- Waterproof bill pocket

FUNCTIONALITY COMFORT "HANDS-FREE"

THREE-LAYER WALL WITH COMPARTMENT INSERT

Low temperature permeability thanks to the multi-layer system of walls where the PVC compartment insert plays an important role. It stiffens the entire structure and provides effective thermal insulation. THE THERMO INSTANT TECHNOLOGY KEEPS THE FOOD WARM FOR MORE THAN 1.5 HOURS

STRUCTURAL AND SUPPORT BELTS IN AUTOMOTIVE TECHNOLOGY

Polypropylene weave strips in the belt. Durable, strong, with a great design that will last for years. NO FRAYING OR UNRAVELLING

PIZZA & FOOD DELIVERY BACKPACK INSULATED

- Lightweight backpack with large, adjustable, padded shoulder straps and padded back section for comfort.
- Fitted with adjustable waist band for extra stability.
- Waterproof thanks to the use of durable 600D polyester.
- Large compartment with adjustable, velcro mounted shelf.
- Compartment has two layers of insulation, PE foam and aluminium foil.

- One side of the backpack can be opened with a zipper for easy access.
- With large padded carrying handles on the top and a transparent card holder on the back.
- Reflector strip fitted on the outside for extra safety.

code	mm
709801	410x410x(H)480

PROFI LINE | 800 SERIES ARKTIC

Arctic
REFRIGERATION SINCE 1952



- Inner and outer housing are made of high-quality stainless steel, except the outer rear cover which is made of galvanized steel.
- Self-closing lockable door(s) with comfortable curved door handle(s).
- Forced air cooling with auto-defrost, compressor placed above the chamber.
- 60 mm thick polyurethane foam insulation.

- With adjustable shelving, fits containers up to GN 2/1.
- Digital display and electronic thermostat.
- Fitted with 4 wheels of which 2 are castor wheels.
- Climate class: 5.



Watch the video

232118
232132



Chamber and outer housing made of stainless steel

SET OF 4 FEET FOR REFRIGERATORS AND FREEZERS

- 4 stainless steel feet, adjustable up to 60 mm
- Diameter: 55 mm
- For Profi Line and Kitchen Line refrigerated and freezer cabinets

code

941072



232125
232149



type	cooling, 1-door	freezing, 1-door	cooling, 2-door	freezing, 2-door
code	232118	232132	232125	232149
capacity	670 l	670 l	1240 l	1240 l
dimensions	730x805x(H)1940 mm	730x805x(H)1940 mm	1314x805x(H)1940 mm	1314x805x(H)1940 mm
chamber dimensions	610x635x(H)1540 mm	610x635x(H)1540 mm	1194x635x(H)1540 mm	1194x635x(H)1540 mm
range	0/8°C	-22/-17°C	0/8°C	-22/-17°C
coolant	R600a (110 g)	R290 (120 g)	R600a (140 g)	R290 (150 g)
energy class	B	C	B	C
shelves	4 x GN 2/1 (650x530 mm)*	4 x GN 2/1 (650x530 mm)*	4+4 x GN 2/1 (650x530 mm)*	4+4 x GN 2/1 (650x530 mm)*
average daily power consumption	1,26 kW	4,99 kW	2,01 kW	8,19 kW
power/voltage	220 W/230 V	600 W/230 V	350 W/230 V	980 W/230 V
weight	107 kg	115 kg	171 kg	177 kg
SHELF GN 2/1	936191	936191	936191	936191

* Maximum load capacity of the shelf approx. 40 kg (with evenly distributed load)

Fitted with wheels



Dynamic forced cooling



Self-closing, lockable door



REFRIGERATOR & FREEZER COUNTERS PROFI LINE | 700 SERIES



- Inner and outer housing are made of high-quality stainless steel, except the outer rear cover which is made of galvanized steel.
- Self-closing doors fitted with comfortable handles.
- Work surface fitted with a 40 mm high ridge at the back (except 233764).
- Forced air cooling with auto-defrost, compressor placed next to the chamber.
- 50 mm thick polyurethane foam insulation.
- With adjustable shelving, fits containers up to GN 1/1.
- Digital display and electronic thermostat.
- With 4 adjustable stainless-steel feet.
- Climate class: 5 (232040, 232057), 4 (232064, 232699).



Chamber and outer housing made of stainless steel



232040
232064

4 SHELVES INCLUDED



233764



232057
232699

6 SHELVES INCLUDED



232071

DRAWER WITH RAILS - 2-PIECE SET

code	mm
232071	300x545x(H)145

	A A G	B A G	C A G	A A G	C A G
type	cooling, 2-door	cooling, 4-door	freezing, 2-door	cooling, 3-door	freezing, 3-door
code	232040	233764	232064	232057	232699
capacity	280 l	280 l	280 l	420 l	420 l
dimensions	1360x700x(H)850 mm	1360x700x(H)850 mm	1360x700x(H)850 mm	1795x700x(H)850 mm	1795x700x(H)850 mm
chamber dimensions	822x570x(H)580 mm	822x570x(H)580 mm	822x570x(H)580 mm	1257x570(H)580 mm	1257x570(H)580 mm
range	0/8°C	0/8°C	-22/-17°C	0/8°C	-22/-17°C
compressor	EMT65HLR power 1/4 KM	EMT65HLR power 1/4 KM	EGU130HLR power 1/2 KM	EGAS100HLR power 1/3 KM	NEK2140Z power 2/3 KM
coolant	R600a (120 g)	R600a (120 g)	R290 (140 g)	R290 (130 g)	R290 (140 g)
energy class	A	B	C	A	C
shelves	2+2 x GN 1/1*	4 drawers	2+2 x GN 1/1*	2+2+2 x GN 1/1*	2+2+2 x GN 1/1*
average daily power consumption	1,34 kW	1,34 kW	3,97 kW	1,73 kW	5,09 kW
power/voltage	250 W/230 V	250 W/230 V	600 W/230 V	400 W/230 V	600 W/230 V
weight	95 kg	95 kg	95 kg	120 kg	120 kg
SHELF	941058		941058	941058	

* Maximum load capacity of the shelf approx. 40 kg (with evenly distributed load)

KITCHEN LINE | 600 SERIES



- Inner and outer housing are made of high-quality stainless steel Self-closing doors fitted with comfortable handles.
- Work surface fitted with a 40 mm high ridge at the back.
- Static refrigeration supported by internal fan, pollen filter.
- Forced air cooling with auto-defrost, compressor placed underneath the chamber.
- 50 mm thick polyurethane foam insulation.

- With adjustable shelving.
- Digital display and electronic thermostat.
- With 4 adjustable stainless-steel feet.
- Climate class: 5 (233344, 233382), 4 (233351, 233399).
- Coolant: R600a (233344, 233382), R290 (233351, 233399).



233344
233351

233382
233399



type	cooling, 2-door	freezing, 2-door	cooling, 3-door	freezing, 3-door
code	233344	233351	233382	233399
capacity	220 l	220 l	390 l	390 l
dimensions	1200x600x(H)850 mm	1200x600x(H)850 mm	1800x600x(H)850 mm	1800x600x(H)850 mm
chamber dimensions	800x480x(H)580 mm	800x480x(H)580 mm	1400x480x(H)580 mm	1400x480x(H)580 mm
range	0/8°C	-22/-17°C	0/8°C	-22/-17°C
compressor	EMT65HLR power 1/4 KM	NE2134Z-263CA power 1/2 KM	FFI10HAK power 1/3 KM	NEK2140GZ-269GA power 1/2 KM
coolant	R600a (100 g)	R290 (90 g)	R600a (100 g)	R290 (90 g)
energy class	B	C	B	C
climate class	5	4	5	4
shelves	1+1 x 390x428 mm*	1+1 x 390x428 mm*	2x 430x428 mm + 1x 490x428 mm*	2x 430x428 mm + 1x 490x428 mm*
average daily power consumption	2,06 kW	4,5 kW	2,36 kW	5,48 kW
power/voltage	270 W/230 V	550 W/230 V	270 W/230 V	550 W/230 V
weight	74 kg	74 kg	100 kg	100 kg
SHELF	949276	949276	954775	956113
			Left or right	Middle
				Left or right
				Middle

* Maximum load capacity of the shelf approx. 15 kg (with evenly distributed load)

Electronic temperature controller



Forced air cooling



Shelve placing adjustable



KITCHEN LINE | 700 SERIES

- Inner and outer housing are made of high-quality stainless steel.
- Doors fitted with comfortable handles.
- Forced air cooling with auto-defrost, compressor placed underneath the chamber.
- 35 mm thick polyurethane foam insulation.
- With adjustable shelving, fits containers up to GN 1/1.
- Digital display and electronic thermostat.
- With 4 adjustable plastic feet.
- Auto-defrost with condensation evaporator.
- Climate class: SN-T.
- Coolant: R600a.



Chamber and outer housing made of stainless steel



232019



232026

type	cooling, 2-door	cooling, 3-door
code	232019	232026
capacity	300 l	380 l
dimensions	900x700x(H)880 mm	1365x700x(H)880 mm
chamber dimensions	830x595x(H)500 mm	1295x595x(H)500 mm
range	-2/8°C	-2/8°C
coolant	R600a	R600a
energy class	A	A
shelves	2 shelves (335x570 mm)	3 shelves (335x570 mm)
power/voltage	220 W/230 V	220 W/230 V
weight	70 kg	91 kg
SHELF	931561	931561

Shelve placing adjustable



Comfortable handles



Electronic temperature controller



SALAD COUNTERS

- Inner and outer housing are made of high-quality stainless steel.
- Doors fitted with comfortable handles.
- Forced air cooling with auto-defrost, compressor placed underneath the chamber.
- 35 mm thick polyurethane foam insulation.
- With adjustable shelving, fits containers up to GN 1/1.



- Digital display and electronic thermostat.
- With 4 adjustable plastic non-slip feet.
- Climate class: SN-T.
- Coolant: R600a.
- All models delivered without GN containers.



232781



232798



232880

Chamber and outer housing made of stainless steel



COOLING

type	Two door salad counter with glass display	Three door salad counter with glass display	Two door salad counter with raised GN display
code	232781	232798	232880
	With stylish glass display, covers space for 2x GN 1/1 and 3x GN 1/6 containers (max. height 150 mm)	With stylish glass display, covers space for 4x GN 1/1 containers (max. height 150 mm)	With stainless steel lid which covers space for 5x GN 1/6 containers (max. height 150 mm) GN display dimensions: 900x265x(H)195 mm
capacity	300 l	380 l	300 l
dimensions	900x700x(H)1300 mm	1365x700x(H)1300 mm	900x700x(H)1055 mm
chamber dimensions	830x595x(H)500 mm	1295x595x(H)500 mm	830x595x(H)500 mm
range	-2/8°C	-2/8°C	-2/8°C
coolant	R600a	R600a	R600a
shelves	2 shelves (335x570 mm)	3 shelves (335x570 mm)	2 shelves (335x570 mm)
power/voltage	310 W/230 V	310 W/230 V	270 W/230 V
weight	80 kg	110 kg	100 kg
SHELF	956403	956403	956403

Shelve placing adjustable



Comfortable handles





232897



232804



232811



Three door salad counter with raised GN display

232897

With stainless steel lid which covers space for 8x GN 1/6 containers (max. height 150 mm)
GN display dimensions: 1365x265x(H)195 mm.

380 l

1365x700x(H)1055 mm

1295x595x(H)500 mm

-2/8°C

R600a

3 shelves (335x570 mm)

310 W/230 V

105 kg

956403



Two door salad counter

232804

With stainless steel lid which covers space for 2x GN 1/1 and 3x GN 1/6 containers (max. height 150 mm)

Plastic work counter: 900x135x(H)20 mm

300 l

900x700x(H)888 mm

830x595x(H)500 mm

-2/8°C

R600a

2 shelves (335x570 mm)

310 W/230 V

68 kg

931561

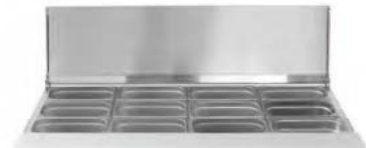

Three door salad counter

232811

With stainless steel lid which covers space for 4x GN 1/1 containers (max. height 150 mm)

Plastic work counter: 1365x135x(H)20 mm

380 l

1365x700x(H)888 mm

1295x595x(H)500 mm

-2/8°C

R600a

3 shelves (335x570 mm)

310 W/230 V

87 kg

956403

Electronic temperature controller



PIZZA COUNTERS



- Inner and outer housing are made of high-quality stainless steel, with granite worktop.
- Doors fitted with comfortable handles.
- Forced air cooling with auto defrost, compressor placed underneath the chamber.
- With adjustable shelving, fits containers up to GN 1/1.
- Digital display and electronic thermostat.
- With 4 adjustable plastic non-slip feet.
- Climate class: SN-T.
- Coolant: R600a.
- All models delivered without GN containers.



Chamber and outer housing made of stainless steel



232859



232873

Two door pizza counter 300L

Three door pizza counter 380L

code	232859	232873
	With stainless steel cover around the GN space which fits 5x GN 1/6 containers (max. height 150 mm)	With glass cover around the GN space which fits 8x GN 1/6 containers (max. height 150 mm).
capacity	300 l	380 l
dimensions	900x700x(H)1100 mm	1365x700x(H)1120 mm
chamber dimensions	830x595x(H)500 mm	1295x595x(H)500 mm
range	-2/8°C	-2/8°C
coolant	R600a	R600a
shelves	2 shelves (335x570 mm)	3 shelves (335x570 mm)
power/voltage	310 W/230 V	220 W/230 V
weight	94 kg	180 kg
SHELF	931561	956403

COOLING



PIZZA COUNTERS

- Inner and outer housing are made of high-quality stainless steel, with granite worktop.
- Doors fitted with comfortable handles.
- Forced air cooling with auto defrost, compressor placed underneath the chamber.
- With adjustable shelving, fits containers up to GN 1/1.
- Digital display and electronic thermostat.
- With 4 adjustable plastic non-slip feet.
- Climate class: SN-T.
- Coolant: R600a.
- All models delivered without GN containers.



232996

2-DOOR PIZZA COOLING TABLE WITH 7 DRAWERS, WITH GRANITE WORKTOP

- Equipped with 7 uncooled drawers of 400x620x(H)65 mm.
- Chamber dimensions: 1480x670x(H)570 mm.
- 60 mm thick polyurethane foam insulation.
- 2 shelves (600x400mm) included.
- Spread load capacity of 15 kg each.
- Energy label (counter only): A (A+++G).
- Weight: 367 kg.



code	range	V	W	mm
232842	-2/8°C	230	250	2010x800x(H)1000



232842



THREE DOOR PIZZA COUNTER WITH COOLING DISPLAY 380+40L

- Chamber capacity: 254 l.
- Chamber dimensions: 1295x595x(H)475 mm.
- Includes 3 shelves 335x570 mm, maximum load capacity 15 kg (with evenly distributed load).
- Cooling top unit with static cooling.
- Cooling top unit for 6x GN 1/4, dimensions 1405x335x(H)435 mm.
- Climate class: table: 4, cooling top unit: 5.
- Refrigerant: R600a (70 g + 40 g).
- Average daily electricity consumption: 1.6 kW (table), 1.55 kW (top unit).
- Self-closing door.
- Energy label (counter only): A (A+++G).
- Weight: 193+41 kg.

code	range	V	W	mm
232033	-2/8°C	230	400	1365x700x(H)1030



Chamber and outer housing made of stainless steel



232033

SHELF FOR COUNTER REFRIGERATOR & FREEZERS 2-DOORS KITCHEN LINE

code
931561

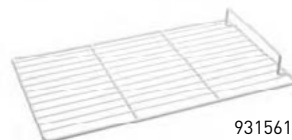

931561



REFRIGERATED COUNTERTOP SERVER

- Inner and outer casing made of high-grade stainless steel
- Static cooling – cooled bottom of the inner basin
- EMBRACO refrigeration unit
- Insulation thickness: 40 mm (material: C5H10)
- Digital display, electronic thermostat
- Climate class: 5
- Refrigerant: R600a (40 g)
- Average daily electricity consumption: 1.55 kW
- Temperature range: 0/8°C
- Compressor: EMT45HLR with 1/5 hp
- Automatic defrosting
- Smooth operation in ambient temperature of up to 32°C and relative humidity up to 60%
- 4 plastic feet



232965

4x GN 1/3



232903

5x GN 1/4



232972

6x GN 1/3



232910

7x GN 1/4



232989

7x GN 1/3



232927

8x GN 1/4



232996

9x GN 1/3

REFRIGERATED COUNTERTOP SERVER GN 1/4 ARKTIC

- With hardened glass display.
- Fits GN 1/4 containers with a max height of 150 mm.

code	-	V	W	mm
232903	5x GN 1/4	230	180	1205x335x(H)430
232910	7x GN 1/4	230	180	1505x335x(H)430
232927	8x GN 1/4	230	180	1805x335x(H)430

REFRIGERATED COUNTERTOP SERVER GN 1/3 ARKTIC

- With hardened glass display.
- Fits GN 1/3 containers with a max height of 150 mm.

code	-	V	W	mm
232965	4x GN 1/3	230	180	1205x395x(H)430
232972	6x GN 1/3	230	180	1405x395x(H)430
232989	7x GN 1/3	230	180	1605x395x(H)430
232996	9x GN 1/3	230	180	2005x395x(H)430

REFRIGERATED COUNTERTOP SERVER GN 1/3 ARKTIC

- With stainless steel lid.
- Fits GN 1/3 containers with a max height of 150 mm.

code	-	V	W	mm
233948	4x GN1/3	230	180	1205x395x(H)290
233955	6x GN1/3	230	180	1405x395x(H)290
233979	7x GN1/3	230	180	1605x395x(H)290
233986	8x GN1/3	230	180	1805x395x(H)290
233993	9x GN1/3	230	180	2005x395x(H)290



233948





NEW

DRY AGING CABINET

- Body, door frame, and door handle made of AISI 304 stainless steel.
- Door made of 2 layers of Low-E tinted tempered glass which increases energy efficiency by blocking infrared light and UV from the outside while preventing the heat from transferring inside. Door lock is included.
- Distilled water container made of ABS – distilled water must be filled manually.
- Notification on display and audible alarm to warn when humidity is below 15% for the user to fill the water container.
- Alarm indicating the door open for more than 3.5 minutes – protection against uncontrolled disruption of the conditions in the chamber.
- In the cabinet there are:
 - 3 shelves,
 - 1 hanging rod,
 - 3 hooks,
 - salt tray (salt not included),
- all elements above are made of AISI 304 stainless steel.
- Built-in UVC sterilisation lamp to prevent bacterial growth and guarantee safe environment for the meat; when the door is opened during the seasoning process, bacteria do not have a chance to develop.
- Cooling by means of an evaporator and a ventilator which ensures the required level of air circulation.
- LED lights placed on both sides of the chamber and on the ceiling.
- Max. load per shelf: 30 kg.
- Max. load per hook: 25 kg.
- Max. load of the hanging rod: 50 kg.
- Temperature range: 1-25 °C.
- Adjustable humidity range: 60-85%.
- Current humidity level is displayed on the panel.
- Refrigerant: R600a.

code	liters	V	W	mm
204962	352	230	170	595x710x(H)1720



204962



Blast chilling from +90°C to +3°C

This process helps lower the food temperature to safe +3°C in a suitably short time, in line with HACCP standards.

The adequate chilling speed helps reduce bacteria growth in the range from +65°C to +10°C.

Blast chilling helps retain the quality, colour and smells of food and extends the storage period.

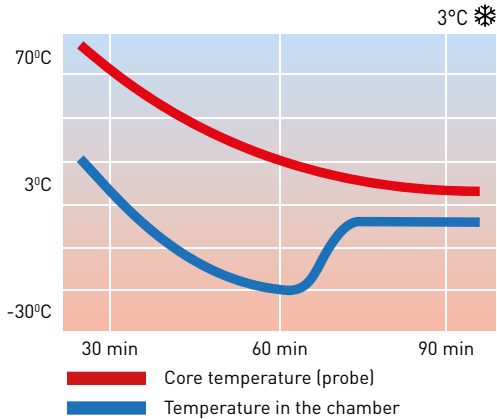

Blast freezing from +90°C to -18°C

Powerful chilling system and blowing air of -40°C into the chamber makes the core temperature of food quickly drop to -18°C.

It prevents large ice crystals from occurring, which damage the internal structure of food.

Blast freezing results in a large number of small crystals which preserves the original properties of food: flavour, colour, texture and nutrients, and helps extend the storage period.

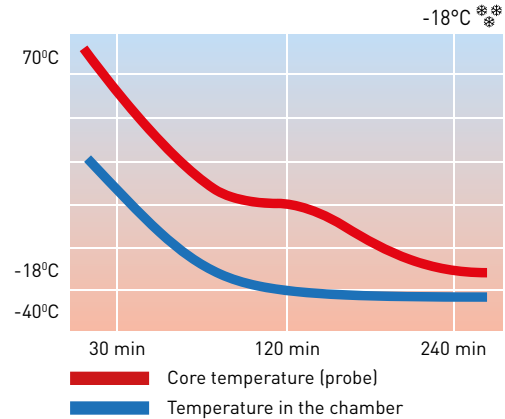

Arktic ❄️
ESTABLISHED SINCE 1982



BLAST CHILLER 3X GN 2/3

- For quick cooling or freezing of prepared food, freezing cakes, desserts, fish or ice cream.
- Stainless steel exterior and chamber interior, galvanized steel base.
- Chamber with rounded internal corners for easy cleaning.
- 3 stainless steel guides suitable for GN 2/3.
- 60 mm polyurethane insulation, injected under high pressure.
- Self-sealing door with left hand hinges and magnetic seal.
- Front panel with electronic control and display.
- Easy access to capacitor for cleaning and maintenance.
- Manual defrosting with door open.

- Removable drip tray.
- Distance between guides: 80 mm.
- Cooling capacity at 9kg: (+65°C/+3°C) in max. 90 min.
- Freezing capacity at 7kg: (+65°C/-18°C) in 240 min.
- Cooling Agent: R455.
- Fan forced cooling.
- Chamber and Core Probe Included.
- Adjustable feet (up to 20 mm).

code	V	W	mm
237731	230	550	660x640x(H)420

BLAST CHILLERS

- Enables quick chilling or freezing of prepared dishes.
- Chilling from 70°C to 3°C (90 mins), from 70° C to -18°C (240 mins) or within a pre-set time (without indicating the target temperature).
- Outer housing and inner chamber made of high-quality stainless steel.
- Inner chamber with rounded corners for easier cleaning.
- Forced air cooling with auto-defrost, compressor placed underneath the chamber.
- 60 mm thick polyurethane foam insulation.



- Removable top cover.
- Self-closing door with magnetic gasket.
- Digital temperature controller and display.
- Probe included.
- Fitted with 4 adjustable stainless steel feet.
- Climate class: SN-T
- Coolant: R455.

Chamber and outer housing made of stainless steel



232163



232170



232187

code	chamber capacity	tray support spacing (mm)	output at chilling to +3°C (kg/cycle)	output at freezing to -18°C (kg/cycle)	V	W	inside dimensions of the chamber (mm)	mm	kg
232163	3x GN 1/1 or 3x 600x400	70	14	11	230	1150	610x410x(H)280	750x740x(H)750	50
232170	5x GN 1/1 or 5x 600x400	70	20	15	230	1420	610x410x(H)410	750x740x(H)880	71
232194	7x GN 1/1 or 7x 600x400	105	25	20	230	1490	610x410x(H)760	750x740x(H)1290	90
232187	10x GN 1/1 or 10x 600x400	70	25	20	230	1490	610x410x(H)760	750x740x(H)1290	90

SHELF FOR BLAST CHILLERS

code
943564

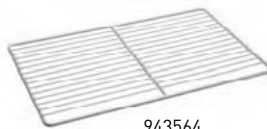

943564





233689



COUNTERTOP FREEZER DISPLAY 77L

- Intended for presentation and serving up to 4 hours. Not intended for long term storage of frozen produce.
- Body made of high-quality stainless steel, fitted with triple glazed cover with easy opening system.
- Forced air cooling with auto-defrost, compressor placed next to the chamber.
- Fits 8x GN 1/6 GN containers or 4x GN 1/3 containers (max. height 100 mm), not included.
- With 4 adjustable stainless steel feet.
- Digital temperature controller and display.
- Refrigerant: R290.
- Climate class: 4.
- Energielabel: E (A-G).

code	range	V	W	mm
233689	-24/-20°C	230	220	805x666x(H)305



233672



Watch the video



COUNTERTOP SALAD DISPLAY

- Body made of high-quality stainless steel, fitted with curved glass cover with easy opening system.
- Forced air cooling with auto-defrost, compressor placed next to the chamber.
- Fits 8x GN 1/6 GN containers or 4x GN 1/3 containers (max. height 100 mm), not included.
- With 4 adjustable stainless steel feet.
- Digital temperature controller and display.
- Refrigerant: R600a.
- Climate class: 4.
- Energy label: C (A-G).

code	range	V	W	mm
233672	0/3°C	230	105	767x612x(H)328





233757

SUSHI DISPLAY 5X GN 1/3

- White coated stainless steel housing, fitted with double glazing and curved glass cover.
- Accessible through two sliding doors at the back or via the curved glass cover.
- Forced air cooling with auto-defrost, compressor placed next to the chamber.
- Fits 5x GN 1/3 - (H) max. 40 mm trays.
- Fitted with LED lighting and evaporator at the top.
- Digital temperature controller and display.
- Refrigerant: R600a.
- Climate class: 3

code	range	V	W	mm
233757	3/7°C	230	160	1307x450x(H)330



CAKE DISPLAYS



Counter top model



233702



233719



COUNTERTOP DISPLAY FRIDGE

- Housing made of stainless steel fitted with curved glass front cover and glass side panels.
- Accessible through two sliding glass doors at the back.
- Forced air cooling with auto-defrost, compressor placed underneath the chamber.
- 2 chrome plated shelves included.
- Bright LED lighting in the ceiling.
- Digital temperature controller and display.
- Temperature range: 2 to 6°C.
- Climate class: 4
- Refrigerant: R600a.
- Energy label: B (A-G).



Watch the video

Forced air cooling



Digital display

code	liters	V	W	mm
233702	120	230	160	686x568x(H)686
233719	160	230	160	850x568x(H)686



REFRIGERATED DISPLAY CABINETS

- Display cabinet frame made of ABS+PVC polymers, with double glass.
- Unit housing made of ABS.
- Forced cooling with automatic defrosting, compressor placed under the chamber.
- Air duct outside of the glass blows air over the glass to remove and prevent condensation.
- Durable PVC coated shelves, adjustable in height.
- With bright LED lighting in the ceiling.
- Digital temperature controller and display.
- Climate class: 4



Watch the video



233610



233627



233634



REFRIGERATED DISPLAY CABINET, 58 L

- With 2 shelves.
- Fitted with an energy efficient inverter compressor, adjusts the power to the needs instead of only turning on or off.
- Energy label: C [A-G].
- Temperature range: 2 to 6°C.
- Refrigerant: R600a.

REFRIGERATED DISPLAY CABINET, 68 L

- With 3 shelves.
- Fitted with an energy efficient inverter compressor, adjusts the power to the needs instead of only turning on or off.
- Energy label: C [A-G].
- Temperature range: 2 to 6°C.
- Refrigerant: R600a.

code	-	V	W	mm
233610	white	230	170	452x406x(H)816
233627	black	230	170	452x406x(H)816

code	-	V	W	mm
233634	white	230	170	452x406x(H)891
233238	black	230	170	452x406x(H)891



Air duct outside glass to remove and prevent condensation



Double glazing and easy opening door



Digital controller





233641



233269



233696



REFRIGERATED DISPLAY CABINET, 78 L

- With 3 shelves.
- Fitted with an energy efficient inverter compressor, adjusts the power to the needs instead of only turning on or off.
- Energy label: C (A-G).
- Temperature range: 2 to 6°C.
- Refrigerant: R600a.

code	-	V	W	mm
233641	white	230	170	452x406x(H)966
233658	black	230	170	452x406x(H)966

REFRIGERATED DISPLAY CABINET, 98 L

- With 4 shelves.
- Fitted with an energy efficient inverter compressor, adjusts the power to the needs instead of only turning on or off.
- Energy label: C (A-G).
- Temperature range: 2 to 6°C.
- Refrigerant: R600a.

code	-	V	W	mm
233665	white	230	210	452x406x(H)1116
233269	black	230	210	452x406x(H)1116

REFRIGERATED DISPLAY CABINET, 270 L

- 5 shelves, dimensions 428x386x(h)18mm.
- Fitted with 4 wheels, 2 with brakes.
- Energy label: C (A-G).
- Temperature range: 2 to 8°C.
- Refrigerant: R290.

code	-	V	W	mm
233696	white	230	290	556x526x(H)1913
233290	black	230	290	556x526x(H)1913



Internal lighting in the ceiling



233696, 233290 - 4 wheels, 2 with brakes



233696, 233290 - Double glazing and easy opening curved door



233825



233832



233276

COOLING



ROUND CAKE DISPLAY, ARKTIC

- Housing made of stainless steel fitted with tempered double glazing.
- Accessible through self-closing door.
- Forced air cooling with auto-defrost, compressor placed underneath the chamber.
- Fitted with 3 adjustable glass shelves.
- Bright LED lighting on 2 sides.
- Digital temperature controller and display, with on/off switch.
- Temperature range: 0/6°C.
- Climate class: 6
- Refrigerant: R600a.
- Energy label: B.

ROUND CAKE DISPLAY, ARKTIC

- Housing made of stainless steel fitted with tempered double glazing.
- Accessible through self-closing door.
- Forced air cooling with auto-defrost, compressor placed underneath the chamber.
- Fitted with 4 adjustable glass shelves.
- Bright LED lighting on 2 sides.
- Fitted with 5 castors of which 2 has a brake.
- Digital temperature controller and display, with on/off switch.
- Temperature range: 0/6°C.
- Climate class: 4 Refrigerant: R290.
- Average daily electricity consumption: 7,23 kWh.
- Energy label: B.

REFRIGERATED DISPLAY CABINETS, ARKTIC

- Housing made of stainless steel fitted with triple glazing.
- Fitted with an energy efficient inverter compressor, adjusts the power to the needs instead of only turning on or off.
- Forced air cooling with auto-defrost, compressor placed underneath the chamber.
- Fitted with 3 adjustable chrome plated shelves.
- Bright LED lighting in the 4 posts.
- Fitted with 4 castors of which 2 have brakes.
- Digital temperature controller and display, with on/off switch.
- Temperature range: 0/6°C.
- Climate class: 4.
- Refrigerant: R290.
- Energy label: B.

code	liters	V	W	mm
233825	100	230	210	ø480x(H)1030

code	liters	V	W	mm
233832	360	230	460	ø680x(H)1750

code	liters	V	W	mm
233276	400	230	495	650x650x(H)1908



233306



233443
233320



233337



233450
233375
233467



233306



233337

REFRIGERATED DISPLAY CABINETS WITH 3 SLANTED SHELVES ARKTIC

- Fitted with 3 adjustable slightly slanted glass shelves.
- Energy label: C (233306), B (233443, 233320).
- Temperature range: 0°/6°C.

code	liters	V	W	mm
233306	300	230	480	650x805x(H)1445
233443	500	230	490	900x805x(H)1445
233320	650	230	490	1200x805x(H)1445

REFRIGERATED DISPLAY CABINETS WITH 2 SHELVES

- Fitted with 2 adjustable glass shelves.
- Energy label: C (233337), B (233450, 233375, 233467).
- Temperature range: 0°/6°C.

code	liters	V	W	mm
233337	300	230	480	915x675x(H)1210
233450	410	230	490	1215x675x(H)1210
233375	510	230	490	1515x675x(H)1210
233467	610	230	500	1815x675x(H)1210



LED lights



Electronic temperature controller



4 spinning wheels

BACK BAR REFRIGERATORS



- Powder coated housing, embossed aluminium chamber, plastic lockable door(s) with toughened glass.
- Forced air cooling with auto-defrost, compressor placed underneath the chamber.

- Chamber fitted with LED lighting.
- Digital display and temperature control.
- Fitted with 4 adjustable non-slip feet.
- Refrigerant: R600a.



	1-door	2-door	Double sliding door
code	233900	235829	233917
capacity	93 L	180 L	197 L
dimensions	500x500x(H)900 mm	900x500x(H)900 mm	900x500x(H)900 mm
shelves	2 chrome plated	4 chrome plated	4 chrome plated
range	2/10°C	2/10°C	2/10°C
coolant	R600a	R600a	R600a
energy class	D	D	E
power/voltage	130 W/230 V	160 W/230 V	220 W/230 V



	Triple sliding door	1-door	2-door
code	235836	233924	233931
capacity	303 L	287 L	448 L
dimensions	1335x500x(H)900 mm	600x515x(H)1820 mm	900x515x(H)1820 mm
shelves	6 chrome plated	5 chrome plated	10 chrome plated
range	2/10°C	2/10°C	2/10°C
coolant	R600a	R600a	R600a
energy class	E	E	E
power/voltage	215 W/230 V	240 W/230 V	300 W/230 V



DISPLAY REFRIGERATORS WITH LIGHTBOX

- Made of stainless steel, aluminium and polypropylene.
- Doors fitted with triple glazing of which one layer is tempered.
- Forced air cooling with auto-defrost, compressor placed underneath the chamber.



- With LED lighting in the chamber and in the lightbox.
- Fitted with 4 castors of which 2 have brakes.
- Digital temperature controller and display.
- Climate class: N-ST.



E A ↑ G

233788



F A ↑ G

233795

	1-door	2-door
code	233788	233795
capacity	313 L	618 L
dimensions	620x669x(H)1965 mm	1120x595x(H)1965 mm
shelves	4 adjustable PVC coated shelves	8 adjustable PVC coated shelves
shelf dimensions	498x442x(H)26 mm	442x498x(H)26 mm
range	2/10°C	2/10°C
coolant	R600a	R290
energy class	E	F
power/voltage	300 W/230 V	400 W/230 V

LED lighting in the lightbox.



LED lighting in the chamber.



Adjustable PVC coated shelves

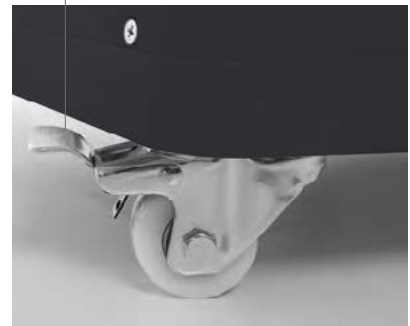

Fitted with 4 castors of which 2 have brakes.



COOLING



WINE COOLERS, DUAL ZONE

- Two cooling zones with the possibility to set different temperatures in each of them.
- Black powder-coated housing, frameless tempered glass door with stylish stainless steel handle.
- Static cooling supported with a fan, automatic defrosting, chiller located at the back of the cooler.
- LED light at the top of the chamber.

Arktic
REFRIGERATION SINCE 1932

S.S.
stainless steel

- Digital display and electronic thermostat.
- Temperature displayed in degrees Celsius, possibility to switch to Fahrenheit.
- 4 adjustable non-slip feet.
- Climatic class: N-ST.
- Refrigerant: R600a.



THE IDEAL TEMPERATURE OF SPECIFIC WINES (FROM REDS TO WHITES):

Temperature	Types of wine
18°C	Bordeaux, Cabernet Sauvignon, Shiraz
16°C	Rioja, Pinot Noir
15°C	Chianti, Zinfandel
14°C	Chinon, Porto, Madeira
10°C	Chardonnay, Sauternes
9°C	Sauvignon Blanc
6°C	Champagne Non Vintage, Prosecco, Cava, Asti



code	237588	237557	237564	237595
capacity	133 L max 46 bottles of wine	232 L max 72 bottles of wine	387 L max 135 bottles of wine	447 L max 160 bottles of wine
dimensions	595x588x(H)820 mm	595x605x(H)1225 mm	595x680x(H)1625 mm	595x685x(H)1795 mm
shelves	5 wooden	9 wooden	13 wooden	15 wooden
range	5/22°C	5/22°C	5/22°C	5/22°C
coolant	R600a	R600a	R600a	R600a
energy class	G	G	G	G
climatic class	N-ST	N-ST	N-ST	N-ST
power/voltage	90 W/230 V	110 W/230 V	130 W/230 V	150 W/230 V



233412



COUNTERTOP DISPLAY FREEZER 90L

- Inner housing made of High Impact Polystyrene (HIPS) and Polypropylene.
- Outer housing made of painted steel.
- Lockable door is fitted with triple glazing and heating element to prevent fogging up.
- Forced air cooling, compressor placed underneath the chamber.
- Fitted with 3 adjustable PVC coated shelves.
- With LED lighting at the top of the freezer.
- Digital temperature controller and display, with defrost button.
- Climate class: 4.
- Refrigerant: R290.
- Adjustable feet.
- Energy label: D (A-G).

PP
polypropylene

code	range	V	W	mm
233412	-18/-14°C	230	230	620x575x(H)712

DISPLAY TRAYS ALUMINIUM



CONFECTIONERY DISPLAY TRAY



code	mm
808504	400x300x(H)20
808511	600x400x(H)20



CONFECTIONERY DISPLAY TRAY



code	mm
808566	400x300x(H)20
808573	600x400x(H)20

DISPLAY TRAYS MELAMINE



568200



MEAT TRAY

- Black melamine.

code	mm
568101	290x160x(H)35
568200	350x250x(H)40
568309	420x280x(H)60



568507



MEAT TRAY

- Black melamine.

code	mm
568408	290x160x(H)60
568507	300x190x(H)80



568804



MEAT TRAY

- Black melamine.

code	mm
568804	280x210x(H)60



569108



DISPLAY TRAY

- Black melamine.

code	mm
569009	270x210x(H)17
569016	300x150x(H)17
569108	300x190x(H)17
569207	350x240x(H)17



DISPLAY TRAYS STAINLESS STEEL



407202

DISPLAY TRAY

- With feet.



code	mm
407202	240x170



407400

DISPLAY TRAY

- Not suitable for high temperatures



code	mm
407400	345x245



408308

DISPLAY TRAY



code	mm
408308	310x230



508206

MEAT TRAY



code	mm
508107	260x200x(H)48
508206	310x240x(H)48



429419

BREADROLL DISPENSER

- For 7 rolls.



code	mm
429419	475x105x(H)60



429457

TACO HOLDER



code		mm
429440	2 slots	135x115x(H)50
429457	4 slots	225x115x(H)50





15x GN 1/1

15x 600x400



7x GN 1/1

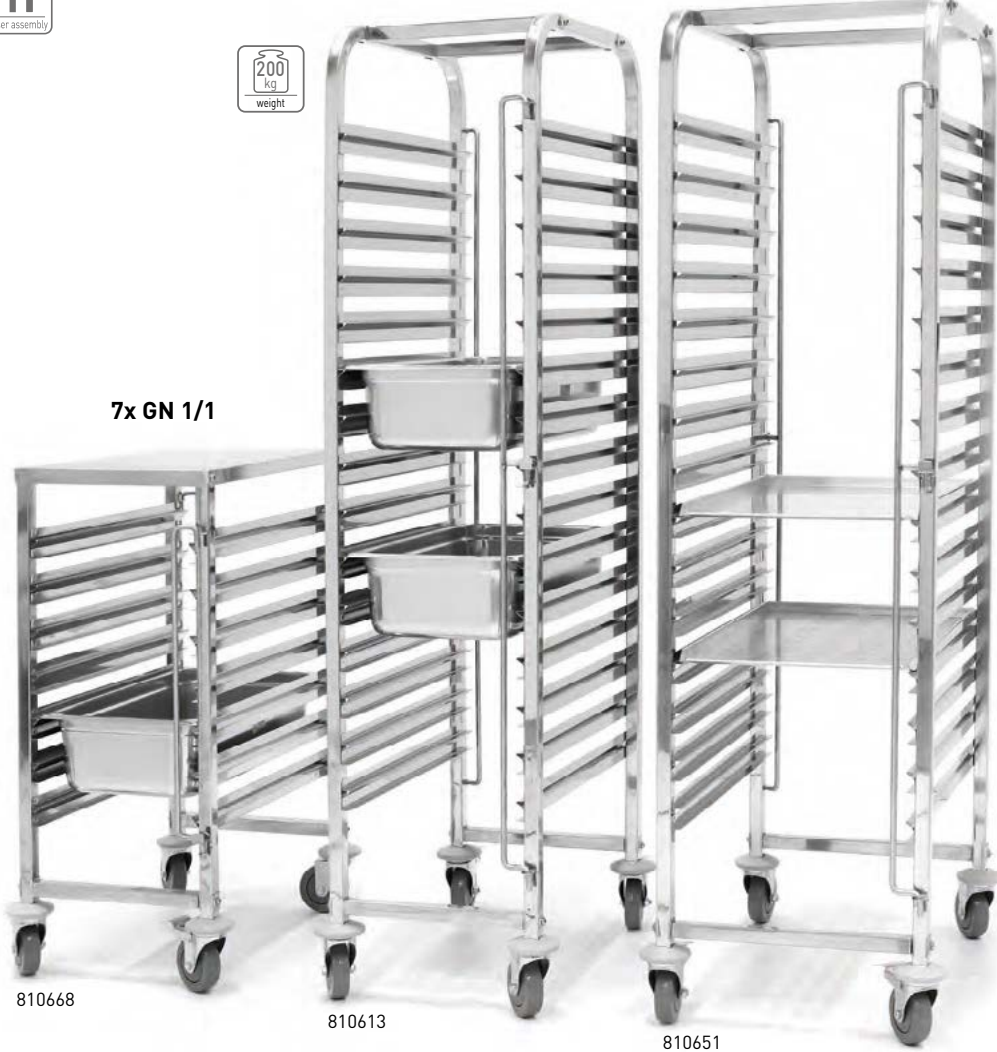

810668

810613

810651

THERMOBOXES, RACKS, TROLLEYS



CLEARING TROLLEY - 7 X GN 1/1

- Designed to fit GN 1/1 Trays/containers - interspaced at 80 mm.
- With working surface.
- Tray locks on either side.
- Fitted with four castors of which two have brakes.
- GN 1/1 - 530x325.
- Permissible load of the trolley 150 kg with an evenly distributed weight.
- Flatpack delivery.

CLEARING TROLLEY - 15 X GN 1/1

- GN 1/1 with 15 layers - interspaced at 80 mm.
- Tray locks on either side.
- Fitted with four castors of which two have brakes.
- Permissible load of the trolley 150 kg with an evenly distributed weight.
- Flatpack delivery.

CLEARING TROLLEY - 15X 600X400

- 600x400 mm 15 layers - interspaced at 80 mm.
- Tray locks on either side.
- Fitted with four castors of which two have brakes.
- Permissible load of the trolley 150 kg with an evenly distributed weight.
- Flatpack delivery.

code	mm
810668	445x615x(H)945

code	mm
810613	440x610x(H)1710

code	mm
810651	515x680x(H)1710



Two castors have brakes



Equipped with a simple locking system





30x GN 1/1



810576

DOUBLE TROLLEY - 30 X GN 1/1

- GN 1/1 with 30 layers - interspaced at 80 mm.
- Tray locks on either side.
- Fitted with four castors of which two have brakes.
- Flatpack delivery.
- Permissible cart load capacity with uniform weight distribution - 150 kg.

code	mm
810576	740x550x(H)1730

15x GN 1/1

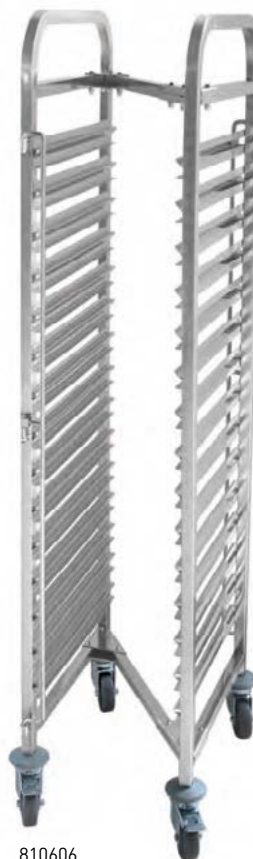

810606



In order to save space during storage trolleys can be pushed into one another

CLEARING TROLLEY COMPACT STORAGE - 15 X GN 1/1

- In order to save space during storage trolleys can be pushed into one another.
- GN 1/1 with 15 layers - interspaced at 80 mm.
- Tray locks on either side.
- Fitted with four castors of which two have brakes.
- Flatpack delivery.
- Permissible cart load capacity with uniform weight distribution - 150 kg.

code	mm
810606	445x610x(H)1710

12x GN 1/1



810569



DOUBLE MOBILE TROLLEY - 12 X GN 1/1

- GN 1/1 with 12 layers - interspaced at 80 mm.
- Tray locks on either side.
- Fitted with four castors of which two have brakes.
- Permissible load of the trolley 150 kg with an evenly distributed weight.
- Flatpack delivery.

code	mm
810569	740x550x(H)940



810002

810101

SERVING TROLLEY

- Made of stainless steel.
- Fitted with 2 shelves and sound insulation material underneath.
- Maximum load per shelf 50 kg.
- Includes 4 castors, of which 2 with brakes, fitted with corner protection.
- Distance between shelves 550 mm.
- Worktop 830x510 mm.
- Flatpack delivery.

code	mm
810002	905x585x(H)945

SERVING TROLLEY

- Made of stainless steel.
- 3 shelves with noise reducing material underneath.
- Maximum load per shelf 50 kg.
- Includes 4 castors, of which 2 with brakes, fitted with corner protection.
- Distance between shelves 270 mm.
- Worktop 830x510 mm.
- Flatpack delivery.

code	mm
810101	905x585x(H)945



811320

SERVING TROLLEY MATT BLACK

- Made of stainless steel with a matt black finish.
- 3 shelves with noise reducing material underneath.
- Maximum load per shelf 50 kg.
- Includes 4 castors, of which 2 with brakes, fitted with corner protection.
- Distance between shelves 270 mm.
- Worktop 830x510 mm.
- Flatpack delivery.

code	mm
811320	905x585x(H)945



810224

SERVING TROLLEY HEAVY DUTY

- Made of stainless steel, welded for extra strength.
- Fitted with 3 shelves.
- Maximum load per shelf 80 kg.
- Fitted 4 castors, of which 2 with brakes.

code	mm
810224	800x500x(H)850



810118

SERVING TROLLEY WITH 4 SHELVES

- Made of stainless steel.
- Fitted with 4 shelves.
- Includes 4 castors, of which 2 with brakes, fitted with corner protection.
- Flatpack delivery.

code	mm
810118	905x585x(H)1245



810125

SERVING TROLLEY WITH 5 SHELVES

- Made of stainless steel.
- Fitted with 5 shelves.
- Includes 4 castors, of which 2 with brakes, fitted with corner protection.
- Flatpack delivery.

code	mm
810125	905x585x(H)1545



810200



3-SHELF POLYPROPYLENE SERVICE CART

- Can be used as a mobile tool, suitable for storing.
- Moves smoothly over uneven surfaces, in elevators or walkways.
- Top shelf placed at an ergonomic height for greater comfort.
- Shelf spacing: 340 mm.
- Maximum load per shelf (provided that the load is distributed evenly): 50 kg.
- Fitted with 4 swivel castors with corner protection, 2 with brakes.
- Rounded corners.

code	mm
810200	800x410x(H)950



Collapsible to minimize transport dimensions



PLATFORM TROLLEY

- Despite its low weight it can carry up to 150 kg.
- Collapsible to minimize transport dimensions.
- With two castor wheels.

code	mm
810514	730x480x(H)825



PLATE TROLLEY

- Assures safe transport of tableware.
- Mobile polyethylene guards make it possible to load plates of various sizes.
- Extremely robust design made of polyethylene protects the tableware from chipping or breaking.
- Number of plates stacks: 6.
- Number of plates per stack: 50.
- Wheels resistant to uneven ground, non-marking even at full load.
- Two castor wheels with brakes \varnothing 10 mm, large wheels \varnothing 20 mm.
- Shock and impact resistant.
- Vinyl cover to meet strict sanitary standards included.
- Plates diameter from \varnothing 170 to \varnothing 330 mm.



877906



includes vinyl cover with every caddy for sanitary storage



up to 50 plates in one stack



front wheels with brakes

\varnothing 115

**Examples of sets**

4x \varnothing 230-335 mm



6x \varnothing 118-230 mm



4x \varnothing 115 mm
2x \varnothing 140 mm
2x \varnothing 230 mm



5x \varnothing 128 mm
2x \varnothing 231 mm



5x \varnothing 102 mm
2x \varnothing 334 mm



871102

CUTLERY BASKET

- 8 sections with handle.



code	mm
871102	425x205x(H)150



552001

TOTE BOX

- Grey, with handles.



code	mm
552001	555x410x(H)130



871300

CUTLERY BASKET

code	mm
871300	110x110x(H)140



871324

CUTLERY BASKET

code	mm
871324	125x84x(H)135

MAX.

110 l



INSULATED ICE CONTAINER - 110 L

- Ideal to transport ice cubes or flakes over long distances.
- Robust polyethylene housing resistant to shocks and impact.
- Thick foam insulation to keep ice temperature as long as possible.
- Inner walls resistant to scratches and stains.
- Sliding, sealed lid allowing easy scooping of ice.
- Ergonomic grip integrated with housing.
- Two large wheels resistant to uneven ground and two smaller castor wheels with brake.
- Profiled drain for melted ice in chamber, with tap.
- Delivered ready-to-use, does not require assembly.
- 4 wheels, 2 with brakes (large Ø 20 mm, small Ø 10 mm).
- Tap, scoop and drip tray included.

code	liters	mm
877883	110	585x800x(H)745



877883



drip tray



2 torsion wheels with brakes



tap



scoop

MAX.

98 l



INGREDIENT TROLLEY

- Useful in any large kitchen to store, transport and quick measure of quantities of dry food such as: flour, sugar, salt, groats, rice.
- One-piece, solid and sturdy polyethylene structure.
- Rounded corners and smooth inner walls are ideal for easy cleaning.
- Guides located in the upper, inner part of the trolley permit the comfortable fitting of the scoop.
- Transparent polycarbonate lid for easy identification or product type and quantity.
- Four wide, rubber wheels Ø 75 mm, including two castor wheels with brakes for easier transport.
- Ergonomic height of 71 cm ideal to put under a worktable.

code	liters	mm
877913	81	333x743x(H)711
877920	98	394x755x(H)735



877920



scoop



transparent cover



four torsional wheels



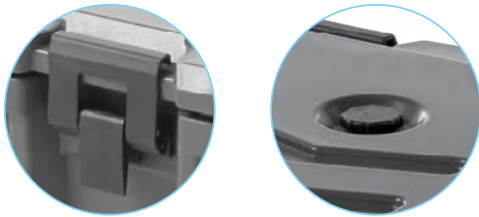

INSULATED CATERING CONTAINER GN 1/1, TOP-LOADED

- Made of HDPE polyethylene.
- Double walls filled with high quality polyurethane foam assure perfect insulation and long holding of food temperature.
- Tight lid with 4 clamps made of tough nylon.

code	mm int.	mm
877852	530x325x(H)200	630x460x(H)305

Temperature retention

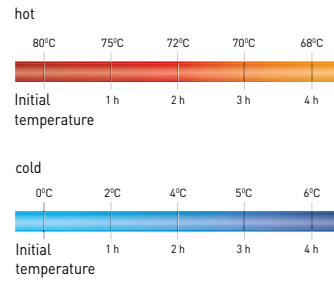

stackable

Examples of sets

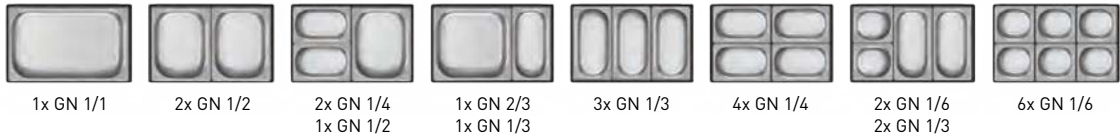

INSULATED BEVERAGE DISPENSER WITH TAP

- Ideal for storage, transport and serving of hot and cold drinks.
- Robust LDPE polyethylene housing.
- Good polyurethane foam insulation.
- 4 heavy duty clamps, 25 mm wide, at either side of the jug, for easy and quick opening and closing.
- Comfortable transport grips.

- Tap distance from the floor: 95 mm.
- Recessed tap - protection against transport damage.
- Delivered with stickers for quick identification of drinks.
- Vent for easier lid opening.
- Shock and impact resistant.
- Rounded chamber with grooves leading to the tap.



877869

place for sticker

Temperature retention

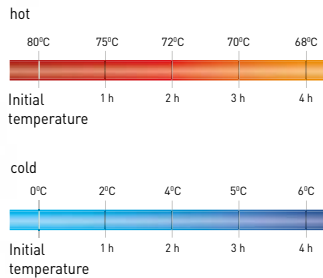

4 heavy duty clamps



877876

code	liters	mm
877869	9.4	230x420x(H)470
877876	18	230x420x(H)620

877814



877821

front wheels with brakes

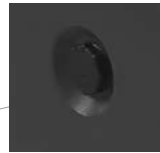

Temperature retention

hot

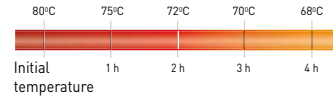

cold

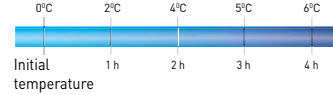

Examples of sets

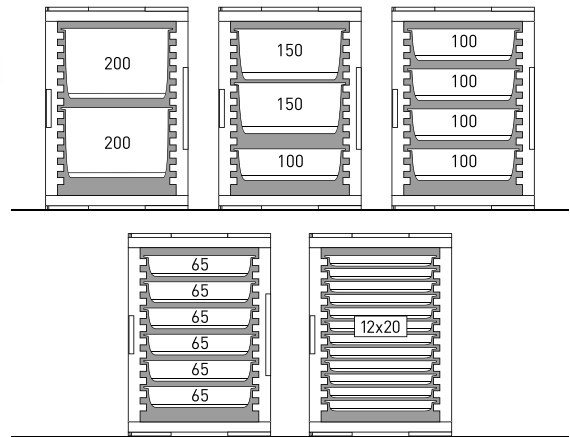

THERMO CATERING CONTAINER 2X GN 1/1 200

- Double-walled insulated polyethylene LDPE - impact resistant hard polyethylene.
- Keeps hot and cold.
- With 2 sturdy carrying handles.
- Press-formed guides fitted in chamber housing.
- Inside dimensions: 335x533x(H)590 mm.
- Suitable for 1/1 Gastronorm trays:
 - 12 GN trays - 10 mm deep.
 - 6 GN trays - 65 mm deep.
 - 4 GN trays - 100 mm deep.
 - 3 GN trays - 150 mm deep.
 - 2 GN trays - 200 mm deep.

code	mm int.	mm
877814	335x533x(H)590	477x680x(H)620

TROLLEY FOR THERMO CONTAINER

code	mm
877821	530x710x(H)230



THERMO FRONT LOADERS



5x GN 1/1



707661

THERMO CATERING BOX

- Ultra-lightweight, durable container with perfectly sealable opening.
- Removable door – even if the boxes are stacked
- With 5 grooves spaced 65 mm apart to slide in containers, fits GN 1/1 containers.
- The high stacking ledges with locking profile ensures stable stacking without sliding.
- Fits perfectly on Euro pallets – four boxes per layer

code	liters	mm int.	mm
707661	66	535x310x(H)400	600x400x(H)490

Examples of sets



707784

707845



HEATING ELEMENT

- Can be heated up to 90°C.
- To heat the element, place it on a stainless steel tray or in a container and place in a convection oven, max 90°C for max. 40 minutes.

code	GN	mm
707784	GN 1/2	320x265x(H)30
707845	GN 1/1	530x325x(H)30

707760

707753



FREEZING ELEMENT

- For use in thermoboxes, keeps the temperature between -12 to -10°C for 3 to 4 hours thanks to the eutectic plate.
- Before use: freeze at -18°C for 24 hours or until frozen solid.
- To check if ready, shake the element and when you feel and hear nothing moving inside it's ready.

code	GN	mm
707753	GN 1/1	530x325x(H)30
707760	GN 1/2	320x265x(H)30





THERMO CATERING BOX

- Ultra-lightweight, durable container with perfectly sealable opening.
- Suitable for Gastronorm 1/1 containers.
- With 8 grooves spaced 61 mm apart to slide in GN containers.
- The high stacking ledges with locking profile ensures stable stacking without sliding.

code	liters	mm int.	mm
707999	100	550x335x(H)545	635x465x(H)660



707999



Examples of sets

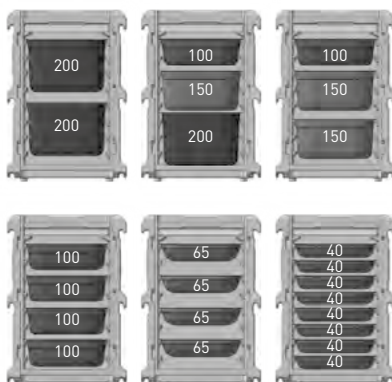

70777

707821



COOLING ELEMENT

- For use in thermoboxes, keeps the temperature between 0 to 4°C for 3 to 4 hours thanks to the eutectic plate.
- Before use: freeze at -18°C for 24 hours or until frozen solid.
- To check if ready, shake the element and when you feel and hear nothing moving inside it's ready.

code	GN	mm
707777	GN 1/2	320x265x(H)30
707821	GN 1/1	530x325x(H)30



209509



HOT TRAY

- GN 1/1 - aluminium.
- On insulated base.
- Automatically heats itself to 95°C.
- Can be used in combination with Thermobox Kitchen Line GN 1/1 and bigger (707906, 707968, 707951, 707944)

code	V	W	mm
209509	230	190	530x325x(H)30





707975

PIZZA THERMOBOX PROFI LINE

- Made of polypropylene.
- Integrated grips for easier carrying.
- Special profile in the inside for easier unloading.
- Sturdy and stable structure designed for long-term use.
- Ultralight, closed from the top with a separate lid.
- Stackable thanks to grooves in housing.

code	liters	mm int.	mm
707975	21	350x350x(H)175	410x410x(H)240

With ergonomic handles to transport

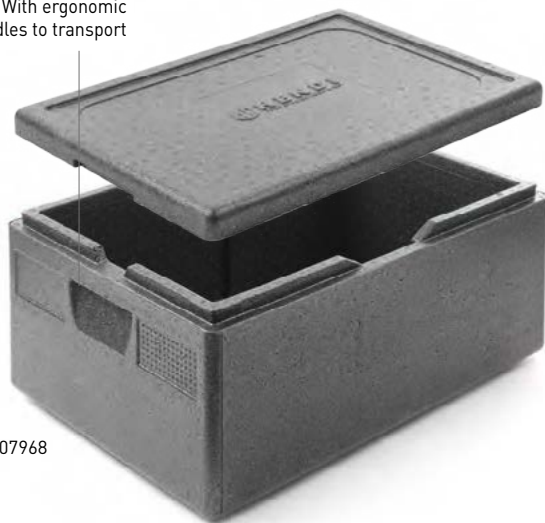

707968

THERMOBOX PROFI LINE

- Perfect for transport of hot or cold products.
- Containers offer high insulation levels.
- Withstands temperatures ranging from -20°C to +110°C.
- With recessed handles at the side.

code	liters	mm int.	mm
707906	40	538x338x(H)234	600x400x(H)285
707968	46	538x338x(H)257	600x400x(H)320
707951	53	625x425x(H)200	685x485x(H)260
707944	80	625x425x(H)300	685x485x(H)360



707814

COOLING ADAPTOR EPP GN 1/1

- Place this adaptor with cooling element on top of your Thermobox Kitchen Line GN 1/1 and keep the goods cold for extra long periods of time.
- Supplied without cooling element.
- Fits on top of 707906 and 707968.

code	mm
707814	600x400x(H)85



707982

Extremely smooth internal surface

THERMOBOX PROFI LINE

- Perfect for transport of hot or cold products.
- The special heat-sealed inner lining provides reinforcement, facilitates easy cleaning and substantially improves the useful life.
- The thermobox is suitable for containers sizes up to Gastronorm 1/1.
- Boxes have a sealed structure which provides exceptional insulation, up to 50% better than other HENDI thermoboxes.
- Temperature resistant from -20°C up to 110°C.
- Practical integrated handles allow for comfortable carrying.
- The thermoboxes are stackable both with and without lids.

code	liters	mm int.	mm
707982	39	538x338x(H)217	674x400x(H)287





The same diameters make them easier to stack and transport

6 latches – ideal for transporting liquid meals



710203

Ergonomic handles



Flexible material protects the container and the floor against damage



Air valve



Double lid secured with a seal and equipped with 6 latches



INSULATED PORTABLE CONTAINER

- Designed for catering establishments to keep food and drinks warm during transport.
- The space between the walls is filled with a special insulating material, which ensures that the temperature is maintained for 6 to 8 hours.
- Housing and lid made of AISI 430 steel, satin finish, thickness: 0.8 mm.
- The interior and lid of the container made of AISI 304 steel, thickness: 0.8 mm.
- Container interior made of high gloss polished steel, satin finished lid interior.
- Two ergonomic handles, each fixed with nine seals for safe handling.
- Insulated lid with handle and large vent valve for easy opening.
- Thick silicone seal, removable – hygienic.
- Lid with 6 snap fasteners.
- Container bottom equipped with a black rubber ring fixed with screws, which ensures easier stacking of containers and protects the container as well as the ground against damage.
- Stackable – different models up to 35 l.

Space between the walls is filled with special insulating material which keeps hot or cold temperature of food for up to 6-8 hours



code	liters	mm
710104	10	ø330x(H)220
710203	20	ø330x(H)360
710302	35	ø330x(H)570





812266



812273

ALUMINIUM STORAGE RACK FOR GN CONTAINERS

- GN 1/1 containers fit directly between the aluminum supports.
- Anodized aluminium frame.
- With dishwasher safe polypropylene shelves.
- Easily expandable.
- Carrying capacity 150 kg, distributed across the surface.

code	-	mm
812266		1120x355x(H)1685
812372	connecting hook	15x42x(H)42

ALUMINIUM STORAGE RACK

- Frame made of corrosion resistant anodized aluminium.
- With 4 shelves, each shelf consists of 3 removable polypropylene elements which are dishwasher safe.
- Adjustable feet to ensure level placement.
- Connect racks to each other or create corner racks with the connecting hook available in the assortment (code: 812280).
- Max. spread load capacity per shelf: 150 kg.

code	-	mm
812273		1280x405x(H)1685
812280	connecting hook	15x42x(H)42
812341	shelf	

NEW



812280



812341

Easily expandable

GN 1/1 containers fit directly between the aluminum supports

Plastic shelves can be cleaned in a dishwasher



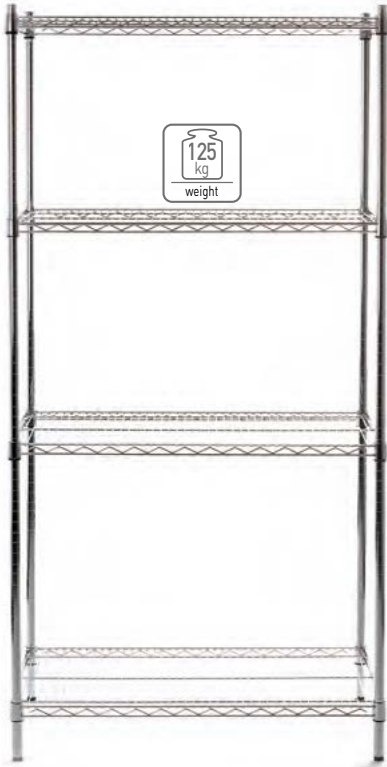
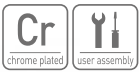

812259

HEAVY-DUTY STORAGE RACK

- 4 adjustable shelves.
- Maximum load per shelf 125 kg.
- Fitted with adjustable feet.
- Chrome-plated iron.

code	mm
812259	910x455x(H)1830

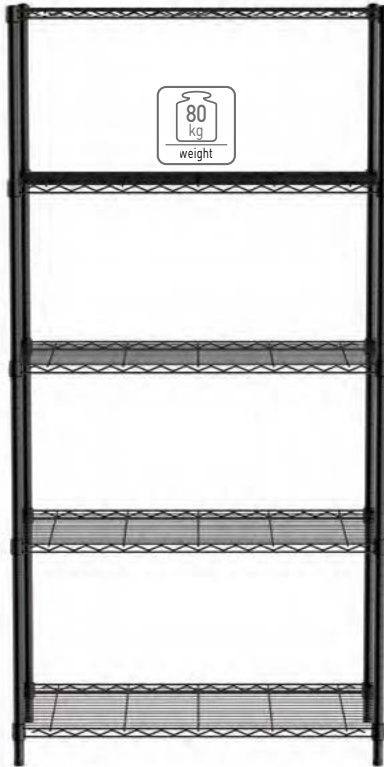

812990

STORAGE RACK WITH 5 SHELVES

- Made from steel, available in a chrome plated finish or black powder coated finish.
- Easy to assemble, shelf height is easily set.
- Supplied with 5 wire shelves.
- Spread load capacity per shelf: 80 kg.
- Fitted with adjustable feet.

code	colour	mm
812990	Black	910x455x(H)1830
812204	Chrome	910x455x(H)1830



812204



Stainless steel furniture for self-assembly.
 Fast and easy fastening.
 Compact packaging - low shipping costs.



ADJUSTMENT HEX KEY FOR QUICK ASSEMBLY



SOLID FASTENING OF LEGS USING TWO SCREWS



STABLE LEVELLING AND HEIGHT ADJUSTMENT





STORAGE RACKS WITH 4 SHELVES

- Made of AISI 430 stainless steel
- Feet made of 30x30 mm profiles
- Approximate maximum load per shelf - 70 kg/m²
- Adjustable feet - 25 mm upwards or 5 mm downwards

code	mm
812556	1000x600x(H)1800
812501	600x400x(H)1800
812518	800x400x(H)1800
812525	1000x400x(H)1800
812532	1000x500x(H)1800
812549	1200x500x(H)1800
812563	1200x600x(H)1800



812525



816486

WALL SHELF, WITH TWO STEEL BRACKETS

- Made of AISI 430 stainless steel.
- Welded for high durability and stability.
- Approximate maximum load per shelf - 25 kg/m².
- 30 mm backsplash prevents the goods from falling down.
- Delivered with 2 steel brackets for wall-mounting.

code	mm
816486	800x300x(H)250
816493	1000x300x(H)250
816509	1200x300x(H)250
816516	1400x300x(H)250



DOUBLE ADJUSTABLE WALL SHELF, WITH TWO STEEL BRACKETS

- Made of AISI 430 stainless steel.
- The backsplash prevents the goods from falling down.
- Removable shelf with smooth surface for easy cleaning.
- Maximum load per shelf (provided that the load is distributed evenly): 25 kg.
- Welded for high durability and stability.
- Delivered with 2 steel brackets for wall-mounting.

code	mm
DEPTH 300 MM	
811771	800x300x(H)600
811726	1000x300x(H)600
811733	1200x300x(H)600
811740	1400x300x(H)600
DEPTH 400 MM	
816592	1000x400x(H)600



WORK TABLES SELF-ASSEMBLY



- Made of AISI 430 stainless steel.
- Screwed.
- Legs made of 40x40 mm profiles.
- Worktop filled from below with waterproof laminated board that reinforces the item and forms a soundproofing layer.

- With a 40 mm backslash – to maintain hygiene.
- Rear legs moved from the wall by 150 mm to ensure easy wall-mounting.
- Adjustable feet – 25 mm upwards or 5 mm downwards.



811511



811467

WORK TABLE HEAVY DUTY

- Shelf mounted at 160 mm from the floor, leaving plenty of space for larger appliances and boxes.
- Approximate maximum load per worktop and per shelf – 70 kg/m².

code	mm
WITH SHELF, DEPTH 600 MM	
811511	1000x600x(H)850
811528	1200x600x(H)850
811535	1400x600x(H)850
811542	1600x600x(H)850
811559	1800x600x(H)850

code	mm
WITH SHELF, DEPTH 700 MM	
810705	1000x700x(H)850
810712	1200x700x(H)850
810729	1400x700x(H)850
810736	1600x700x(H)850
810743	1800x700x(H)850

WALL WORK TABLE WITH UPSTAND AND SHELF

- Shelf mounted at 160 mm from the floor, leaving plenty of space for larger appliances and boxes.
- Approximate maximum load per worktop and per shelf – 70 kg/m².

code	mm
DEPTH 600 MM	
811450	800x600x(H)850
811467	1000x600x(H)850
811474	1200x600x(H)850
811481	1400x600x(H)850
811498	1600x600x(H)850
811504	1800x600x(H)850

code	mm
DEPTH 700 MM	
812716	800x700x(H)850
812723	1000x700x(H)850
812730	1200x700x(H)850
812747	1400x700x(H)850
812754	1600x700x(H)850
812761	1800x700x(H)850

CENTRAL WORK TABLE

- Worktop and shelf made of stainless steel, shelf connected to the stainless steel legs with an aluminium collar.
- Height-adjustable legs.
- Robust construction.
- Tabletop and shelf both have a spread load capacity of 130 kg.

code	mm
812457	1200x600x(H)880
812440	1000x600x(H)880
812464	1400x600x(H)880
812471	1600x600x(H)880
812488	1800x600x(H)880



812440



SINK TABLES – SCREWED

- Sink bowls pressed from a single sheet of stainless steel characterised by high resistance to food acids and chemicals
- Sink bowl seamlessly welded into the worktop
- Sink dimensions: 400x400x(H)250 mm
- Drain compatible with standard traps: Ø50 mm
- Tap opening Ø30 mm
- Worktop with 10 mm recess to prevent water from flowing out



- Screwed
- Feet made of 40x40 mm profiles
- 40 mm backsplash prevents the walls from being stained
- Feet legs moved from the wall by 50 mm to ensure easy wall-mounting
- Adjustable feet – 25 mm upwards or 5 mm downwards



811870



811887

SINGLE SINK TABLE WITH SHELF - FOR SELF-ASSEMBLY

- Stainless steel shelf mounted at 200 mm, non-adjustable.
- Approximate maximum load per worktop and per shelf – 70 kg/m².

code	mm	sink location
DEPTH 600 MM		
811863	800x600x(H)850	on the right
812495	800x600x(H)850	on the left
DEPTH 700 MM		
812938	1000x700x(H)850	on the right
812945	1000x700x(H)850	on the left

DOUBLE SINK TABLE WITH SHELF - FOR SELF-ASSEMBLY

- Stainless steel shelf mounted at 200 mm, non-adjustable.
- Approximate maximum load per worktop and per shelf – 70 kg/m².

code	mm	sink location
DEPTH 600 MM		
811887	1000x600x(H)850	in the middle
DEPTH 700 MM		
812969	1000x700x(H)850	in the middle

Worktop with 10 mm recess to prevent water from flowing out



811818



SINK

- Made of durable stainless steel (AISI 304).
- Intended for wall-mounting.
- Internal dimensions 350x250x(H)100mm.
- ø35mm opening for tap instalment, fits HENDI 970522 tap.
- ø52mm drain compatible with standard traps

code	mm
811818	400x295x(H)145

BUDGET LINE TABLES – SCREWED



- Robust construction made entirely of AISI 430 stainless steel.
- Worktop reinforced from the bottom with a longitudinal profile.
- With a 40 mm upstand.
- Shelf mounted at 160 mm from the floor, leaving plenty of space for larger appliances and boxes.

- Both the worktop and shelf have a spread load capacity of 70 kg/m².
- The legs are adjustable in height to guarantee level installment (+25/-5 mm).
- Flat pack delivery for self-assembly.



817162



817278

CENTRAL WORK TABLE WITH A SHELF BUDGET LINE – SCREWED

code	mm
817094	600x600x(H)850
817100	800x600x(H)850
817162	1000x600x(H)850
817179	1200x600x(H)850

WALL WORK TABLE WITH SHELF BUDGET LINE – SCREWED

code	mm
817223	600x600x(H)850
817261	800x600x(H)850
817278	1000x600x(H)850
817285	1200x600x(H)850

DOUBLE SINK TABLE WITH SHELF BUDGET LINE – SCREWED

- Durable construction made entirely of AISI 430 stainless steel.
- 2 sink bowls (400x400x(H)250 mm), each pressed from a single sheet of stainless steel, seamlessly welded into the worktop.
- With a 40mm upstand. Shelf mounted at 160 mm from the floor, leaving plenty of space for larger appliances and boxes.
- Both the worktop and shelf have a spread load capacity of 70 kg/m².
- The legs are adjustable in height to guarantee level installment (+25/-5 mm).
- ø30mm opening for tap instalment, fits HENDI 970515 and 970508 taps.
- ø52mm drain compatible with standard traps.

code	mm
817032	1000x600x(H)850



817032



WALL WORK TABLE CABINETS – WELDED

430

stainless steel

- Made of AISI 430 stainless steel
- Welded for high durability and stability
- Worktop filled from below with waterproof laminated board that reinforces and soundproofs the item
- Approximate maximum load per worktop – 70 kg/m²
- 40 mm backsplash prevents the walls from being stained
- Door handles made of plastic
- Cabinet body moved from the wall by 100 mm to ensure easy wall-mounting
- Feet height: 160 mm, adjustable feet – 25 mm upwards or 5 mm downwards



811658

SINK TABLE WITH CABINET – WELDED

430

stainless steel

- Sink bowls pressed from a single sheet of stainless steel characterised by high resistance to food acids and chemicals.
- Sink bowl seamlessly welded into the worktop.
- Sink dimensions: 400x400x(H)250 mm.
- Drain compatible with standard traps: Ø50 mm.
- Tap opening Ø30 mm.
- Worktop with 10 mm recess to prevent water from flowing out.
- Welded for high durability and stability.
- Approximate maximum load per worktop – 70 kg/m².
- 40 mm backsplash prevents the walls from being stained.
- Door handles made of plastic.
- Cabinet body moved from the wall by 100 mm, no rear wall to ensure access to water and sewage connection.
- Feet height: 160 mm, adjustable feet – 25 mm upwards or 5 mm downwards.



813690

WALL WORK TABLE CABINET WITH SLIDING DOORS – WELDED

- Sliding doors mounted on roller bearings

code	mm
811641	800x600x(H)850
811658	1000x600x(H)850
811665	1200x600x(H)850
811672	1400x600x(H)850
811689	1600x600x(H)850

SINGLE SINK TABLE WITH CABINET – WELDED

- Hinged doors, hinges on the left.
- Doors are kept shut with magnetic latches.

code	mm
1 SINK BOWL, DEPTH 600 MM	
813522	600x600x(H)850
2 SINK BOWLS, DEPTH 700 MM	
813546	600x700x(H)850

DOUBLE SINK TABLE WITH CABINET – WELDED.

- Sliding doors.

code	mm
813690	1000x600x(H)850

976791



DEGREASER FOAM

- Thoroughly removes all greases, oils and dirt from grills, deep fryers, ovens, extractor hoods and tiles.
- Foam can be used on all washable, alkali-resistant surfaces.
- Not suitable for aluminum or painted surfaces!
- The thick foam is ideal for vertical surfaces.

code	liters
976791	1





811009



FURNITURES



SINGLE SINK TABLE BUDGET LINE – SCREWED

- Basin made of stainless steel (AISI 304), frame made of stainless steel (AISI 430).
- Basin depth: 300 mm.
- Embossed area – water flow towards the sink, envelope-shaped.
- With a 40mm upstand.
- Distance from the upstand to the basin: 100 mm.
- The legs are adjustable in height to guarantee level installment (+25/-5 mm).
- ø30mm opening for tap instalment, fits HENDI 970515 and 970508 taps.
- ø52mm drain compatible with standard traps.
- Flat pack delivery for self-assembly (wrench included).

code	mm
811009	800x600x(H)850
811023	1000x600x(H)850



STAINLESS STEEL CLEANER

- Clean all kinds of stainless steel and aluminum surfaces.
- Ready for use, just spray and wipe.
- Comes in a 500ml spray bottle.
- Removes fingerprints and has an anti-static effect.
- After use the treated surfaces are dirt and water repellent.

code	liters
976784	0.5



976784

304
stainless steel

430
stainless steel

430
stainless steel



811832



811207

SINGLE BASIN TABLE - WELDED

- Basin welded, made of AISI 304 stainless steel for high resistance to food acids and chemicals.
- Embossed area - drop towards the trap, envelope-shaped.
- Drain compatible with standard traps: \varnothing 50 mm.
- 40 mm backsplash to prevent water from flowing out.
- Framework and body made of standard AISI 430, dimensions 40x40 mm.
- Basin table front cover - made of AISI 430 steel.
- Welded for high durability and stability.
- Adjustable feet: +25/-5 mm.
- Tap opening: \varnothing 30 mm.

code	mm	basin size (mm)
SINGLE BASIN, DEPTH 600 MM, HEIGHT 300 MM		
811825	800x600x(H)850	686x443x(H)300
811832	1000x600x(H)850	886x443x(H)300
SINGLE BASIN, DEPTH 700 MM, HEIGHT 300 MM		
812853	800x700x(H)850	686x540x(H)300
812860	1000x700x(H)850	886x540x(H)300

WALL MOUNTED CABINET WITH SLIDING DOORS - WELDED

- Made of durable stainless steel (AISI 430).
- Equipped with sliding doors with plastic handle, all on roller bearings.
- The smooth internal surface eases cleaning.
- Maximum spread load capacity per shelf: 70 kg/m².
- Welded for high durability and stability.
- Delivered with special strip brackets for mounting on the wall.

code	mm
DEPTH 300 MM	
814154	800x300x(H)600
811207	1000x300x(H)600
DEPTH 400 MM	
814178	800x400x(H)600
814185	1000x400x(H)600
811214	1200x400x(H)600





816998



815007



TABLE WITH 1 SINK BOWL AND A SHELF – SCREWED, DEPTH: 600 MM

- Durable construction made entirely of AISI 430 stainless steel.
- Sink with the dimensions of 400x400x(H)250 mm.
- Sink bowl pressed from a single sheet of steel, seamlessly welded into the worktop.
- Drain compatible with standard traps: ø50 mm.
- A special opening for installing a Ø30 mm tap.
- A 40 mm backsplash on one side of the table protects the walls from stains.
- Non-adjustable shelf, distance from the floor to the bottom edge of the shelf: 160 mm.
- Legs made of 40x40 mm profiles.
- Screwed structure allows for folding, storage and transport of the piece of equipment.
- Piece of equipment designed for work performed in the kitchen.
- Approximate maximum load per worktop: 70 kg/m².
- Adjustable feet: +25/-5 mm.

code	mm	sink location
816998	800x600x(H)850	on the right
817001	800x600x(H)850	on the left

SINK TABLE - WELDED, 2 SINKS

- Sink bowls pressed from a single sheet of stainless steel characterised by high resistance to food acids and chemicals
- Sink bowl seamlessly welded to the worktop
- Sink dimensions: 400x400x(H)250 mm
- Drain compatible with standard traps: Ø50 mm
- Tap opening Ø30 mm
- Worktop with 10 mm recess to prevent water from flowing out
- Welded
- Feet made of 40x40 mm profiles
- 40 mm backsplash prevents the walls from being stained
- Feet legs moved from the wall by 50 mm to ensure easy wall-mounting
- Adjustable feet - 25 mm upwards or 5 mm downwards
- Approximate maximum load per worktop - 70 kg/m².
- 400x400x(H)250 mm sink.

code	mm
815007	1000x600x(H)850



TABLE WITH SINK, DISHWASHER SPACE AND SHELF

- Made of high-quality stainless steel.
- Smooth and polished surfaces and joints for safe and easy cleaning.
- Reinforced worktop (AISI 430).
- Worktop with marine edge fitted with a 40 mm backsplash, prevents the buildup of dirt between the table and the wall.
- The integrated sink (AISI 304) measures 400x400x(H)250 mm.
- Comes with a pre-drilled tap hole of \varnothing 30 mm.
- The reinforced shelf measures 575x585 mm and is non-adjustable.
- The legs (AISI 430) are made of 40x40 mm tubes and fitted with adjustable feet (+25 / -5 mm).
- Available with a sink on the left side (237519) or on the right side (237526).
- Spread load capacity: ± 70 kg/m².
- Bolted construction for self-assembly.
- Flatpack delivery.

code	-	mm
237519	left	1200x700x(H)850
237526	right	1200x700x(H)850

DEGREASER FOAM

- Thoroughly removes all greases, oils and dirt from grills, deep fryers, ovens, extractor hoods and tiles.
- Foam can be used on all washable, alkali-resistant surfaces.
- Not suitable for aluminum or painted surfaces!
- The thick foam is ideal for vertical surfaces.

code	liters
976791	1





231777



231760

LOADING TABLE WITH SINK FOR DISHWASHER

- Made of durable stainless steel, with a 510 mm wide basket guide, upstand and integrated sink (400x400 mm).
- Equipped with a catch for hood dishwashers.
- The legs are adjustable in height to guarantee level installment (+25/-5 mm).
- Flat pack delivery, needs assembly.
- Versions available for left & right side instalment.

code	-	mm
231777	left side	1200x700x(H)850
231791	right side	1200x700x(H)850

UNLOADING TABLE FOR DISHWASHERS

- Made of durable stainless steel, with a 510 mm wide basket guide and upstand.
- Equipped with a catch for hood dishwashers.
- The legs are adjustable in height to guarantee level installment (+25/-5 mm).
- Flat pack delivery, needs assemblage.
- Versions available for left & right side installment.

code	-	mm
231760	left side	1000x700x(H)850
231784	right side	1000x700x(H)850



815793



812044



MOVABLE TABLES WITH SHELF

- Made of AISI 430 stainless steel.
- Feet made of 40x40 mm profiles.
- Worktop filled from below with waterproof laminated board that reinforces and soundproofs the item.
- Steel wire shelf mounted at 200 mm, non-adjustable.
- Approximate maximum load per worktop and per shelf - 70 kg/m².
- Worktop without backsplash allows the user to use the table regardless of where they stand.
- 4 low-noise, swiveling castors Ø125 mm, two of which are equipped with a brake

code	mm
815786	1000x700x(H)850
815793	1200x600x(H)850

POT STAND

- Made of durable stainless steel (AISI 430).
- Robust welded construction guarantees stability and high durability of the stand.
- Worktop reinforced with a steel profile.
- The legs are adjustable in height to guarantee level installment (+25/-5 mm).
- Approximate maximum load per worktop (when evenly distributed): 100 kg/m².

code	mm
815151	500x500x(H)450
812044	550x550x(H)450



811108

PASS-THROUGH CUPBOARD WITH PARTITION AND SLIDING DOORS

- Made of durable stainless steel (AISI 430).
- Fitted with 2, non adjustable, removable shelves and 2 fixed shelves (bottom and middle shelf).
- Equipped with 8 sliding doors with vertical handle, all on roller bearings.
- The legs are adjustable in height to guarantee level installment (+25/-5 mm).
- Flat pack delivery, needs assembly.

code	mm
811634	800x500x(H)1800
811108	1000x600x(H)1800



812402

PASS-THROUGH CUPBOARD WITH SLIDING DOORS

- Made of durable stainless steel (AISI 430).
- Fitted with 2, non adjustable, removable shelves and 2 fixed shelves (bottom and middle shelf).
- Equipped with 4 sliding doors with vertical handle, all on roller bearings.
- The legs are adjustable in height to guarantee level installment (+25/-5 mm).
- Flat pack delivery, needs assembly.

code	mm
812402	800x700x(H)1800

WALL-MOUNTED EXTRACTOR HOOD

- Made of durable stainless steel (AISI 430).
- Equipped with a set of stainless steel labyrinth filters which can be washed in dishwashers.
- With collection pan for catching fat and grime that comes from the filters.
- Fitted with an ø200 mm ventilation connection at the top.
- The hood isn't equipped with a fan, this needs to be done separately.

code	light	mm	kg
229286	-	1000x700x(H)450	32
229293	-	1200x700x(H)450	36
229309	YES	1000x700x(H)450	35
229316	YES	1200x700x(H)450	39



229286



DISHWASHER 50X50 – ELECTRONIC CONTROL

- Extremely easy to use, clean and service
- Ideal for washing plates, cutlery, glassware, cups, trays
- Electronic control, touch control, electronic panel
- Detergent and rinse aid dispensers and pump as standard
- AISI 304 stainless steel housing
- Bottom rotating, separate plastic washing and stainless steel rinsing arms
- At the top stationary plastic wash arms, rotating stainless steel rinse arms
- Robust double-skinned door with microswitch for operation at opening
- Maximum height of glass to be cleaned: 325 mm
- Maximum height of plates to be washed: 335 mm
- Washing water temperature 60°C
- Flushing water temperature 85°C
- Boiler (capacity/power): 6 l / 6 kW
- Bath (capacity/power): 35 l / 2.8 kW
- Washing pump: 0,75 kW
- Safety thermostat for boiler/bath: up to 105°C / 99°C
- Electronic boiler and bath water thermometer
- Sealing factor of the pump: IP 44
- Vertically adjustable feet ±10 mm, ø40 mm
- Weight: 55 kg

FUNCTIONS:

- Three washing programs: 60, 120, 180 s. (The washing program can be automatically extended by the time of warming up the rinsing water to +85°C)
- Dishwasher compartment washing programme
- Can be rinsed with cold water - especially suitable for glass washing
- THERMO-PROTECTOR™ system to prevent cold flushing water - guarantees the start of rinsing at temp. 85°
- SOFT START™ system starts the water pump at a lower level pressure
- and a gradual increase in pressure to protect delicate vessels
- 8-point self-diagnostic system
- ECO system - for reduced power consumption

EQUIPMENT:

- 1 universal glass basket 500x500x(H)105 mm
- 1 basket with pins for deep and shallow plates with 5x8 pcs, 500x500x(H)105 mm
- 1 cutlery basket 110x110x(H)130 mm
- Electric detergent and rinse aid dispenser
- Water hose 1.5 m long, with ¾" female thread connection
- Drain pump
- Drain hose
- Electric cable without plug



max H
335 mm

Dishwasher 50x50
- electronic control



Floor stand





Single Pedestal Pre-Rinser

Unloading table for dishwashers

Loading table with sink for dishwasher



Trolley for dishwasher racks

Dishwasher basket for glassware

Round container body

DISPENSER AND DRAIN PUMP INCLUDED



GLASSWASHER 40X40



electromechanical control



electronic control

Separate stainless steel washing and rinsing arms at the top



Separate stainless steel washing and rinsing arms at the bottom

DISHWASHER 50X50



electromechanical control



electronic control

Separate stainless steel washing and rinsing arms at the top



Separate plastic washing arms and stainless steel rinsing arms at the bottom



code	control	basket size	voltage [V]	rinse aid dispenser	detergent dispenser	drain pump
230299	electromechanical	40x40	230	YES		
233009	electromechanical	40x40	230	YES	YES	
233016	electromechanical	40x40	230	YES		YES
233023	electromechanical	40x40	230	YES	YES	YES
230268	electronic	40x40	230	YES	YES	YES
230305	electromechanical	50x50	400	YES		
233030	electromechanical	50x50	400	YES	YES	
233047	electromechanical	50x50	400	YES		YES
233054	electromechanical	50x50	400	YES	YES	YES
237540	electronic	50x50	230	YES	YES	YES
231753	electronic	50x50	400	YES	YES	YES

		GLASSWASHER 40X40		DISHWASHER 50X50	
CONTROL		electromechanical	electronic	electromechanical	electronic
INTENDED USE		mugs, cups, glasses, cutlery, plates		plates, cutlery, glasses, mugs, trays	
WASHING PARAMETERS					
Washing cycles number/duration	s	1 – 120 ¹⁾	3/60, 120, 180 ¹⁾	1 – 120 ¹⁾	3/60, 120, 180 ¹⁾
Capacity	baskets/h	30	60/30/20	30	60/30/20
Maximum height	mm	plate 290 / glass 295		plate 325 / glass 335	
Water consumption per cycle	l	2-2,5	1,7	2-2,5	
Washing water temperature	°C	62		62	
Rinse water temperature	°C	85		85	
Boiler (capacity/power)	l / kW	3,5/2,5		6/6	
Tank (capacity/power)	l / kW	17/2,5		35/2,8	
Safety thermostat for boiler	°C	105		105	
Safety thermostat for tank	°C	99		99	
STANDARD EQUIPMENT					
Water thermometer in the boiler		electronic		analog	electronic
Separate washing/rinsing arms		washing and rinsing stainless steel arms		plastic washing arms, stainless steel rinsing arms	
Rinse aid dispenser		YES		YES	
Detergent dispenser		OPTION	YES	OPTION	YES
Drain pump		OPTION	YES	OPTION	YES
Equipment		1x universal baskets 400x400x(H)150 mm for glasses 1x basket with pins 400x400x(H)110 mm for plates 1x cutlery basket 110x110x(H)130 mm water supply hose length 1,5 m, with connection 3/4" inner thread drain hose length 2 m, Ø25 mm		1x universal baskets 500x500x(H)105 mm for glasses 1x basket with pins 500x500x(H)105 mm for plates 1x cutlery basket 110x110x(H)130 mm water supply hose length 1,5 m, with connection 3/4" inner thread drain hose length 2 m, Ø25 mm	
TECHNICAL PARAMETERS					
Dimensions (width x depth x height)	mm	470x510x(H)710		570x600x(H)830	
Power	kW	2,8		6	6,6 or 3,6 [230 V]
Pump power	KM	0,1	0,3	0,75	
Pump leakage rate		IP 44		IP 44	
Voltage	V	230		400	400 or 230
Weight	kg	39		57	55
FUNCTIONS					
Dishwasher self-cleaning programme		YES		YES	
"SOFT START" system ²⁾		YES		YES	
THERMO-PROTECTOR system ³⁾		YES		YES	
Self-diagnosis system ⁴⁾		YES		YES, 8-point	
ECO system				YES	
CONSTRUCTION					
Housing made of AISI 304 steel		YES		YES	
Double-layer insulated doors		YES		YES	
Vertically adjustable feet ø40 mm		±10		±10	
FLOOR STAND		222980		231050	
Dimensions	mm	470x500x(H)500		560x560x(H)500	
Capacity		For 2 baskets 400x400x(H)150 mm		For 2 baskets 500x500x(H)105 mm	

¹⁾ Indicated time may be extended due to the time needed for the water in the boiler to reach 85°C

DISHWASHER FUNCTIONS

²⁾ "SOFT START" – activates the water pump at a lower pressure and gradually raises the pressure to avoid damaging delicate dishes

³⁾ "THERMO-PROTECTOR" system – prevents rinsing with cold water – guarantees that rinsing will start at 85°C

⁴⁾ Self-diagnosis system for a quick check of the dishwasher condition



HOOD DISHWASHER - ELECTRONIC CONTROLLER

- Extremely easy to use, clean and service
- Ideal for washing plates, cutlery, glassware, cups, trays, GN 1/1 containers
- Electronic control
- Detergent and rinse aid dispensers and drain pump as standard
- Maximum height of washed plates 400 mm
- Maximum height of glass to be cleaned 395 mm
- Touch electronic control panel
- AISI 304 stainless steel housing
- Stainless steel upper and lower washing and rinsing arms
- Lifting of the hood facilitated by built-in springs
- Washing water temperature 60°C
- Temperature of rinsing, scalding water 85°C
- Boiler capacity and output 13.5 l / 7.5 kW
- Tank capacity and power 68 l / 6.0 kW
- Cleaning pump power 1,5 kW
- Electronic water thermometers for the boiler and bath separately
- Safety thermostat for boiler/bath up to 105°C / 99°C
- Sealing factor of the pump: IP 44
- Corner installation of dishwasher possible
- Water connection: 3/4"
- Weight: 131.5 kg
- Adjustable stainless steel feet from 100 to 150 mm

FUNCTIONS:

- Three washing programs: 60, 120, 240 s
- Dishwasher compartment washing programme
- Possibility of a final rinse with cold water - especially useful when washing glass
- „THERMO-PROTECTOR“ system to prevent rinsing with cold water
- 8-point self-diagnostic system
- „SOFT START“ function to start the water pump at a lower pressure and raise it gradually so as not to damage delicate dishes
- Door with microswitch for operation when hood is raised
- ECO function - reduces power consumption when the device is not used for more than 15 minutes

EQUIPMENT:

- 1 universal glass basket 500x500x(H)105 mm
- 1 basket with pins for deep and shallow plates with 5x8 pcs, 500x500x(H)105 mm
- 1 cutlery basket 110x110x(H)130 mm
- Rinse aid and detergent dispenser
- Drain pump
- Water hose 1.5 m long, with 3/4" female thread connection.
- Drain hose
- Electric cable without plug

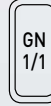

max H
400 mm

Hood dishwasher - electronic controller

Unloading table for dishwashers



Dishwasher basket
for glassware

Trolley for
dishwasher racks

**DISPENSER
AND DRAIN
PUMP
INCLUDED**

Single Pedestal Pre-Rinser

Loading table with sink
for dishwasher



Round container body 120 L



HOOD DISHWASHEER 50X50

DISHWASHERS AND HYGIENE



230312

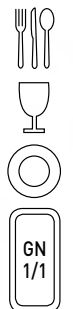

max H
400 mm



231340



Separate stainless steel washing and rinsing arms at the top



Separate stainless steel washing and rinsing arms at the bottom

code	control	basket size	voltage (V)	rinse aid dispenser	detergent dispenser	drain pump
230312	electromechanical	50x50	400	YES		
233061	electromechanical	50x50	400	YES	YES	
231340	electronic	50x50	400	YES	YES	YES

HOOD DISHWASHER 50X50

CONTROL		electromechanical	electronic
INTENDED USE		plates, cutlery, glasses, mugs, trays, GN containers	
WASHING PARAMETERS			
Washing cycles number/duration	s	1 – 120 ¹⁾	3/60, 120, 180 ¹⁾
Capacity	baskets/h	30	60/30/15
Maximum height	mm	glass 395 / plate 400	
Water consumption per cycle	l	2-2,5	1,7
Washing water temperature	°C	62	
Rinse water temperature	°C	85	
Boiler (capacity/power)	l / kW	7,4/7,5	13,5/7,5
Tank (capacity/power)	l / kW	68/6	
Safety thermostat for boiler	°C	105	
Safety thermostat for tank	°C	99	
STANDARD EQUIPMENT			
Electronic touch control panel			YES
Water thermometer in the boiler and the basin		analog	electronic
Separate washing/rinsing arms		stainless steel washing and rinsing arms at the bottom and top	
Rinse aid dispenser		YES	
Detergent dispenser		OPTION	YES
Equipment		1x universal basket 500x500x(H)105 mm for glasses 1x basket with pins 500x500x(H)105 mm for plates 1x cutlery basket 110x110x(H)130 mm	
Surface filters above water level in the basin		4 pcs	
Additional screen in front of the pump inlet		YES	
Water supply hose, length 1.5 m, with 3/4" female thread		YES	
Power cord without plug		YES	
TECHNICAL PARAMETERS			
Dimensions (width x depth x height)	mm	750x880x(H)1390/1830	
Power	kW	8,6	
Pump power	KM	1,5	
Pump leakage rate	kW	IP 44	
Voltage	V	400	
Weight	kg	111	131,5
FUNCTIONS			
Dishwasher self-cleaning programme			YES
"SOFT START" system ²⁾			YES
THERMO-PROTECTOR system ³⁾			YES
Self-diagnosis system ⁴⁾			YES, 8-point
ECO system			YES
Door with microswitch for operation with the hood raised			YES
CONSTRUCTION			
Housing made of AISI 304 steel		YES	
Double-layer insulated doors		YES	
Vertically adjustable feet	mm	from 100 to 150 mm	

¹⁾ Indicated time may be extended due to the time needed for the water in the boiler to reach 85°C

DISHWASHER FUNCTIONS

²⁾ "SOFT START" – activates the water pump at a lower pressure and gradually raises the pressure to avoid damaging delicate dishes

³⁾ "THERMO-PROTECTOR" system – prevents rinsing with cold water – guarantees that rinsing will start at 85°C

⁴⁾ Self-diagnosis system for a quick check of the dishwasher condition



50X60 DISHWASHER FOR TRAYS AND POTS – ELECTRONICALLY CONTROLLED, WITH DETERGENT DOSING SYSTEM AND DRAIN PUMP



DISHWASHERS AND HYGIENE



- Specialised dishwasher, perfect for washing and scalding pots, GN containers, 600x400 mm confectionery trays, flasks, trays or cutlery.
- 3 electronically controlled washing cycles: 120s, 180s, 240s.
- Scalding temperature: 82°C.
- Washing temperature: 60°C.
- Boiler capacity/power: 7.4 L/6 kW.
- Basin capacity/power: 58 L/6 kW.
- Electronic touch panel.
- Automatic cleaning system.
- Pump tightness coefficient: IP 44.
- Large basket: 500x600 mm.
- Two-layer housing made of AISI 304 stainless steel.
- Washing and rinsing arms made of stainless steel.
- Weight: 57 kg.

- EQUIPMENT:
- Detergent dispenser.
- Rinse aid dispenser.
- Electronic thermometer in boiler.
- Electronic thermometer in basin.
- 1,2 kW washing pump.
- Drain pump.
- Plate basket 500x600x(H)105 mm.
- Universal basket 500x600x(H)105 mm.
- Cutlery basket 110x110x(H)130 mm.

code	V	W	mm
236574	400	7100	595x730x(H)1340

NEW



GREASE TRAP

- Prevents grease from blocking the sewer system.
- For indoor use (dishwashing areas, kitchens).
- Compact size, completely made from stainless steel.
- The gasketed lid secured in place with four clamps.
- Water in & out connections Ø50 mm.
- Two vertical interior baffles separating grease and silt.
- Grease removal drain fitted with a ball valve.

code	-	liters	mm
975718	300l/h	30	650x346x(H)308
975725	600l/h	60	728x416x(H)398
979945	1800l/h	180	903x548x(H)629



GREASE FILTER FOR DEEP FRYER - 50 PCS

- Made of rayon (synthetic silk).

code	packed per	mm
632802	50	254x254



GREASE FILTER HOLDER FOR DEEP FRYER

code	mm
632901	ø250x(H)240



BUCKET

- Suitable for storing frying oil and sauces
- Made of white polypropylene
- High heat resistance - can be filled with liquids at temperatures between 85-95°C
- Comfortable plastic handle
- Polypropylene lid (included)
- Side surface suitable for offset printing or labeling
- Useable volume: 11.3 l ± 120 ml
- Printable / labeling area: 810 x 155 mm
- Stackable (max load capacity of lower bucket: up to 45 kg)
- Weight (with handle and lid): 430 g

code	liters	mm
196007	11.5	ø300x(H)230





NEW



970300

SINGLE PEDESTAL PRE-RINSER

- Single pedestal pillar tap.
- Rinser resistant to high pressure water flow.
- Maximum water flow: 17 L/min. at a pressure of 4 bar.
- Plastic rinser handle.
- Adjustable column support.
- Wall mount (optional shortening).
- Connection hoses: 1/2", 400 mm long each.
- Table hole required: Ø 27 mm.

code

970300



810255

PULL-OUT BASIN TAP

- Made from stainless steel
- Single hole, rotary spout
- Stream control
- Shower length: 150 cm
- Required table opening: 32 mm
- Connector hoses: 3/8", length: 350 mm
- Spout range: 230 mm
- Tap height: 230 mm

code

810255

DISHWASHERS AND HYGIENE



NEW



970508

SINK TAP

- Single-hole, separate knobs for hot and cold.
- Connection hoses: 1/2".
- Mounting hole required: Ø30 mm.
- Swivel spout, radius 250 mm.

code

970508



NEW



970522

SINK TAP WITH LONG LEVER

- Long lever for mixing hot and cold water.
- Connection hoses: 3/8".
- Mounting hole required: Ø35 mm.
- Swivel spout, radius 215 mm.

code

970522



970515

TAP WITH PULL OUT RINSER

- Single-hole pillar tap.
- Rinser resistant to high pressure water flow.
- Plastic rinser casing.
- Adjustable column support.
- Wall mount (optional shortening).
- Connection hoses: 1/2".
- Table hole required: Ø 30 mm.
- Spout reach 280 mm.

code	mm
970515	



810316



WASHBASIN KNEE OPERATED

- Made of stainless steel, button made from chrome plated plastic and the valve from copper.
- The basin has a diameter of 350 mm and a depth of 123 mm.
- Easy to operate with a knee.
- Connecting materials included.

code	mm
810316	400x400x(H)450



With knee-operated faucet

810309

KITCHEN SINK - WITH KNEE-OPERATED FAUCET

- Turn on the water in a hygienic way by simply pressing your knee against the front panel.
- Equipped with hot and cold water mixer which is located under the front panel.
- Basin and backsplash made of 18/10 stainless steel.
- Comes with spout and soap dispenser.
- Front panel dimensions: 285x(H)185 mm.
- Sink dimensions: 330x230x(H)120 mm.
- Water connection: 1/2", drain hole Ø 52 mm.

code	mm
810309	400x335x(H)570



DISHWASHER RACKS & TOTE BOX PROFI LINE

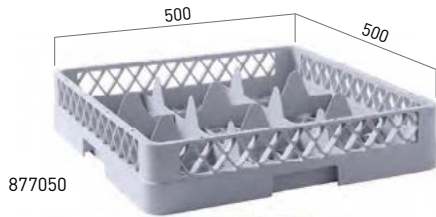

877050



877043



877036



877029



877012

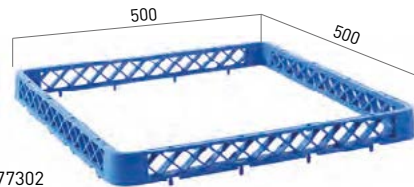

877302



877548



877531



877524



877517



877500

DISHWASHER BASKET FOR GLASSWARE

code		mm
877050	9 compartments	500x500x(H)104
877043	16 compartments	500x500x(H)104
877036	25 compartments	500x500x(H)104
877029	36 compartments	500x500x(H)104
877012	49 compartments	500x500x(H)104

EXTENDER FOR DISHWASHER BASKET

- For use with HENDI dishwasher baskets.
- Once installed not removable without breaking.

code		mm
877302	1 compartment	500x500x(H)45
877548	9 compartments	500x500x(H)45
877531	16 compartments	500x500x(H)45
877524	25 compartments	500x500x(H)45
877517	36 compartments	500x500x(H)45
877500	49 compartments	500x500x(H)45

DISHWASHERS AND HYGIENE

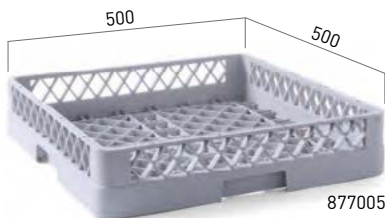

877005

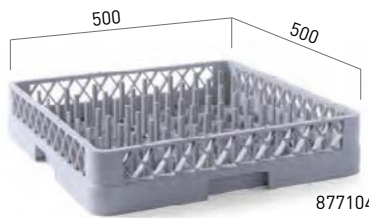

877104

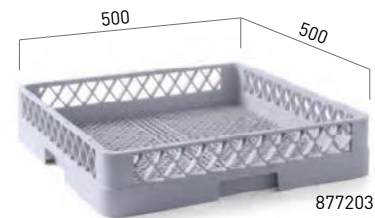

877203

DISHWASHER UNIVERSAL BASKET

- Suitable for cups, pots, bowls, etc.
- The structure allows for maximum flow of water between the dishes in all directions
- With coarse mesh bottom

DISHWASHER BASKET FOR PLATES

- The structure allows for maximum flow of water between the dishes in all directions.
- With pre-shaped pins.
- The spaces between separators create the optimum tilt of plates necessary for effective washing.

DISHWASHER BASKET FOR CUTLERY

- The structure allows for maximum flow of water between the dishes in all directions.
- The fine mesh bottom prevents cutlery from falling through.

code	mm
877005	500x500x(H)100

code	mm
877104	500x500x(H)100

code	mm
877203	500x500x(H)100

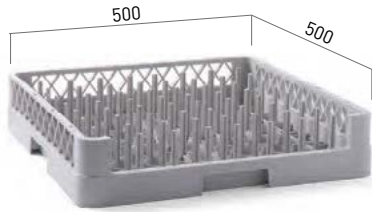

877111



DISHWASHER BASKET FOR TRAYS

- The structure allows for maximum flow of water between the trays in all directions.
- With pre-shaped pins.
- With one open end for trays and other long items.

code	mm
877111	500x500x(H)100

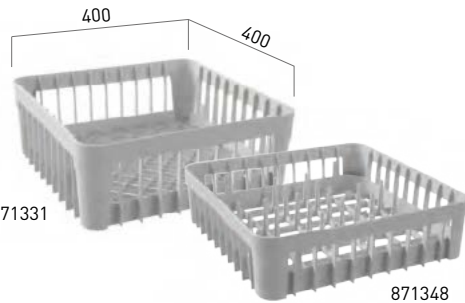

871331



871348

DISHWASHER BASKET FOR GLASSES

- The structure allows for maximum flow of water between the glasses in all directions.

code	-	mm
871331		400x400x(H)150
871348	with 20 support pins	400x400x(H)110



810583

MOBILE TROLLEY FOR DISHWASHER BASKETS - 7 X 500X500 MM

- For dishwasher baskets 500x500 mm.
- Keep the work area around the dishwasher organised.
- 7 layers - basket supports interspaced at 200 mm.
- Fitted with basket locks on both sides.
- Fitted with four castors of which two have brakes.
- Flatpack delivery.
- Permissible cart load capacity with uniform weight distribution - 100 kg.

code	mm
810583	615x560x(H)1700



871102

CUTLERY BASKET

- 8 sections with handle.

code	mm
871102	425x205x(H)150



871300

871324



CUTLERY BASKET

code	mm
871300	110x110x(H)140

CUTLERY BASKET

code	mm
871324	125x84x(H)135



877180

LID FOR RACKS

code	mm
877180	500x500



877197



TROLLEY FOR DISHWASHER RACKS WITH HANDLE

- 4 wheels, 2 revolving with brake and 2 fixed.
- Stainless steel handle.

code	mm
877197	575x545x(H)920



877173



TROLLEY FOR DISHWASHER RACKS

- 4 wheels, 2 revolving with brake and 2 fixed.

code	mm
877173	575x545x(H)210



NUMBER OF EGGS

30



281208

EGG STERILIZER, 30 EGGS

- Indispensable for each kitchen in school, hotel, restaurant, canteen or pastry shop.
- Disinfects 30 eggs at a time.
- UV resistant grid fixed in bearing drawer.
- Eggs get sterilized in a process of irradiation with waves of 253,7 nm length.
- Irradiation (sterilization) takes around 2,30 minutes.
- Eggs can be used right after the disinfection process.
- Lamps are turned off automatically when opening the drawer.
- Stainless steel casing.
- Bearing-mounted egg rack made of stainless steel.
- UV radiator life: 7500 h.

code	-	V	W	mm
281208	30 eggs	230	78	358x512x(H)255



281246

UV STERILIZER

- Perfect for sterilizing knives, capacity for 14 knives.
- Made of stainless steel with plexiglass door.
- Fitted with stainless steel knife holder.
- Sterilizes by means of bactericidal ultraviolet light.
- Equipped with a microswitch to prevent operation while the door is open.
- Integrated timer adjustable up to 60 minutes.
- Accommodates the maximum size knives:
 - handle length - max 150 mm,
 - blade length - max 350 mm,
 - grip thickness - min 15 mm.

code	V	W	mm
281246	230	25	510x160x(H)610



CHEF'S HAT - 10 PCS

- Pleated nonwoven PP material.
- Perforated crown.
- Adjustable size

code	mm
560044	ø600x(H)230



221808

HAND DRYER

- Electric activation by motion detector.
- Fitted with lead and plug Impact resistant metal casing in white epoxy finish.

code	V	W	mm
221808	230	1500	240x210x(H)265



663950

WET FLOOR SIGN

- Warning in 5 languages.

code	mm
663950	300x460x(H)615



691083



LAUNDRY TROLLEY

- Stainless steel structure with removable laundry bag.
- The laundry bag is made of oxford fabric and it is washable.
- 4 wheels of which 2 are castor wheels.

code	mm
691083	900x650x(H)850

LAUNDRY BAG FOR LAUNDRY TROLLEY

- Laundry bag for HENDI Laundry trolley 691083.
- Made of Oxford fabric.
- Can be cleaned in a washing machine.

code
691090



Foot-operated clamping mechanism keeps the bag closed



691021



944660



TRASH BAG HOLDER

- Frame made of stainless steel.
- Intended for 60x90 cm, 70/80L garbage bags.
- Foot-operated clamping mechanism keeps the bag closed.
- 2 castor wheels with brakes.

code	mm
691021	420x580x(H)960
944660	Rubber band for Trash bag holder



691120



TRASH BIN 43 L

- Made of stainless steel.
- With swivel lid.

code	mm
691120	360x360x(H)740



NEW



DISHWASHERS AND HYGIENE



691038

ROUND CONTAINER BODY

code	liters	mm
691038	120	ø550x(H)690
691403	80	ø490x(H)620



691045

ROUND LID

code	-	mm
691045	fits 691038	ø570x(H)35
691410	fits 691403	ø505x(H)35



691052

ROUND OPEN COVER

code	-	mm
691052	fits 691038	ø570x(H)135
691427	fits 691403	ø510x(H)120



691069

FLIP OPEN COVER

code	-	mm
691069	fits 691038	ø580x(H)190
691434	fits 691403	ø505x(H)190



691076

ROUND TROLLEY

code	-	mm
691076	fits 691038	ø455x(H)165
691441	fits 691403	ø400x(H)165



AMER★BOX®

NEW



691151

STEP-ON CONTAINER

code	liters	mm
691151	68	490x410x(H)660
691168	87	500x410x(H)815



691137

SLIM RECTANGLE CONTAINER 60L

code	liters	mm
691137	60	455x315x(H)580

BINS AND ASHTRAY STANDS

- Stainless steel body Polished surface finish Comfortable, hygienic opening Anti-slip pedal Innovative "click-lock" system

locking the lid after opening Polypropylene inner bin - flexible, with a double handle to keep the bin liner in place



Removable ashtray for easy cleaning and emptying of the bin

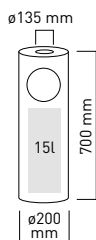

691380



STANDING WASTE BIN WITH ASHTRAY

code	liters	mm
691380	15	ø200x(H)700



Removable ashtray for easy cleaning and emptying of the bin

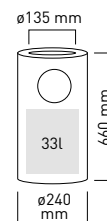

691397



STANDING WASTE BIN WITH ASHTRAY

code	liters	mm
691397	33	ø240x(H)660





976739

COFFEE AUTOMAT CLEANER, 120 TABS

- The coffee automat cleaner is suitable for regular use in coffee, espresso and tea machines.
- Removes stubborn deposits such as coffee or tea oil.
- Can also be used for cleaning thermo flasks.
- Use regularly to keep your appliances in perfect condition, and prevent replacement costs.

code	weight (kg)
976739	0.24



976777

DESCALER POWDER

- Concentrated, professional descaling agent.
- Removes limescale deposits on commercial dishwashers, hot water devices, coffee machines and washing machines (washing program 40°C).
- Can also be used to clean stainless steel surfaces.
- Use regularly to keep your appliances in perfect condition, and prevent replacement costs.

code	weight (kg)
976777	1



976753

COFFEE MACHINE CLEANER

- The coffee machine cleaner is suitable for regular use in coffee, espresso and tea machines.
- Removes stubborn deposits such as coffee or tea oil.
- Use regularly to keep your appliances in perfect condition, and prevent replacement costs.

code	liters
976753	1



976760

DESCALER CONCENTRATE

- Highly concentrated, based on citric acid for the effective decalcification of hot water devices, coffee and washing machines, boilers, stainless steel pots and tiles.
- 1 liter bottle, dosage 100-200 ml per 1 liter of cold water.
- Use regularly to keep your appliances in perfect condition, and prevent replacement costs.

code	liters
976760	1



976746

SOFT SERVE AND WHIPPED CREAM MACHINE CLEANER

- Cleaner for all common cream & ice cream makers.
- Dissolves fat and protein residues.
- Can also be used on the outer surfaces of the device.
- Use regularly to keep your appliances in perfect condition, and prevent replacement costs.

code	liters
976746	1



STAINLESS STEEL CLEANER

- Clean all kinds of stainless steel and aluminum surfaces.
- Ready to use, just spray and wipe.
- Comes in a 500ml spray bottle.
- Removes fingerprints and has an anti-static effect.
- After use the treated surfaces are dirt and water repellent.

code	liters
976784	0.5



976784



NEW

DEGREASER FOAM

- Thoroughly removes all greases, oils and dirt from grills, deep fryers, ovens, extractor hoods and tiles.
- Foam can be used on all washable, alkali-resistant surfaces.
- Not suitable for aluminum or painted surfaces!
- The thick foam is ideal for vertical surfaces.

code	liters
976791	1



976791



975039

PROFESSIONAL GRILL AND OVEN CLEANER

- Ready-to-use, strongly alkaline product for daily removal of oily and tarry deposits, burnt grease and organic discolourations.
- Cleans and degreases.
- Recommended for daily washing of grill, ovens, hoods.
- Helps keep the natural shine of surface.
- Fragrance free.
- pH 14.

code	liters
975039	1



WATER SOFTENERS (SEMI-)AUTOMATIC

- Using water softeners helps extend the life cycle of catering equipment.
- The softeners are based on an ion-exchange process wherein the calcium and magnesium ions that cause water hardness are captured by ion exchange resin inside the softener.
- It helps reduce maintenance costs thanks to effective prevention of lime scale deposits. The device is fitted with a control head that makes it possible to configure working parameters of the water softening system as required.
- The elements inside the head are made of high quality ceramics, resistant to abrasion, corrosion and build-up of impurities (e.g. iron).
- This technology assures perfect seal inside the controller and

- therefore long and trouble-free operation.
- Navy blue housing.
- Water connection diameter 3/4".
- Working pressure: 1.5-6.0 bar.
- Working ambient temperature: 5 – 38°C.
- Max. supply water temperature: 38°C.
- Regeneration time: 37 min.
- Output for 10°dH – 1200 L.
- Resin bed 4,0 L.
- Regeneration tank: 8 kg.
- Maximum water flow: 5 L/min.
- Regeneration salt consumption per 1 cycle: 0.5 kg.



230442



230459

WATER SOFTENER, SEMI-AUTOMATIC

- The semi-automatic resin bed regeneration process using brine is initiated manually.

- Weight: 8 kg.

code	V	W	mm
230442	230	18	195x360x(H)510

WATER SOFTENER, AUTOMATIC

- The automatic resin bed regeneration process using brine is initiated automatically.
 - Using the control panel the working time, regeneration time and water amount to be treated can be set.
 - Automatic lock prevents unwanted access.
- Weight: 7.7 kg.

code	V	W	mm
230459	230	18	206x380x(H)480

SALT TABLETS FOR WATER SOFTENING

- Ingredients: sodium chloride NaCl.
- Bag 25 kg.

code	weight (kg)
231265	25

231265



WATER SOFTENERS MANUAL

- Hard water contains dissolved minerals - calcium and magnesium compounds, among others. Calcium and magnesium ions cause scale build-up, which is risky for objects and tools in contact with water or steam.
- Water softening is a process in which all calcium and magnesium compounds causing water hardness are removed.
- When passing through the resin column, calcium and magnesium ions are absorbed by resin particles.
- When ion-exchange ability of the resin wears off, it ought to be restored in an appropriate regeneration process with the use of a salt solution.

- Water softener may be installed wherever water temperature is below 45°C and the water input pressure does not exceed 2 bars
- Regeneration: uniodised salt only.
- For drinking water only.
- Suitable for softening water for coffee makers, combi steamers, dishwashers and ice cubers.
- Thanks to its small size it is perfect for bars and restaurants.
- Thanks to highest quality components used, the device remains fail-safe and operational for many years.
- Optimum working water pressure: 1-2 bar.

WATER SOFTENER

- During softener regeneration the connected machine must not be used.
- Maximum/minimum water pressure: from 1 to 8 bar.
- Nominal flow: 1000 L/h.
- Ambient temperature: from 4 °C to 35 °C.
- Supply water temperature: from 4 °C to 25 °C.
- Connection size: 3/8".

code	Filter capacity (20°F/30°F/40°F)	liters	mm
231210	1200/1000/900	8	ø185x(H)400
231227	2520/1680/1260	12	ø185x(H)500
231234	3360/2240/1680	16	ø185x(H)600



INSECT KILLERS FOR USE IN THE KITCHEN & RESTAURANT



270080

INSECT KILLER WITH ADHESIVE PLATE 100 M²

- Suitable for use in food preparation and serving areas.
- Metal casing including wall mounting.
- 2x15 W UV-A shatter-proof fluorescent tubes.
- Adhesive plate at the rear to catch the insects.
- Maximum range approx. 100 m².
- Adhesive plate included.

code	V	W	mm
270080	230	30	480x100x(H)285
270073	Adhesive plate for Insect killers - 10 sheets		
270028	2 Replacement lamps for Insect killers		

INSECT KILLERS FOR INDOOR USE



270097

INSECT KILLER 300 M²

- Makes use of durable UV-A LED light, average working life of 20.000 hours.
- Body made of fire resistant.
- ABS for high safety.
- Insects are electrocuted with 4000 V.
- Removable collection tray, easy to clean.
- Can be mounted to ceiling by chain or used free standing.

code	V	W	mm
270097	230	13	470x100x(H)263

DISHWASHERS AND HYGIENE



270172

270165

270158



HIGH VOLTAGE INSECT KILLER

- For indoor use.
- Body made of special treated aluminum alloy and ABS, fire resistant materials for high safety.
- 2x UV-A tubes.
- Insects are electrocuted with 2000 - 2500 V.
- Removable collection tray, easy to clean.
- Can be mounted to ceiling by chain or used free standing.

code	V	W	mm
270158	230	26	335x90x(H)260
270165	230	40	485x90x(H)310
270172	230	45	640x90x(H)360



Chain included



Removable collection tray



INSECT KILLER WITH ADHESIVE PLATE 120 M²

- Suitable for use in food preparation and serving areas.
- ABS fire-resistant casing, back panel of metal, suitable for wall mounting.
- 1x36 W UV-A shatter-proof fluorescent tubes.
- Adhesive plate at the rear to catch the insects.
- Lamp and adhesive plate are easily replaceable.
- Maximum range approx. 120 m².
- Adhesive plate (390x270 mm) included.

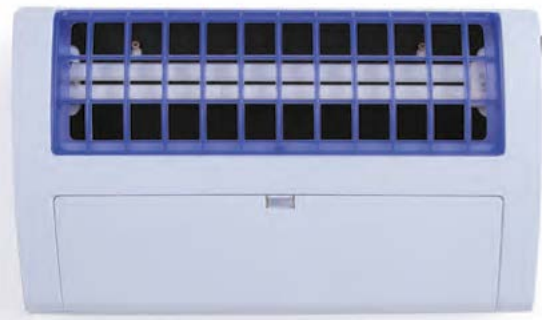

270196

code	V	W	mm
270196	230	36	475x80x(H)283
270233	Adhesive plate for Insect killers - 10 sheets		
270240	Replacement lamp for Insect killers		



INSECT KILLERS FOR OUTDOOR USE



270066

INSECT KILLER WATER RESISTANT

- ABS fire proof material for high safety.
- 2x UV-A tube.
- Insects are electrocuted with 2000 V.
- IPX4 waterproof, can be used indoor or outdoor.
- Removable collection tray, easy to clean.
- Chain mounting.

code	-	V	W	mm
270066	100 m ²	230	40	510x105x(H)315
270141	150 m ²	230	45	680x135x(H)310
935286	Replacement lamps for fly killers - set of 2			



Chain included



Removable collection tray

REPLACEMENT LAMP FOR FLY KILLERS

- UV-A fluorescent tube.

code	For	V	W	mm
934159	270158	230	8	285x15x(H)15
934166	270172 - 270141	230	20	570x20x(H)20



934159



PROFI LINE



PORCELAIN, CUTLERY, TABLEWARE



PROFI LINE

- Elegant yet sturdy.
- Hand polished, high gloss mirror finish.

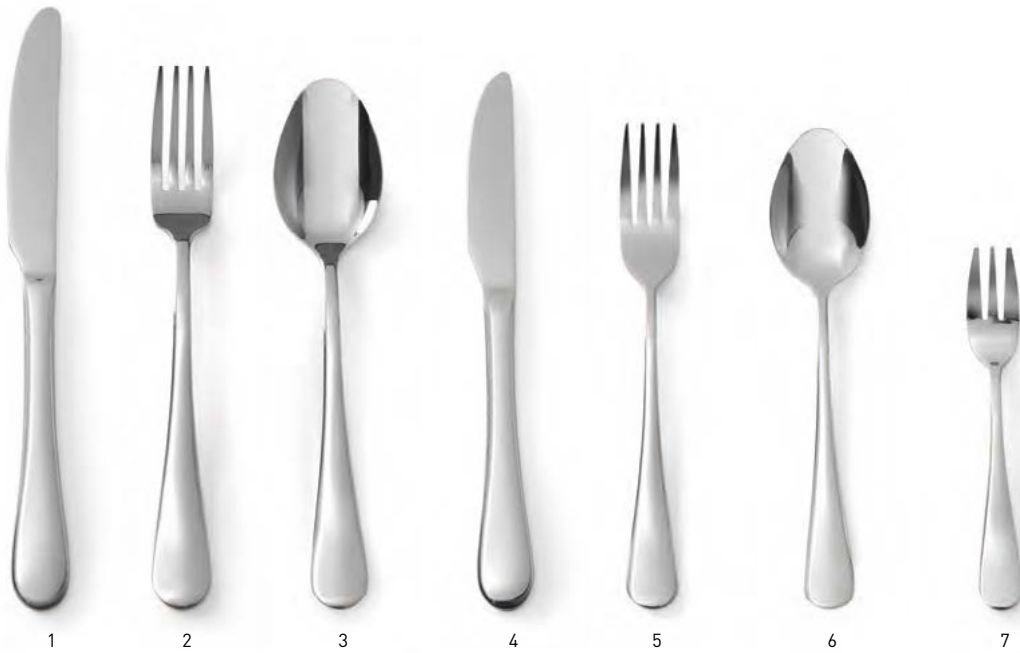

code	Nº			length (mm)
764404	1	Table knife	6 pcs	225
764411	2	Table fork	6 pcs	205
764428	3	Table spoon	6 pcs	205
764435	4	Dessert knife	6 pcs	205
764442	5	Dessert fork	6 pcs	186
764459	6	Dessert spoon	6 pcs	186
764466	7	Cake fork	12 pcs	136

code	Nº			length (mm)
764473	8	Coffee spoon	12 pcs	111
764480	9	Tea spoon	12 pcs	138
764497	10	Ice spoon	12 pcs	135
764503	11	Sundae spoon	6 pcs	198
764510	12	Butter knife	12 pcs	158
764527	13	Steak knife	6 pcs	215





KITCHEN LINE

- Hand polished mirror finish.



code	N°		length (mm)
764206	1	Table knife	6 pcs 215
764213	2	Table fork	6 pcs 197
764220	3	Table spoon	6 pcs 197
764237	4	Cake fork	12 pcs 150
764244	5	Tea spoon	12 pcs 146
764251	6	Coffee spoon	12 pcs 131
764268	7	Sorbet spoon	6 pcs 198





BUDGET LINE

- Machine polished

18/0
stainless steel



code	N°			length (mm)
764039	1	Table spoon	12 pcs	181
764022	2	Table fork	12 pcs	183
764015	3	Table knife	12 pcs	212
764084	4	Tea spoon	24 pcs	136
764091	5	Coffee spoon	24 pcs	110
764077	6	Cake fork	24 pcs	145
764138	7	Sorbet spoon	12 pcs	198



STEAK CUTLERY

- Stainless steel with ABS handle.



781432

STEAK FORK - 6 PCS

code	packed per	mm
781432	6	(L)200



781449

STEAK KNIFE - 6 PCS

code	packed per	mm
781449	6	(L)215



781456

STEAK KNIFE XL - 6 PCS

code	packed per	mm
781456	6	(L)250



403747



NUT AND SEAFOOD CRACKER MATT BLACK

- Ideal for cracking nuts, but also very suitable for sea food.
- Finished with a black powder coating.
- The large handle fits nicely in the hand and provides plenty of grip.
- The two halves are connected by a durable hinge, suitable for multiple sizes of nuts.
- Not dishwasher safe.

code	mm
403747	160x35



403716

LOBSTER FORKS - 6 PCS

code	packed per	mm
403716	6	(L)205

18/0
stainless steel



403754



LOBSTER AND CRAB CRACKER

- Ideal for opening hard lobster and crab shells.
- Wide, appropriately contoured handle for easy and comfortable use.
- Robust aluminium construction, powder coated - red.
- The arms of the tongs are connected with a durable hinge.
- Not dishwasher safe.

code	mm
403754	140x62



402528

SNAIL TONGS - 2 PCS

- Squeeze model.

code	packed per	mm
402528	2	(L)170

S.S.
stainless steel



402221

SNAIL FORK - 6 PCS

code	packed per	mm
402221	6	(L)130

18/0
stainless steel



505168

SERVING BOARD, OLIVE WOOD, RECTANGULAR*

- Ideal for serving and presenting food.
- Comfortable, carved handles.
- Available in 3 sizes.

code	mm
505168	250x150x(H)18
505175	300x150x(H)18
505182	350x150x(H)18



505212

SERVING BOARD, OLIVE WOOD, RECTANGULAR, WITH GROOVE*

- Ideal for serving and presenting food.
- Natural, organic board shape and perfect craftsmanship.
- Comfortable, carved handles, with groove.
- Available in 2 sizes.

code	mm
505199	300x210x(H)18
505212	400x250x(H)18



505229

SERVING BOARD, OLIVE WOOD, RECTANGULAR, WITH OPENING*

- Ideal for serving and presenting food.
- Natural, organic board shape and perfect craftsmanship.
- With an opening for convenient carrying of the board.
- Available in 2 sizes.

code	mm
505229	250x165x(H)18
505236	350x210x(H)18



505243

SERVING BOARD, OLIVE WOOD, RECTANGULAR, WITH HANDLE*

- Ideal for serving and presenting food.
- With a comfortable handle for easy carrying of the board.
- Available in 3 sizes.

code	mm
505243	350x120x(H)18
505250	400x140x(H)18
505267	600x200x(H)18



505274

OLIVE WOOD HOLDER*

- Ideal for serving and presenting food, bringing cutlery, etc.
- With convenient cut-out handles for easy carrying of the holder.

code	mm
505274	245x198x(H)194

* Product made of natural wood.
Image may differ from the actual product.



KARIZMA



PORCELAIN, CUTLERY, TABLEWARE



KARIZMA

- White hotel porcelain
- Strengthened edges, high quality glazing
- High impact and wear resistance



DINNER PLATE

code	order unit	mm
795101	12	ø160
795309	12	ø200
795507	12	ø240
795705	6	ø280
795903	6	ø320



DEEP PLATE

code	order unit	mm
794500	6	ø300



BUFFET PLATTER, OVAL

code	order unit	mm
796306	6	290x200
796405	6	340x235



SALAD BOWL

code	order unit	mm
796603	12	ø150
796702	12	ø190
796801	6	ø250



SOUP BOWL

code	order unit	liters	mm
798805	12	0.38	ø120

SAUCER FOR SOUP BOWL

code	order unit	mm
798904	12	ø180



CAPPUCCINO CUP

code	order unit	liters	mm
798249	12	0.23	ø85

SAUCER FOR CAPPUCCINO CUP

code	order unit	mm
798171	12	ø149



COFFEE CUP

code	order unit	liters	mm
798164	12	0.17	ø80

SAUCER FOR COFFEE CUP

code	order unit	mm
798171	12	ø149



ESPRESSO CUP

code	order unit	liters	mm
798010	12	0.09	ø64

SAUCER FOR ESPRESSO CUP

code	order unit	mm
798034	12	ø125



FLORA

PORCELAIN, CUTLERY, TABLEWARE



FLORA

- White hotel porcelain
- Strengthened edges, high quality glazing
- High impact and wear resistance



DINNER PLATE

code	order unit	mm
787007	12	ø160
787014	12	ø200
787021	12	ø255
787038	12	ø270
787045	6	ø300



SOUP PLATE

code	order unit	mm
787052	12	ø235



OVAL DISH

code	order unit	mm
787069	6	280x180
787076	6	330x225



MUESLI/SALAD BOWL

code	order unit	liters	mm
787083	12	0.25	ø145x(H)45
787090	6	1	ø230x(H)65



SOUP BOWL

code	order unit	liters	mm
787267	12	0.25	ø100

SAUCER FOR SOUP BOWL

code	order unit	mm
787182	12	ø158



CAPPUCCINO CUP

code	order unit	liters	mm
787175	12	0.25	ø87

SAUCER FOR CAPPUCCINO CUP

code	order unit	mm
787151	12	ø138



COFFEE CUP

code	order unit	liters	mm
787144	12	0.18	ø82

SAUCER FOR COFFEE CUP

code	order unit	mm
787151	12	ø138



ESPRESSO CUP

code	order unit	liters	mm
787113	12	0.12	ø65

SAUCER FOR ESPRESSO CUP

code	order unit	mm
787120	12	ø130



SATURN



PORCELAIN, CUTLERY, TABLEWARE



SATURN

- White hotel porcelain.
- Strengthened edges, high quality glazing.
- High impact and wear resistance.



DINNER PLATE

code	order unit	mm
794319	12	ø200
794326	12	ø240
794333	12	ø260
794340	6	ø280
794357	6	ø300
794364	6	ø320



SOUP PLATE

code	order unit	mm
794395	12	ø220
794517	6	ø300



BUFFET PLATTER, OVAL

code	order unit	mm
794371	6	290x200
794388	6	340x240

SALAD BOWL

code	order unit	mm
794470	6	ø250
794463	12	ø150
794524	12	ø190



SOUP BOWL

code	order unit	liters	mm
794449	12	0.38	ø120



MUG

code	order unit	liters
794531	12	0.22

SAUCER FOR SOUP BOWL

code	order unit	mm
794456	12	ø190



CAPPUCCINO CUP

code	order unit	liters	mm
794487	12	0.23	ø87



COFFEE CUP

code	order unit	liters	mm
794401	12	0.17	ø79



ESPRESSO CUP

code	order unit	liters	mm
794425	12	0.09	ø63

SAUCER FOR CAPPUCCINO CUP

code	order unit	mm
794418	12	ø150

SAUCER FOR COFFEE CUP

code	order unit	mm
794418	12	ø150

SAUCER FOR ESPRESSO CUP

code	order unit	mm
794432	12	ø125

DELTA

PORCELAIN, CUTLERY, TABLEWARE



DELTA

- White hotel porcelain.
- Strengthened edges, high quality glazing.
- High impact and wear resistance.



DINNER PLATE

code	order unit	mm
794050	12	ø160
794067	12	ø200
794074	12	ø240
794081	12	ø270
794098	6	ø300



SOUP PLATE

code	order unit	mm
799420	12	ø230



PASTA PLATE

code	order unit	mm
799406	6	ø260
799413	6	ø300

OVAL DISH

code	order unit	mm
799437	6	290x200
799444	6	340x240



SOUP BOWL

code	order unit	liters	mm
799383	12	0.34	ø160



SALAD BOWL

code	order unit	mm
799451	12	ø120
799468	6	ø140
799475	1	ø230
799482	1	ø270

SAUCER FOR SOUP BOWL

code	order unit	mm
799390	12	ø170



CAPPUCCINO CUP

code	order unit	liters	mm
799147	12	0.23	ø90



COFFEE CUP

code	order unit	liters	mm
799130	12	0.17	ø80



ESPRESSO CUP

code	order unit	liters	mm
799161	12	0.09	ø63

SAUCER FOR CAPPUCCINO CUP

code	order unit	mm
799154	12	ø145

SAUCER FOR COFFEE CUP

code	order unit	mm
799154	12	ø145

SAUCER FOR ESPRESSO CUP

code	order unit	mm
799178	12	ø83

ENAMELLED

- Enamelled tableware has made a comeback.
- White enamelled steel with a nice blue border.
- High quality enamel.
- Abrasion resistant.



621202



621226



621257

BOWL RECTANGULAR

- Dishes and desserts can be prepared in the bowl.

code	mm
621219	215x160
621202	175x130

FLAT PLATE

code	mm
621226	ø200
621233	ø240

DEEP PLATE

code	mm
621271	ø240
621240	ø180
621257	ø200
621264	ø220



621288



621295



621318

SALAD BOWL

code	mm
621288	ø160x(H)75

MUG

code	liters	mm
621295	0.36	ø90x(H)80
621301	0.52	ø100x(H)90

CUP

code	liters	mm
621318	0.12	ø70x(H)50



621332

TUMBLER

code	liters	mm
621325	0.3	ø90x(H)90
621332	0.4	ø90x(H)120





625804



625705

SOUP & GRAVY PAN - WITH LID

- Enamelled.
- Flanged stainless steel rim.
- Low lid.

code			liters	mm
625804		blue	0.5	ø115x(H)95
625705		black	0.65	ø135x(H)110



ENAMELLED PAELLA PAN WITH COMPARTMENTS

- Pan is divided into compartments to allow simultaneous preparation of different dishes.

code	mm
622759	ø430x(H)47
622766	ø430x(H)47



622759



622766



622841



622858



622704



622728



622742

ENAMELLED PAELLA BOWLS

- Deep model.
- Enamelled sheet steel.

code	mm
622810	ø145x(H)40
622827	ø170x(H)40
622834	ø185x(H)43
622841	ø205x(H)57
622858	ø245x(H)70

ENAMELLED PAN

- With two convenient handles.
- Made of enamelled steel.

code	mm
622704	ø100x(H)20
622711	ø120x(H)25
622728	ø150x(H)27
622735	ø200x(H)36
622742	ø240x(H)40



LIONHEAD

- Special, toughest porcelain type available on the market
- High-impact and wear resistance and still relatively light-weight
- Shining white



784730

784778

784754

SOUP BOWL

code	order unit	liters	mm
784747	12	1	ø175x(H)120
784730	8	2	ø215x(H)155

SOUP BOWL

code	order unit	liters	mm
784778	6	0.125	ø90x(H)60
784761	4	0.25	ø120x(H)78
784754	4	0.5	ø138x(H)95



783153

783160

783177

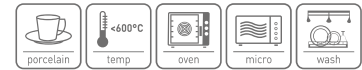

RAMEKIN

- Ribbed, made of porcelain.

code	order unit	mm
783153	12	ø70x(H)35
783160	6	ø90x(H)48
783627	6	ø100x(H)25
783177	6	ø120x(H)55



PLATE BARK

- Rectangular.

code	order unit	mm
785546	6	218x105x(H)23
785553	4	352x146x(H)40



BOWL VANILLA

code	order unit	mm
785560	6	225x111x(H)62
785577	4	290x136x(H)80



SOUP AND SAUCE BOWLS



434208

SOUP TUREEN

- With lid and serving spoon

code	liters	mm
434208	2.7	ø270x(H)175



432136

SAUCE BOAT

- On foot.

code	liters	mm
432143	0.085	120x72x(H)50
432006	0.14	135x76x(H)70
432105	0.23	160x98x(H)90
432129	0.28	200x100x(H)105
432136	0.46	240x120x(H)120



430002

SOUP BOWL

- With handles.

code	liters	mm
430002	0.35	ø120x(H)50



401200

VEGETABLE DISH

- With handles.

code	mm
401200	ø160x(H)40
401002	ø120x(H)30
401101	ø140x(H)35



400203



SERVING DISH

code	mm
400203	205x155



441107



ICE-CREAM CUP

- On foot.

code	mm
441107	ø90x(H)50



OVEN DISHES WHITE PORCELAIN

- Special porcelain type, toughest type available.
- Thermal shock resistant, can withstand extreme temperature changes.
- High-impact and wear resistance and still relatively light-weight.
- Extremely pure and brilliant white.



TAPAS DISH OVAL

- With handles.



code	order unit	mm
784006	6	200x107x(H)30
784013	6	262x140x(H)33
784020	3	324x185x(H)38



TAPAS DISH RECTANGULAR

- With handles.



code	order unit	mm
784105	6	160x101x(H)45
784112	4	236x126x(H)48
784129	3	328x189x(H)58



786352

RUSTICA OVEN DISH SQUARE

code	order unit	mm
786352	1	165x165x(H)65



786321

RUSTICA OVEN DISH OVAL

code	order unit	mm
786321	1	223x132x(H)42
786338	1	245x145x(H)55



786369

RUSTICA OVEN DISH RECTANGULAR

code	order unit	mm
786369	1	282x192x(H)65
786376	8	335x232x(H)62
786383	4	380x260x(H)70



786307

RUSTICA OVEN DISH ROUND

code	order unit	mm
786307	4	ø100x(H)50



CHILDREN



786499

CHILDREN'S PLATE „BEAR”

- Ø 190 mm without ears.

code	order unit	mm
786499	4	ø265



786239

ICE CREAM BOWL CLOWN

code	order unit	mm
786239	6	226x145x(H)37



786413



CONDIMENT SET

- 2-piece set: salt, pepper.

code	order unit	mm
786413	3	ø42x(H)80



786420



CONDIMENT SET

- 3 piece set: salt, pepper, toothpick holder.

code	order unit	mm
786420	48	125x54x(H)90



GRAVY BOAT

code	order unit	mm
786437	4	180x55x(H)130



786437



OVEN DISHES CREAM PORCELAIN

- Special porcelain type, toughest type available.
- Thermal shock resistant, can withstand extreme temperature changes.
- High-impact and wear resistance and still relatively light-weight.
- Cream white.

OVEN DISH ROUND

code	order unit	mm
785904	6	185x152x(H)40



785904



TAPASMINI

- Special, toughest porcelain type available on the market.
- High-impact and wear resistance and still relatively light-weight.
- Shining white.



784426



784327



784365

TAPAS DISH PLATO - 6 PCS

code	packed per	mm
784426	6	ø100x(H)25

TAPAS DISH CUADRADO - 6 PCS

code	packed per	mm
784327	6	80x80x(H)35

TAPAS DISH REDONDO - 6 PCS

code	packed per	mm
784365	6	ø75x(H)30



784433



784334

TAPAS DISH LEON - 6 PCS

code	packed per	mm
784433	6	ø55x(H)45

TAPAS DISH CONCHA - 6 PCS

code	packed per	mm
784334	6	90x50x(H)20



784419



784396

TAPAS DISH CUADRADO - 6 PCS

code	packed per	mm
784419	6	59x59x(H)37

TAPAS DISH TRIANGOLO - 6 PCS

code	packed per	mm
784396	6	100x100x(H)25



784389



784372



785324

TAPAS DISH CACEROLE - 6 PCS

code	packed per	mm
784389	6	ø60x(H)25

TAPAS DISH HUEVO - 6 PCS

code	packed per	mm
784372	6	ø65x(H)15

TAPAS DISH CUCHARA - 6 PCS

code	packed per	mm
785324	6	130x43x(H)26



PRESENTATION MINIATURES



564509



MINI SAUCEPAN LITTLE CHEF

- Melamine presentation bowls and trays, shaped like cookware.

code	mm
564509	162x121x(H)30

564516



MINI GRIDDLE PAN LITTLE CHEF

- Melamine presentation bowls and trays, shaped like cookware.

code	mm
564516	320x162x(H)20

564523



MINI ROUND PAN LITTLE CHEF

- Melamine presentation bowls and trays, shaped like cookware.

code	mm
564523	150x115x(H)37
564530	189x147x(H)37

564554



MINI OVAL PAN LITTLE CHEF

- Melamine presentation bowls and trays, shaped like cookware.

code	mm
564547	155x80x(H)37
564554	263x140x(H)37





678206



678169

GREASEPROOF PAPER - 500 PCS

- Packed per 500 sheets.

code	-	mm
678237	neutral	250x200
678220	chef food pattern	250x200
678213	neutral	263x380
678183	neutral	306x305
678169	chef food pattern	306x305
678176	checked pattern	306x305
678206	kitchen mayhem	258x425

GREASEPROOF PAPER PLACEMAT - 500 PCS

- Packed per 500 sheets.

code	-	mm
678145	kitchen mayhem	420x275
678152	checked pattern	420x275



678190

GREASEPROOF PAPER LINING PRE-SHAPED - 150 PCS

- Pre-shaped in a basket form.
- With illustration of a chef with food in a pattern.
- Packed per 150 pieces.

code	mm
678190	160x160x(H)50

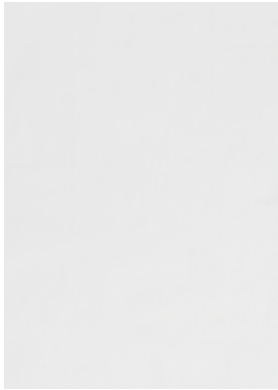

678237

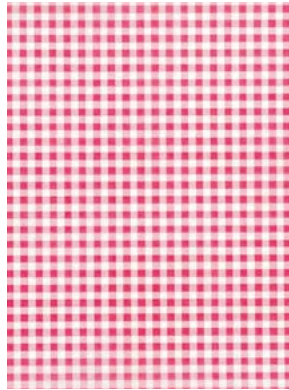

678152



678121

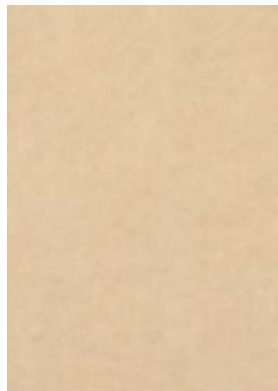

678138

GREASEPROOF PAPER - 500 PCS

- Packed per 500 sheets.

code	colour	mm
678138	Beige	200x250
678114	Beige	250x350
678121	Newspaper print	200x250
678107	Newspaper print	250x350



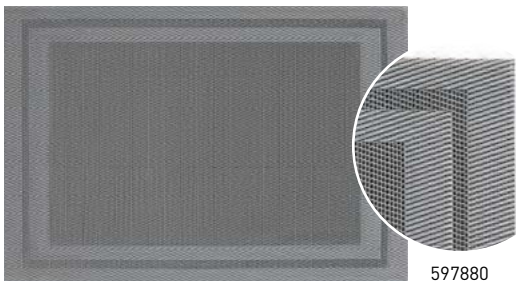

597880

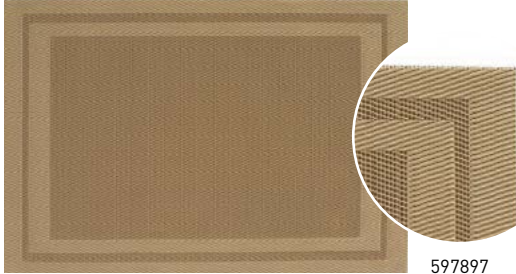

597897



597910

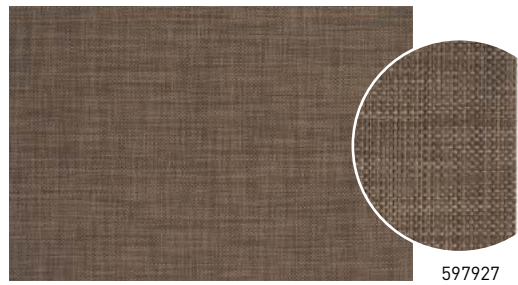

597927



597934



597941



NEW

PLACEMAT - SET

- Made from PVC (vinyl), in a woven pattern.
- Non-slip thanks to the material structure.
- Flexible, they don't deform after rolling up.

code	colour	mm
597880	Graphite	450x300
597897	Beige	450x300
597910	Light grey	450x300
597927	Brown	450x300
597934	Green	450x300
597941	Silver	450x300



PRESENTATION MINIATURES



426425

426432

426449

426456

DEEP FRYING BASKET MINIATURES

code	mm
426449	90x90x(H)90
426425	100x80x(H)75
426432	125x100x(H)85
426456	255x135x(H)45



425619

425626

425633

425657



DEEP FRYING BASKET MINIATURES

- Finished with a matt black coating.

code	mm
425633	90x90x(H)90
425619	100x80x(H)75
425626	125x100x(H)85
425657	255x135x(H)45

PORCELAIN, CUTLERY, TABLEWARE



630907



426494

CHIPS BAG HOLDER

code	mm	code	mm
630907	ø110x(H)175	426494	ø115x(H)100

CHIPS BASKET

- Finished with a matt black powder coating.



DEEP FRYING BASKET MINIATURES STACKABLE

code	mm
425664	105x90x(H)60
425688	130x115x(H)80



425664



425688



DEEP FRYING BASKET MINIATURES STACKABLE BLACK

- Finished with a matt black coating.

code	mm
425671	105x90x(H)60
425695	130x115x(H)80



425671



425695



630938

CHIPS BAG HOLDER

- Black wire frame, fits 1 chip bag.

code	mm
630938	ø115x(H)172



630914

CHIPS BAG HOLDER

- Black wire frame, with room for a sauce bowl.
- Melamine ramekin 80 ml fits perfectly (561713), not included.

code	mm
630914	210x110x(H)172



630921

CHIPS SERVING STAND FOR 3 BAGS

- Finished in matte black.
- For 3 bags.

code	mm
630921	270x270x(H)280





426357



426463

BUCKET MINIATURES

code	mm
426364	ø87x(H)93
426371	ø125x(H)127

SNACK CAN

code	mm
426463	ø45x(H)50
426470	ø70x(H)100



607015

607022

607039



SMALL SAUCE PAN WITH SPOUT

- Made of 2.5 mm thick 3-ply material, copper/aluminium/stainless steel.
- Handle attached by rivets.

code	mm
607015	ø50x(H)30
607022	ø75x(H)40
607039	ø85x(H)50



607046

SMALL FRYING PAN

- Made of 2.5 mm thick 3-ply material, copper/aluminium/stainless steel.
- Handle attached by rivets.

code	mm
607046	ø120x(H)30





426487

SNACK PAN

code	mm
426487	185x95x(H)45



PAN SERIES COPPER

- 2,5 mm thick 3-ply construction consists of stainless steel (0,4 mm), aluminium (1,5 mm) and copper (0,4 mm).
- Handles are attached by rivets.



607060

FRYING PAN

code	thickness (mm)	mm
607060	2.5	ø240x(H)50



607053

SAUCEPAN - WITHOUT LID

code	liters	mm
607053	1.5	ø160x(H)80



GALVANIZED BUCKETS

- Made of galvanized sheet steel, this creates a rustic look.
- Galvanized steel isn't intended for food contact, line the buckets with our greaseproof paper sheets when using it for serving food.



DOUBLE BUCKET WITH HANDLE

- Handle is made of wood.

code	mm
425947	190x95x(H)90
425954	250x125x(H)105



TABLE CADDY

- With wooden grip handle.

code	mm
425978	245x180x(H)130



PARTY TUB

code	mm
425992	400x330x(H)220



BUCKETS WITH HANDLE

code	mm
425909	ø70x(H)65
425916	ø100x(H)90
425923	ø120x(H)105
425985	ø160x(H)140





RAMEKIN

- Ribbed, made of porcelain.

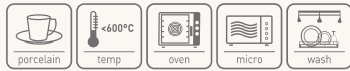

code	order unit	mm
783153	12	ø70x(H)35
783160	6	ø90x(H)48
783627	6	ø100x(H)25
783177	6	ø120x(H)55



RAMEKIN - Ribbed.



code	-	packed per	mm
561492	35 ml	1	ø60x(H)25
565643	35 ml	4	ø60x(H)25 NEW
561706	50 ml	1	ø70x(H)35
565650	50 ml	4	ø70x(H)35 NEW
561713	80 ml	1	ø80x(H)40
561720	100 ml	1	ø85x(H)45



RAMEKIN - 12 PCS



code	colour	liters	mm
565605	Black	0.045	ø60x(H)35
565612	Ivory	0.045	ø60x(H)35



VELOCITY SLANTED BOWLS



code	mm
564578	70x70x(H)60
564585	97x97x(H)80
564592	110x110x(H)100



RAMEKIN - 12 PCS

code	packed per	liters	mm
400029	12	0.07	ø62x(H)40
400012	12	0.045	ø62x(H)24
400036	12	0.115	ø73x(H)47
400043	12	0.175	ø85x(H)52
400050	12	0.23	ø93x(H)58
400067	12	0.34	ø100x(H)75



BUTTER & SAUCE DISH - 3 PCS

code	packed per	colour	mm
564561	3	Black	ø80x(H)30



564561



BAKERY BASKET OVAL



code	colour	mm
426777	Black	190x120x(H)60
426760	Light grey	190x120x(H)60
426623	Black	250x190x(H)65
426616	Light grey	250x190x(H)65
426654	Black	320x230x(H)70
426647	Light grey	320x230x(H)70



BAKERY BASKET

code	colour	mm
426784	Light grey	190x130x(H)60
426791	Black	190x130x(H)60



BASKETS WITH WOVEN SIDES

code	-	mm
426258	round	200x200x(H)65
426234	oval	225x130x(H)55
426265	oval	320x230x(H)55
426227	square	190x190x(H)80
426241	rectangular	225x150x(H)65



BAKERY BASKET WITH BAG

- Finished with a matt black powder coating.
- Fitted with a grey, washable bag.

code	-	mm
427118	round	220x220x(H)80
427125	oval	250x160x(H)75
427149	square	190x190x(H)100
427132	rectangular	250x180x(H)85





426067



426074



426043



426050

CUTLERY BASKET

- With 4 compartments.



code	colour	mm
426074	Black	260x180x(H)150
426067	Light grey	260x180x(H)150

SNACK BASKET



code	colour	mm
426050	Black	ø130x(H)110
426043	Light grey	ø130x(H)110



426081

426098



CUTLERY BASKET

code	colour	mm
426098	Black	270x100x(H)45
426081	Light grey	270x100x(H)45



426197

426210



CUTLERY BASKET

code	colour	mm
426210	Black	ø100x(H)120
426197	Light grey	ø100x(H)120



SERVING BASKETS FAST FOOD STYLE

- Ideal for fast food restaurant, diners and street food vendors.

- Set of 6 polypropylene serving baskets.

- Light weight, stackable and easy to clean.

- Available in multiple colours.

code	colour	mm
426296	brown	275x175x(H)38
426319	red	275x175x(H)38
426890	black	275x175x(H)38



426319

426296

426890



BASKETS

- Polyrattan.



BREAD BASKET - OVAL

code	mm
426500	225x130x(H)55

BREAD BASKET - RECTANGULAR

code	mm
426807	225x150x(H)65

BREAD BASKET - ROUND

code	mm
426609	ø200x(H)65

BREAD BASKET - OVAL

code	mm
426708	225x110x(H)60

BREAD BASKET - OVAL

code	mm
426906	375x140x(H)70



PITTA BREAD BASKET - ROUND

code	mm
425701	ø150x(H)38
425800	ø200x(H)50



PITTA BREAD BASKET - OVAL

code	mm
425503	195x140
425602	255x190



WIRE BASKETS



425831

BASIC WIRE BASKET, OVAL

- Finished in matte black.

code	mm
425831	230x180x(H)60



425817

425824

WIRE BASKET BASIC ROUND

- Finished in matte black.

code	mm
425817	ø100x(H)90
425824	ø120x(H)110



425855

WIRE BASKET DECO RECTANGULAR

- With decorative rim.

- Finished with a matt black coating.

code	mm
425855	230x150x(H)80



425862

WIRE BASKET DECO ROUND

- With decorative rim.

- Finished with a matt black coating.

code	mm
425862	ø250x(H)80



425879

WIRE BASKET DECO OVAL

- With decorative rim.

- Finished with a matt black coating.

code	mm
425879	255x160x(H)80



425886

WIRE BASKET DECO OBLONG

- With decorative rim.

- Finished with a matt black coating.

code	mm
425886	385x160x(H)80

425565



425534



SERVING BASKET

code	mm
425565	310x125x(H)55
425534	290x220x(H)60

425558



425572

SERVING BASKET BLACK

- Finished in matte black.

code	mm
425572	310x125x(H)55
425558	295x220x(H)60

BREAD BAGS



429006

429051

429037

429228

429211

BREAD BAG, ROUND

- Made of durable cotton.
- Available in gray/beige and gray/dark blue color combinations.

code	colour	mm
429006	Beige	ø150x(H)150
429013	Dark grey	ø150x(H)150
429020	Beige	ø200x(H)200
429037	Dark grey	ø200x(H)200
429044	Beige	ø250x(H)160
429051	Dark grey	ø250x(H)160

PAPER BREAD BAGS

- Made of food grade washable kraft paper.

code	colour	mm
429228	Beige	170x170x(H)150
429211	Black	170x170x(H)150



426418

FRUIT BASKET

- Chrome-plated wire.



code	mm
426418	ø215x(H)205



427187

FRUIT BASKET BLACK

- Finished with a matt black powder coating.



code	mm
427187	ø230x(H)250



FRUIT BASKET ANGLED ROUND BLACK

- Finished with a matt black powder coating.

code	mm
427095	ø150x(H)80
427088	ø280x(H)130
427071	ø300x(H)250



427088



427095



427071





VACUUM JUG

- Tight sealing lid with push button for pouring.
- Double walled with glass inner bottle.

code	liters	mm
449615	1	ø110x(H)289

449615





448908

AIR POT

- Stainless steel mantle.
- With press system to tap drinks.
- Inside made from stainless steel.

code	liters	mm
448908	2.2	ø150x(H)340



445877

AIR POT - 3L

- Double wall vacuum body and PP head.
- Rotatable on base.
- Zinc alloy lever designed for extra strength.
- Lid opens to 125 degrees for brewing and is also detachable for cleaning.
- Secure carrying handle.

code	mm
445877	(H)373



VACUUM JUG WITH GLASS INNER BOTTLE

code	liters	mm
449608	1	ø140x(H)268



449608



VACUUM JUG

- Double walled stainless steel.
- Seamless structure.
- Vacuum insulation.
- Metal chromed cover, lever, spout and handle.
- High insulation value.

18/10
stainless steel

VACUUM JUG

code	liters	mm
445815	0.6	ø120x(H)168
445822	1	ø136x(H)188
445839	1.5	ø136x(H)258



445815

445822

445839



VACUUM JUG

- Double walled stainless steel.
- With black push-button cap.
- Top and lid made of polypropylene.

code	liters	mm
446607	1.5	ø145x(H)230
446508	1	ø145x(H)205
446706	2	ø145x(H)260



446508

446607

446706



VACUUM JUG

- Double walled stainless steel.
- With yellow push-button cap.
- Top and lid made of polypropylene.

code	liters	mm
446522	1	ø145x(H)205
446621	1.5	ø145x(H)230
446720	2	ø145x(H)260



446522

446621

446720





453001

453209

453407

COFFEE/ TEA POT WITH LID

- With hinged lid.
- Straight model.

code	liters	mm
453001	0.2	ø74x(H)95
453100	0.3	ø74x(H)123
453209	0.6	ø97x(H)142
453308	0.9	ø120x(H)158
453407	1.4	ø126x(H)185



451502

451519

451526

451533

MULTIPURPOSE JUGS

code	liters	mm
451502	0.35	ø76x(H)93
451519	0.6	ø90x(H)112
451526	0.9	ø102x(H)125
451533	1.5	ø112x(H)161



451038

451021

451014

MILK JUG

- Made of extra thick stainless steel, helps keep the content hot.
- V-shaped spout gives extra control during pouring.

code	liters	mm
451038	0.35	ø65x(H)99
451021	0.45	ø75x(H)111
451014	0.7	ø84x(H)130



451007

451106

MILK JUG

- Simple design.

code	liters	mm
451007	0.35	ø85x(H)110
451106	0.75	ø100x(H)120





CREAM JUG

- Made of stainless steel.
- Shape with an easy-pour spout designed for clean and efficient work.
- Dishwasher safe.

code	liters	mm
450109	0.03	ø35x(H)35
450208	0.04	ø40x(H)40
450307	0.07	ø50x(H)55
450406	0.12	ø60x(H)60
450505	0.25	ø75x(H)75



458198

MILK JUG BLACK

- Made from stainless steel with a black non-stick coating.

code	liters	mm
458198	0.6	ø90x(H)112



451045

MILK JUG – MATT BLACK

- Made of extra thick stainless steel, helps keep the content hot.
- V-shaped spout gives extra control during pouring.

code	liters	mm
451045	0.7	ø84x(H)130



SALT GRINDERS & PEPPER MILLS

NEW



P - pepper



Stainless steel pepper grinding mechanism



S - salt



Ceramic salt grinding mechanism



469613

469606

469590

469583

469576

469569

469552

469545



469682
469699

469705
469712

469729
469736

469743
469750

469767
469774

469781
469798

469804
469811

469828
469835



WOODEN PEPPER MILL

- Body made of rubber wood - lightweight, but durable.
- Grinding mechanism (burrs) made of stainless steel, manual and adjustable with a knob.
- Lid protected from falling off with a screwed knob.
- Knob with a printed "P" letter - for marking pepper.

code	-	mm
469576	black	ø50x(H)113
469569	black	ø55x(H)215
469552	black	ø60x(H)315
469545	black	ø65x(H)415
469682	light wood	ø50x(H)113
469705	light wood	ø57x(H)165
469729	light wood	ø57x(H)215
469743	light wood	ø60x(H)315
469767	dark wood	ø50x(H)113
469781	dark wood	ø57x(H)165
469804	dark wood	ø57x(H)215
469828	dark wood	ø60x(H)315

WOODEN SALT GRINDER

- Body made of rubber wood - lightweight, but durable.
- Ceramic grinding mechanism (burrs) - non-corrosive (suitable for salt), manual and adjustable with a knob.
- Lid protected from falling off with a screwed knob.
- Knob with a printed "S" letter - for marking salt.

code	-	mm
469613	white	ø50x(H)113
469606	white	ø55x(H)215
469590	white	ø60x(H)315
469583	white	ø65x(H)415
469699	light wood	ø50x(H)113
469712	light wood	ø57x(H)165
469736	light wood	ø57x(H)215
469750	light wood	ø60x(H)315
469774	dark wood	ø50x(H)113
469798	dark wood	ø57x(H)165
469811	dark wood	ø57x(H)215
469835	dark wood	ø60x(H)315

NEW



469620

469644

469668

ACRYLIC PEPPER MILL

- Body made of transparent acrylic glass (PMMA) - a lighter substitute for glass, but more resistant to scratching and breakage.
- Grinding mechanism (burrs) made of stainless steel, manual and adjustable with a knob.
- Lid protected from falling off with a screwed knob.
- Knob with a printed "P" letter - for marking pepper.

code	mm
469620	ø50x(H)113
469644	ø50x(H)140
469668	ø60x(H)215

NEW



469637

469651

469675

ACRYLIC SALT GRINDER

- Body made of transparent acrylic glass (PMMA) - a lighter substitute for glass, but more resistant to scratching and breakage.
- Ceramic grinding mechanism (burrs) - non-corrosive (suitable for salt), manual and adjustable with a knob.
- Lid protected from falling off with a screwed knob.
- Knob with a printed "S" letter - for marking salt.

code	mm
469637	ø50x(H)113
469651	ø50x(H)140
469675	ø60x(H)215



18/0
stainless steel

452400

SUGAR DISPENSER

- Glass dispenser.
- Spout made of stainless steel 18/0.

code	mm
452400	ø80x(H)140



S.S.
stainless steel

452424

HONEY DISPENSER

- Glass dispenser.
- Stainless steel lever.

code	mm
452424	ø80x(H)115



18/0
stainless steel

465370

CHEESE/SUGAR DISH

- With glass dish.
- Including stainless steel spoon.

code	mm
465370	ø130x(H)90



631102

S.S.
stainless steel

631300

631201

SHAKER

code		mm
631102	parmesan shaker	ø55x(H)75
631201	pepper and salt shaker	ø55x(H)75
631300	wire mesh powder shaker	ø55x(H)75



786413

porcelain micro

CONDIMENT SET

- 2-piece set: salt, pepper.

code	order unit	mm
786413	3	ø42x(H)80



786420

porcelain micro

CONDIMENT SET

- 3 piece set: salt, pepper, toothpick holder.

code	order unit	mm
786420	48	125x54x(H)90



599327

18/8
stainless steel

FREE-FLOW POURER - 3 PIECES

- For use in bars, pubs and restaurants
- Durable stainless steel construction
- Counterbalanced pouring flap, which causes the nozzle to open and close automatically when the bottle is tilted
- Facilitates precise dispensing
- Suitable for standard 0.5 - 1.5 liter bottles with holes up to ø20 mm in diameter

code	packed per	mm
599327	3	ø30x120



S.S.
stainless steel

460245

OIL AND VINEGAR SET

- Holder made of chrome-plated iron.
- Two oil/vinegar bottles with stainless steel pourers.

code		mm
460245	2x0,237L	115x60x(H)325



465301

CONDIMENT SET

- 2-piece - salt, pepper.
- Matt finish.

code	mm
465301	85x55x(H)115

18/0
stainless steel



465349

CONDIMENT SET

- 2-piece - oil, vinegar.
- Matt finish.

code	liters	mm
465349	0.15	120x75x(H)185

18/0
stainless steel



465332

CONDIMENT SET

- 3-piece - salt, pepper, mustard.
- With stainless steel mustard spoon.
- Matt finish.

code	mm
465332	100x95x(H)115

18/0
stainless steel



465318

CONDIMENT SET

- 3-piece - salt, pepper, napkin holder.
- Matt finish.

code	mm
465318	85x75x(H)115

18/0
stainless steel



465325

CONDIMENT SET

- 3-piece - salt, pepper, toothpick holder.
- Matt finish.

code	mm
465325	90x90x(H)115

18/0
stainless steel



465356

CONDIMENT SET

- 4-piece - salt, pepper, oil, vinegar.
- Matt finish.

code	mm
465356	130x110x(H)185

18/0
stainless steel



465363

CONDIMENT SET

- 5-piece - salt, pepper, oil, vinegar, toothpick holder.
- Matt finish.

code	mm
465363	130x110x(H)185

18/0
stainless steel



465387

SALT AND PEPPER SHAKER SET

- Glass shaker.
- Stainless steel lid with S and P shaped dispensing opening.

code	mm
465387	ø40x(H)70

S.S.
stainless steel



461167

461266

PEPPER SHAKER

- Body made of glass.
- Stainless steel lid with P-shaped dispensing opening.

code	packed per	mm
461167	6	ø40x(H)70

S.S.
stainless steel

SALT SHAKER

- Body made of glass.
- Stainless steel lid with S-shaped dispensing opening.

code	packed per	mm
461266	6	ø40x(H)70



664186

CUTLERY BOX

- Made from durable wood.

code	mm
664186	80x80x(H)95



427033

CUTLERY BASKET BLACK

- Finished with a matt black powder coating.

code	mm
427033	ø120x(H)150



664315

TABLE CADDY

- Made from durable wood.

- Has two compartments and a large handle.

code	mm
664315	190x160x(H)200



425770

CONDIMENT RACK RECTANGULAR

- Finished with a matt black powder coating.

code	mm
425770	205x90x(H)180



425787

CONDIMENT RACK ROUND

- Finished with a matt black powder coating.

code	mm
425787	ø165x(H)205



664148

MENU AND CUTLERY BOX

- Wooden box with integrated blackboard on two sides.

- Box has 4 compartments.

code	mm
664148	210x150x(H)150



427170

CONDIMENT RACK BLACK

- Finished with a matt black powder coating.

code	mm
427170	135x65x(H)200



427064

TABLE CADDY BLACK

- Fitted with a wooden handle.

- Finished with a matt black powder coating.

code	mm
427064	140x105x(H)190
427057	170x130x(H)160
427040	230x100x(H)240



427040



427057



456514

TEA BOX

- Box made of wood in a natural light shade.
- Lid: a wooden frame with an acrylic window, on hinges, opened upwards.
- 12 compartments in the box, each can store 12 tea bags.



code	mm
456514	300x280x(H)90



570807

TEA STRAINER - WITH HINGED HANDLE

- For herbs and tea.
- With hinged handle.



code	mm
570807	ø40x150



638101

TEA & HERB STRAINER

- For herbs and tea.
- With wire handle.



code	mm
638101	ø70x225



523629

SUGAR CUBE TONGS - 2 PCS



code	packed per	mm
523629	2	(L)160



452325

452714

SUGAR/WHIPPED CREAM DISH



code	packed per	mm
452714	6	ø65x(H)20
452325	4	ø100x(H)20



452103

SUGAR BOWL

- With hinged lid.



code	liters	mm
452103	0.3	ø85x(H)80



452202

SUGAR BOWL

- Without lid.



code	liters	mm
452202	0.3	ø85x(H)65



595008

RECEPTION BELL

- Chrome-plated with metal base.



code	mm
595008	ø85x(H)57



444023

TABLECLOTH CLIP - 4 PCS



code	packed per	mm
444023	4	50x10x(H)40

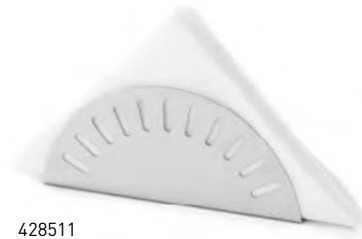

428511

NAPKIN HOLDER

- Matt finish.



code	mm
428511	170x30x(H)70



428528

NAPKIN HOLDER

- Chrome-plated wire.



code	mm
428528	190x190x(H)65



427163

NAPKIN HOLDER BLACK

- Finished with a matt black powder coating.

code	mm
427156	155x160
427163	205x210



441503

EGG SPOON - 6 PCS

- White.

- ABS



code	packed per
441503	6



441466

EGG CUP - 6 PCS

- Low model.



code	packed per	mm
441466	6	ø85x(H)15



441367

EGG CUP - 6 PCS

- On foot.



code	packed per	mm
441367	6	ø50x(H)45



440704



TABLETOP LITTERBIN

- Stainless steel container
- Black ABS tumble cover

code	mm
440704	ø120x(H)165



440711



TABLETOP LITTERBIN

- With plastic top and stainless steel swing cover.

code	mm
440711	ø95x(H)130



421574



TABLETOP LITTERBIN OR CUTLERY HOLDER

- Black container made of melamine

code	colour	mm
421574	Black	ø130x(H)160



can be used as a cutlery holder



513729

RECEIPT HOLDER

code	mm
513729	ø80x(H)150



595206



RECEIPT HOLDER - 3 PCS

- With clamp.



code	packed per	mm
595206	3	152x110



665251



MENU CARD TABLE STAND - 6 PCS

- Supplied without menu card.

code	packed per	mm
665251	6	80x77x(H)18



665510

MENU CARD TABLE STAND

code	mm
665503	ø75x(H)100
665510	ø75x(H)200



595305

MENU CARD HOLDER - 2 PCS

- With clamp.

code	packed per	mm
595305	2	ø40x(H)104





664179

664162

664155



MENU CLIPBOARD

- Made from durable MDF with metal clamping mechanism.
- Available in multiple sizes.

code	mm
664179	125x180
664162	185x245
664155	240x330



663608



663615



663622



663639



663646



663653

DOOR SIGNS

- With self-adhesive strip.



code	-	mm
663608	men	ø75
663615	women	ø75
663622	toilets	ø75
663639	no smoking	ø75
663646	wheelchair	ø75
663653	mobile off	ø75



663820



663806

DOOR SIGN

- Self-adhesive.



code	-	mm
663790	no smoking	ø75
663820	smoking - big	ø160
663806	no smoking - big	ø160

663660



TABLE SIGN ,NO SMOKING'

- 2 sides printed.



code	mm
663660	50x35x(H)40

TABLE SIGNS NUMBERED

- Made from durable wood.
- Set numbered from 1 to 10.



code	-	mm
664322	Numbers 1-10	55x48x(H)44



664322

TABLE SIGN RESERVED

- Made from durable wood.
- With slot to hold a menu.



code	-	mm
664308	„reserved“	152x44x(H)44



664308



TABLE SIGN RESERVED - 4 PCS



code	-	packed per	mm
663691	Gerreserveerd / Reservé	4	50x35x(H)40
663707	Reserviert	4	50x35x(H)40



663691

TABLE SIGN RESERVED

- Black - white.
- Printed on 2 sides.



code	-	mm
663486	réservé	130x30x(H)38
663462	reserved	130x30x(H)38
663745	gereserveerd	130x30x(H)38
663479	reserviert	130x30x(H)38

663745



663462

TABLESTAND NUMBERS

- Sets of multiple numbers 12 numbers per set.



code	-	mm
663844	Numbers 1-12	50x35x(H)40
663851	Numbers 13-24	50x35x(H)40
663868	Numbers 25-36	50x35x(H)40
663875	Numbers 37-48	50x35x(H)40
663882	Numbers 49-60	50x35x(H)40
663899	Numbers 61-72	50x35x(H)40



663844

BLACKBOARDS



664025



664032



664049



664018

664001

WALL BLACKBOARD

- Black, with wooden frame.
- Mounting hooks included.

code	mm
664025	300x400
664032	400x600
664049	600x800

PAVEMENT BLACKBOARD

- Black, with wooden frame.

code	mm
664001	500x450x(H)850
664018	700x600x(H)1200



664100



664117

PAVEMENT BLACKBOARD

- Black, with steel frame.

code	mm
664100	700x500x(H)1100

PAVEMENT BLACKBOARD

- Black, with steel frame.

code	mm
664117	500x550x(H)850





TABLETOP BLACKBOARD - 2 PCS
- Black, with wooden standard.

code	packed per	mm
664087	2	148x130x(H)120
664094	2	210x190x(H)150



TABLETOP BLACKBOARD - 2 PCS
- Black, with wooden stand.

code	packed per	mm
664056	2	150x50x(H)230
664063	2	210x50x(H)320

664124



BLACKBOARD WITH STAND
- Large format blackboard in wooden frame.
- Convenient stand included.

code	mm
664124	300x400
664131	400x600

664070



BLACKBOARD WITH EASEL
- Black, with wooden easel.

code	mm
664070	220x210x(H)360



664278

BLACKBOARD MARKERS 3 MM
- 8 Markers with round nib, writing width 3 mm.

code	
664278	1 white, 1 red, 1 blue, 1 green, 1 yellow, 1 purple, 1 orange and 1 pink marker



664209

664216

BLACKBOARD MARKERS WITH NARROW TIP
- With oblique nib, writing width 2 to 6 mm.

code	
664292	2 white, 1 pink, 1 yellow and 1 bronze markers
664216	1 pink, 1 green, 1 blue and 2 white markers
664209	5 white markers



664339

664223

BLACKBOARD MARKERS 15 MM
- With wide flat nib, writing width 15 mm.

code	
664339	1 white, 1 orange and 1 yellow marker
664223	3 white markers



664285

BLACKBOARD MARKERS 1 MM
- 6 Markers with round nib, writing width 1 mm.

code	
664285	3 white, 1 pink, 1 yellow and 1 bronze markers

ASHTRAYS & ASH COLLECTOR

440605



ASHTRAY WITH LOWER TRAY

code	mm
440605	ø140x(H)40

569757



ASHTRAY

- Made of black melamine.

code	mm
569757	ø146x(H)60

440407



ASHTRAY WITH LID - 3 PCS

code	packed per	mm
440407	1	ø90x(H)28
440490	3	ø90x(H)28

440803



ASHTRAY

code	mm
440803	ø80x(H)30
440858	ø100x(H)30
440902	ø120x(H)30

440001



ASHTRAY WITH FIRE RIM

code	mm
440001	ø140x(H)30
440100	ø160x(H)30

440872



ASHTRAY

code	mm
440872	ø80x(H)30
440865	ø100x(H)30

440230



BOWL ASHTRAY BLACK

- Stainless steel, outside with a matt black coating.
- With removable rim.

code	mm
440230	ø105x(H)58

ASH COLLECTOR

- With hinged lid.
- For safe emptying of ashtrays.
- Self-extinguishing.

code	mm
440506	202x170x(H)91



440209



ASHTRAY WITH PUSH BUTTON

code	mm
440209	ø90x(H)45



440506





440216

WALL MOUNTED ASHTRAY

- Very robust design, easy to mount against walls and poles.
- Easy to empty thanks to the bottom that can be opened and closed with a key.

code	mm
440216	ø75x(H)460



440223

STANDING ASHTRAY POLE

- Very robust design, can be mounted on the floor or stand free.
- Easy to empty, upper part can be unlocked with a key and then emptied.
- Base is Ø 170 mm, pole is Ø 75 mm.

code	mm
440223	ø170x(H)920

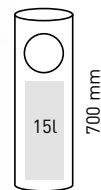

ø200 mm

691380



STANDING WASTE BIN WITH ASHTRAY

- Stainless steel body.
- Polished surface finish.
- Removable ashtray placed over the bin for easy cleaning and emptying of the bin.
- Bin opening Ø 135 mm.
- Anti-slip, rubber bottom to enhance bin stability and protect the floor against scratching.

code	liters	mm
691380	15	ø200x(H)700

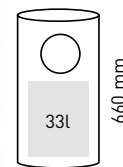

ø240 mm

691397



STANDING WASTE BIN WITH ASHTRAY

- Stainless steel body.
- Polished outer surface.
- Removable ashtray with a grid, placed over the bin for easy cleaning and emptying of the bin.
- Bin opening Ø 135 mm.
- Anti-slip, rubber bottom to enhance bin stability and protect the floor against scratching.

code	liters	mm
691397	33	ø240x(H)660





design by
Robert Bronwasser



NEW



470411



UNIQ CHAFING DISH

- Stylish and functional design by Dutch designer Robert Bronwasser.
- Body made from high temperature resistant polypropylene.
- Removable GN1/1 container (H)100 mm made of AISI 304 stainless steel, easy to clean.
- Heating element made from AISI 304 stainless steel and placed in the water container for efficient heat transfer.
- Tempered glass lid fitted with insulated handle, ladle notch and aluminium hinge.
- The design of the two-part lid reduces the heat loss by opening, while maintaining optimal hygienic conditions.
- Integrated card holder on the lid for product name cards.
- Sloping edge design of the lid that guides condensation water back into the container.
- The sensitive water sensor module reminds users when it's time to refill the water container and thus prevents dry boiling.
- Digital control panel with display to show working time, set temperature and actual temperature.
- The last temperature setting is saved in memory and will be selected every time the power is turned on.
- Temperature can be set from 35 up to 85°C in 1° increments.
- Water container is embossed with a max. fill line, indicating ±4 L.
- Not intended for cooking, only for keeping warm.

Special design of the lid guides condensation back into the container



Display shows total operating time

code	colour	V	W	mm
470411	Black	230	700	607x402x(H)250
470428	White	230	700	607x402x(H)250
470435	Green	230	700	607x402x(H)250

BUFFET PRODUCTS



470435



470428



design by
Robert Bronwasser



NEW



860526

UNIQU SOUP KETTLE

- Stylish and functional design by Dutch designer Robert Bronwasser.
- Body made from high temperature resistant polypropylene.
- Removable 8 litre soup container made of AISI 304 stainless steel, easy to clean.
- Heating element made from AISI 304 stainless steel and placed in the water container for efficient heat transfer.
- Tempered glass lid fitted with insulated handle, ladle notch and aluminium hinge.
- The design of the two-part lid reduces the heat loss by opening, while maintaining optimal hygienic conditions.
- Integrated card holder on the lid for product name cards.
- Sloping edge design of the lid that guides condensation water back into the container.
- The sensitive water sensor module reminds users when it's time to refill the water container and thus prevents dry boiling.
- Digital control panel with display to show working time, set temperature and actual temperature.
- The last temperature setting is saved in memory and will be selected every time the power is turned on.
- Temperature can be set from 35 up to 85 °C in 1° increments.
- Water container is embossed with a max. fill line, indicating ±1.5 L.
- Not intended for cooking, only for keeping warm.

code	colour	V	W	mm
860526	Black	230	500	ø366x(H)325
860533	White	230	500	ø366x(H)325
860540	Green	230	500	ø366x(H)325

Integrated card holder



Special design of the lid guides condensation back into the container

Display shows total operating time



860540



860533



ELECTRIC SOUP KETTLES



Soup name card holder in lid

Lid with insulated handle and ladle recess

Digital touch panel with display that alternates between set and actual soup temperature

Thermostat adjustable from 65° to 95°C by 1° increments



Overheating protection – with alarm for low water level

860502

SOUP KETTLE

- Thermal insulation reduces energy consumption and keeps the external housing cool.
- Reduction of energy consumption by up to 30%.
- Digital control panel with display showing the set temperature and actual soup temperature alternately.
- Removable lid made of tough, transparent polycarbonate.
- Aluminium water pan for efficient heat transfer.
- Food pan made of 18/8 stainless steel.
- Housing of polypropylene.
- Ring allows safe and easy removal of food pan.
- Overheating protection – with low water level alarm.
- Soup name card holder in lid.

code	liters	V	W	mm
860502	8	230	450	ø370x(H)300

SOUP PAN FOR ELECTRIC SOUP KETTLE

- Soup pan for use with the HENDI soup kettle 860502.
- Made of stainless steel and therefore easy to clean.

code	mm
926574	ø280x(H)200



860083

KITCHEN LINE SOUP KETTLE, 8 L

- Body Made of stainless steel. (painted black).
- Lid and water pan Made of stainless steel.
- Heating power control.
- Suitable ladles: 527306, 529003, 540305.



code	liters	V	W	mm
860083	8	230	435	ø340x(H)360





204825

CHAFING DISH ELECTRIC TELLANO

- Gastronorm 1/1
- Water pan made of heat-resistant polypropylene.
- Continuous settings up to 85°C.
- On/off switch, pilot light.
- Very silent whilest heating.
- Including GN 1/1 food pan 65 mm deep.



code	liters	V	W	mm
204825	9	230	900	573x348x(H)284



204900

CHAFING DISH ELECTRIC POLLINA

- Gastronorm 1/1.
- Temperature adjustable up to 85°C.
- With lid stand.
- On/off switch with integrated indication light.
- Including Gastronorm 1/1 food pan 65 mm deep.
- Suitable for pans up to 100 mm deep.



code	liters	V	W	mm
204900	9	230	850	615x355x(H)280



204832

CHAFING DISH ELECTRIC TESINO

- Water pan made of heat-resistant polypropylene.
- Continuous settings up to 85°C.
- Very silent whilest heating.
- On/off switch, pilot light.
- Including 6,8 ltr food pan.



code	liters	V	W	mm
204832	6.8	230	500	ø405x(H)248





475904



18/0
stainless steel

CHAFING DISH GASTRONORM 1/1

- Model Economic.
- High-gloss polished lid and lid stand.
- Including chafing dish fuel holders and stainless steel food pan 65 mm deep.
- Suitable for food pans up to 65 mm deep.

code	packed per	liters	mm
472613	2	9	600x358x(H)295
475904	1	9	600x358x(H)295



475201

18/0
stainless steel

CHAFING DISH GASTRONORM 1/2

- Model Economic.
- High-gloss polished lid and lid stand.
- Including chafing dish fuel holder and stainless steel food pan 65 mm deep.
- Suitable for food pans up to 65 mm deep.

code	liters	mm
475201	4.5	385x295x(H)310



470619

S.S. 18/0
stainless steel stainless steel

CHAFING DISH - ROUND

- Glass lid.
- Including chafing dish fuel holder and stainless steel food pan.

code	liters	mm
470619	3.5	ø390x(H)270



472507

S.S.
stainless steel

SOUP CHAFING DISH

- Model Economic.
- Including chafing dish fuel holder and stainless steel soup pan with lid.

code	liters	mm
472507	8	ø370x(H)325



CHAFING DISH GASTRONORM 1/1

- Model Fiora.
- Stackable frame with high-gloss polished lid and lid stand.
- Including two chafing dish fuel holders and stainless steel food pan 65 mm deep.
- Suitable for Gastronorm pans of up to 100 mm deep.

code	liters	mm
471005	9	585x385x(H)315



471005



470190



FOOD PAN GN 1/1, WITH 2 COMPARTMENTS

- This GN food pan has 2 compartments of 3.75 liter each.

code	liters	mm
470190	7.5	530x325x(H)65



470909

470907

470930



BAIN-MARIE PAN

- Fits perfectly in HENDI Conversion for 2 bain maries pans 470930.
- Also suitable for: Thermosystem bain-maries (201107, 201206).
- Made of stainless steel.
- Lid fitted with a comfortable handle.

code	mm
470909	ø220x(H)190

CONVERSION FOR 2 BAIN-MARIE PANS

- Suitable for 2 HENDI Bain-marie pans 470909.
- Made of stainless steel.
- Fits all GN 1/1 types chafing dishes.

code	-	mm
470930	conversion	530x325x(H)30



471050



CHAFING DISH SET

- Consists of: Chafing Dish "Fiora" as in 471005.
- 2 additional GN 1/2 pans 65 mm deep and 3 additional GN 1/3 pans 65 mm deep.

code	mm
471050	585x385x(H)315



CHAFING DISHES PROFI LINE



- Ideal for buffets and catering.
- By using high-quality material and a beautiful finish, these chafing dishes give every presented dish a certain allure.
- The chafing dishes and accessories are entirely made from durable stainless steel.



470251

CHAFING DISH GN 1/1 SATIN FINISH

- The lid is fitted with a friction brake, it stays in the position in which it is left.
- The lid can be removed to ease cleaning.
- Supplied with removable water pan, GN 1/1 65 mm deep food pan and 2 chafing dish fuel can holders.

code	liters	mm
470251	9	570x430x(H)290



470275

CHAFING DISH GN 2/3 SATIN FINISH

- The lid is fitted with a friction brake, it stays in the position in which it is left.
- The lid can be removed to ease cleaning.
- Supplied with removable water pan, GN 2/3 65 mm deep food pan and chafing dish fuel can holder.

code	liters	mm
470275	6	395x430x(H)290



470268

CHAFING DISH GN 1/2 SATIN FINISH

- The lid is fitted with a friction brake, it stays in the position in which it is left.
- The lid can be removed to ease cleaning.
- Supplied with removable water pan, GN 1/2 65 mm deep food pan and chafing dish fuel can holder.

code	liters	mm
470268	4	365x370x(H)280



470282

CHAFING DISH ROUND SATIN FINISH

- The lid is fitted with a friction brake, it stays in the position in which it is left.
- The lid can be removed to ease cleaning.
- Supplied with removable round water pan, round 65 mm deep food pan and chafing dish fuel can holder.

code	liters	mm
470282	6	465x420x(H)320





470213

CHAFING DISH GN 1/1 MIRROR FINISH

- The lid is fitted with a friction brake, it stays in the position in which it is left.
- The lid can be removed to ease cleaning.
- Supplied with removable water pan, GN 1/1 65 mm deep food pan and 2 chafing dish fuel can holders.

code	liters	mm
470213	9	570x405x(H)320



470237

CHAFING DISH GN 2/3 MIRROR FINISH

- The lid is fitted with a friction brake, it stays in the position in which it is left.
- The lid can be removed to ease cleaning.
- Supplied with removable water pan, GN 2/3 65 mm deep food pan and chafing dish fuel can holder.

code	liters	mm
470237	6	395x405x(H)320



470220

CHAFING DISH GN 1/2 MIRROR FINISH

- The lid is fitted with a friction brake, it stays in the position in which it is left.
- The lid can be removed to ease cleaning.
- Supplied with removable water pan, GN 1/2 65 mm deep food pan and chafing dish fuel can holder.

code	liters	mm
470220	4	365x345x(H)345



470244

SOUP CHAFING DISH MIRROR FINISH

- The round soup container is placed in a large water pan which provides plenty of heat to easily keep the soup hot.
- Soup container fitted with two handles.
- The lid has a recess for the spoon.
- Supplied with removable water pan, round soup container and chafing dish fuel can holder.

code	liters	mm
470244	10	ø420x(H)380



470206



809709



470305



470312

18/0

stainless steel

ROLLTOP-CHAFING DISH GASTRONORM 1/1

- Model Rental-Top.
- Solid base with high-gloss polished roll top lid made of 18/0 stainless steel.
- Includes two chafing dish fuel holders and stainless steel food pan 65 mm deep.
- Bottom fitted with fastening bolts for electric heating element 809709.
- Suitable for Gastronorm pans up to 100 mm deep.

code	liters	mm
470206	9	590x340x(H)400

CHAFING DISH HEATER

- The heater features a single and stable power level output (it does not have a temperature regulating function).
- Not intended for cooking, only for keeping warm.
- Fits perfectly to the HENDI Chafing dish water pan (code: 809716).
- Also suitable for the HENDI Rolltop-Chafing dish GN 1/1 (code: 470206) and any other GN 1/1 chafing dishes if a water pan is fitted with bolts.

code	V	W	mm
809709	230	380	300x200x(H)19

S.S.
stainless steel

ROLLTOP-CHAFING DISH GASTRONORM 1/1

- Elegant buffet chafing dish.
- Patented extra quiet opening mechanism.
- Roll-top cover retractable up to 180°.
- Optional installation of electrical heating element.
- Highly polished stainless steel.
- Steel frame 2.3 mm, cover 1.2 mm.
- Set includes two fuel can holders and a GN 1/1 – 65 mm food pan.

code	liters	mm
470305	9	660x490x(H)460

S.S.
stainless steel

ROLLTOP-CHAFING DISH - ROUND

- Elegant buffet chafing dish.
- Patented extra quiet opening mechanism.
- Roll-top cover retractable 180°.
- Set includes one fuel can holder and food pan (Ø 390x(H)60 mm).
- Highly polished stainless steel.
- Steel frame 2.3 mm, cover 1.2 mm thick.

code	liters	mm
470312	5.6	510x540x(H)480



INDUCTION HOT PLATE KITCHEN LINE

- Unique induction hot plate with a rectangular induction coil which keeps pans warm while providing freedom of placement.
- Power adjustable in 11 steps by means of a knob.
- Temperature range: 40-100°C.
- Equipped with electronic protection against overheating.
- Maximum load of the induction cooker: 15 kg.

code	V	W	mm
239384	230	800	460x315x(H)62



Works also with
a GN tray up to GN 1/2

800 W
230 V

239384

CHAFING DISH HEATER

- For use as an alternative to conventional fuel holder.
- Only suitable for chafing dishes with a flat bottom.
- Extremely suitable for chafing dishes without preparation for electrical elements.
- Specifically suitable for HENDI chafing dishes with item number 470008, 475201, 470206 and 471005.

code	V	W	mm
809600	230	500	ø130x(H)100



809600

DISH WARMER 2 BURNERS

- With stainless steel frame and grips.
- Anodized aluminium hotplate.
- Scratch-proof.
- Including 2 candle light holders.



code	mm
463000	330x180x(H)65



463000

DISH WARMER 3 BURNERS

- With stainless steel frame and grips.
- Anodized aluminium hotplate.
- Scratch-proof.
- Including 3 candle light holders.



code	mm
463109	450x180x(H)65



463109

CANDLE HOLDER



code	mm
464809	ø46x(H)20



464809

GAS LIGHTER - SET OF 2 PCS.

- Refillable.
- Supplied empty.

code	packed per	mm
198124	2	(L)230



198124



CHAFING DISH FUEL

- Chafing dish fuel is made from natural ethanol alcohol, mixed with water and a thickening agent to make it a solid or gel.
- HENDI chafing dish fuel is artificially made to taste so bitter that it is impossible to swallow.
- To safely and efficiently warm chafing dishes, we urgently advise to place the chafing dish fuel can in the indicated fuel holders.
- The heating capacity is equal throughout the range while the heating rate depends on the size of the flame, determined by the distance the lid of the chafing dish fuel can holder is kept open.
- All HENDI chafing dish fuel burn soot and odourless.
- Cartouches and cans burning without the chafing dish fuel can holder become very hot during use, creating a significant risk of burns if they are not placed inside the chafing dish fuel can holder. Danger of burns!
- These chafing dish fuel can holders are included with the HENDI chafing dishes and available separately.
- Always read the product instructions before use.
- Make sure there are no open flames or hot objects nearby when working with chafing dish fuel.
- The flammable vapour easily escapes from the container.
- Make sure that no water (condensation) drips into the burning fuel. It can cause dangerous sputtering and splashing of fuel.
- Only light the fuel after placing the chafing dish fuel can holder with can in the final location.
- The flames are almost entirely blue, making them very hard to see in the light. Caution is advised.
- Only ever extinguish the fuel by closing the lid of the chafing dish fuel can holder.
- Refilling: Always make sure the can and its holder have completely cooled down.
- Remove the can from the chafing dish fuel can holder to refill the can.
- Storage: Always store it in closed containers in a dark and well-ventilated location, below 20°C.
- To store larger amounts of fuel, please consult your local regulations.
- If the above instructions are followed, the risk of accidents will be minimal.
- In case of a starting/small fire: use a fire blanket (or a large, wet blanket) to cover the fire and deprive it of oxygen.
- In case of fire on clothes/body: use a fire blanket or a powder/CO₂ fire extinguisher.
- Never try to extinguish the fire with a small towel as this would only spread the fuel and the flames! After extinguishing the fire keep the body cool for 15 minutes or until medical assistance arrives.
- Leave clothes in place.
- Always seek medical assistance immediately.

Benefits:

- + Doesn't contain toxic methanol
- + Safe to use indoors
- + No toxic fumes or bad odours

194355



CHAFING DISH FUEL CAN NL DE FR EN

- 200 grams pack for chafing dish.
- Burning time: ± 3 hours.
- Pallet: 40x 194355, 117x 194300, 135x 194362.

code	packed per
194362	12
194300	24
194355	72



CHAFING DISH FUEL



195109

CHAFING DISH FUEL BOTTLE

- Bottle 1 liter.

code	order unit
195109	12



195505

CHAFING DISH FUEL JERRY CAN

- Jerry can 5 liter.

code	order unit
195505	4



190401

CHAFING DISH FUEL BUCKET

- Bucket 4 kilos.

code	order unit
190401	3



470527

CHAFING DISH FUEL CAN HOLDER - 2 PCS.



code	packed per	mm
470527	2	ø90x(H)60



195604

FUEL DISPENSER

- Suitable for e.g. can of chafing dish fuel 195505

code	mm
195604	(L)280



190036

FUEL FOR FONDUE-BURNERS - 3 PCS

- For gourmet, fondue, rechauds and stone grills.
- 80 grams portion packs.
- Burning time: ± 2 hours.
- For use with 111420.

code	packed per
190036	3



111420

FONDUE-BURNER - 2 PCS

- Suitable for fuel for fondue-burners.



code	packed per	mm
111420	2	ø92x(H)40

LIQUID FUEL WITH WICK

- HENDI tin with wick, contains 100% diethylene glycol.
- Burns up completely.
- Soot and odour free.
- Special wick provides proper burning temperature and time.
- The can does not overheat, no fuel holder needed.
- Equal flame temperature and height during the whole burning process.
- Box 4x6 tins.
- Due to the special cap, it is possible to use the same can several times, store it and transport it safely.



Burns ± 4 hours

193761



Burns ± 6 hours

193716

LIQUID FUEL WITH WICK

code		packed per	weight (kg)	order unit
193761	burns ± 4 hours	6	0.145	4
193952	burns ± 4 hours	24	0.145	1
193716	burns ± 6 hours	6	0.2	4
193938	burns ± 6 hours	24	0.2	1
193679	burns ± 8 hours	24	0.25	1

Adjustable wick length

Use the same can several times

The can doesn't get hot and doesn't leak when tilted



CHOCOLATE FOUNTAIN

- Made of stainless steel.
- With warming function, temperature can be set up to 150 °C.
- Minimal chocolate capacity: 1 kg.
- Maximal chocolate capacity: 8 kg.
- With separate switch for motor and heating element.



Watch the video



Chocolate fountain 3 tiers



Chocolate fountain 5 tiers



Chocolate fountain 6 tiers



	Chocolate fountain 3 tiers	Chocolate fountain 5 tiers	Chocolate fountain 6 tiers
code	274101	274156	274163
temperature control	45°C	110°C	150°C
min. capacity chocolate	1 kg	2,5 kg	2,5 kg
max capacity chocolate	1,5 kg	6 kg	8 kg
dimensions	ø210x(H)390	ø330x(H)700	ø370x(H)840
power/voltage	170 W/230 V	265 W/230 V	300 W/230 V



LADLES AND SERVING SPOONS BUFFET SUPREME

18/10
stainless steel



SERVING SPOON

code	mm
529058	305x60
529065	321x71

SLOTTED SPOON

code	mm
529072	321x71

SOUP LADLE

code	liters	mm
529089	0.05	270x69
529096	0.09	308x85

CHAFING DISH LADLES AND SERVING SPOONS

- With polypropylene handle



PP polypropylene S.S. stainless steel

SKIMMER

code	mm
529201	345x75

SERVING SPOON

code	mm
529300	350x75

SOUP LADLE

code	liters	mm
529003	0.09	335x90
529010	0.11	300x80

SKIMMER, ROUND

code	mm
529041	370x105

CARVING FORK

code	mm
529102	345x32

SLOTTED SPATULA

code	mm
529409	355x80

S.S. stainless steel

SPOON HOLDER

code	mm
722107	115x270x(H)45



722107



LADLES AND SERVING SPOONS, HEAT RESISTANT



SALAD SPOON

code	mm
563908	305x65

SALAD FORK

code	mm
564004	305x65

SOUP LADLE

code	colour	liters	mm
563502	White	0.07	235x75
563557	Black	0.07	235x75
563700	White	0.14	300x93
563755	Black	0.14	300x93



SALAD SPOON

code	colour	mm
564158	Black	235x55
564202	Transparent	235x55
564103	White	235x55

SALAD SPOON

code	colour	mm
564455	Black	335x90
564400	White	335x90

SAUCE LADLE

code	colour	liters	mm
563649	Black	0.03	180x70
563632	Ivory	0.03	180x70



SERVING TONGS

657607



657621



657669

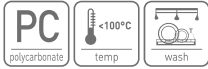

UNIVERSAL TONGS

code	colour	mm
657621	Transparent	(L)230
657607	Black	(L)230



UNIVERSAL TONGS

code	colour	mm
657669	Black	(L)250
657676	Black	(L)300

171622



171608



PASTRY TONG

code	mm
171622	(L)276
171608	(L)220

171615



CAKE TONGS

- Decorative tongs.

code	mm
171615	(L)220

BUFFET PRODUCTS



523018



523315



523216



PASTRY TONG

code	mm
523018	(L)215

SALAD TONGS

code	mm
523315	(L)212



SPAGHETTI TONGS

code	mm
523216	(L)200





261309



261347



261354



CONVEYOR TOASTER DOUBLE

- Two rows of bread slices fit next to each other on the conveyor.
- Two separate heating elements.
- Suitable for continuous toasting of sliced bread.
- Supplied with front and back trays.
- Adjustable toasting time up to 3 minutes.

code	colour	V	W	mm
261309	Steel	230	2240	418x368x(H)387
261347	Red	230	2240	418x368x(H)387
261354	Black	230	2240	418x368x(H)387

426982



426920

426999



BREAD BASKET ROUND

- Reinforced with a stainless-steel wire frame.
- Available in multiple colours.



code	colour	mm
426920	Beige	ø400x(H)90
426982	Black	ø400x(H)90
426999	Brown	ø400x(H)90

426289



ROLL TOP FOR BREAD BASKET ROUND

- Fits bread basket 426920, 426982 & 426999.
- With easy opening.

code	mm
426289	ø405x(H)230



426562



426586



426579



426593



BAKERY BASKET ANGLED ROUND

code	colour	mm
426562	Light grey	ø310x(H)120
426579	Black	ø310x(H)120
426586	Light grey	ø370x(H)120
426593	Black	ø370x(H)120

BASKET RISER

code	mm
426814	ø250x(H)180
426821	ø250x(H)265



426821



426814

426524



426555



426661



426678



BAKERY BASKET WITH STAINLESS STEEL RIM

code	colour	mm
426555	Black	400x300x(H)50
426524	Light grey	400x300x(H)50

BAKERY BASKET ANGLED

code	colour	mm
426678	Black	400x300x(H)120
426661	Light grey	400x300x(H)120





426272

BASKET DISPLAY

- Set of powder coated steel frame and 3 baskets.
- Baskets: 335x215x(H)80 mm

code	mm
426272	350x215x(H)600



426517

BAGUETTE BASKET

code	mm
426517	305x320x(H)350

426753

426685

426692



426715

426722

426746

BAKERY BASKET GN SIZE

- Reinforced with a stainless steel frame.

code	-	mm
426746	GN 1/6	176x162x(H)65
426722	GN 1/4	265x162x(H)65
426715	GN 1/3	325x176x(H)65
426692	GN 1/2	325x265x(H)65
426753	GN 2/3	325x354x(H)65
426685	GN 1/1	530x325x(H)65



426722

426715





BASKETS



561102

BREAD BASKET GN 1/1

- Reinforced with a stainless steel wire frame.

code	mm
561102	530x320x(H)90



561201

BREAD BASKET DISPLAY GN 1/2

- Set of 2 baskets with chrome-plated stand.
- Baskets reinforced with a stainless-steel wire frame.
- Basket dimensions: 360x280x(H)90 mm.
- Stand isn't dishwasher safe.

code	mm
561201	360x280x(H)290



561003

BREAD BASKET OVAL

- Reinforced with a stainless steel wire frame.

code	mm
561003	380x270x(H)90



BASKET WITH ROLL TOP COVER

- Basket made of heavy duty polypropylene (poly-rattan).
- Roll top hood made of polycarbonate.

code	GN	mm
426968	GN 2/3	365x335x(H)245



426968



561102



561003



426968



561201





424186

COOLED DISPLAY WITH COVER - GASTRONORM 1/1

- Cooling by included ice pack, to go below 0°C.
- Stainless steel Gastronorm 1/1 serving tray included.
- With transparent polycarbonate cover.
- ABS housing.

code		mm
424186	set	555x357x(H)175
424193	cooling element for use with cooling tray 424186	528x324x(H)30



424193



COOLING DISPLAY TRAY

- 5-piece set:
- Base made of polystyrene.
- Tray made of stainless steel, with a profiled rim.
- Transparent cover made of ABS.
- 2 cooling elements.
- NOTE: Before freezing, fill in the cooling element with water up to 90% of its volume.
- The tray is also sold separately (code: 871829).

code	mm
424155	430x290x(H)150



424155





871805



871812



ROLL-TOP COOLING DISPLAY SINGLE

- 5-piece set:
 - Base made of ABS.
 - Tray made of stainless steel, with a profiled rim.
 - Transparent roll-top cover made of SAN, opened upwards up to 90°.
 - 2 cooling elements.
- NOTE: Before freezing, fill in the cooling element with water up to 90% of its volume.

code	mm
871805	440x320x(H)205

ROLL-TOP COOLING DISPLAY DOUBLE

- 9-piece set:
 - 2-level base made of ABS.
 - 2 trays made of stainless steel, with a profiled rim.
 - 2 transparent roll-top covers made of SAN, opened upwards up to 90°.
 - 4 cooling elements.
- NOTE: Before freezing, fill in the cooling element with water up to 90% of its volume.

code	mm
871812	440x320x(H)440



NEW

ROLL TOP DISPLAY, DOUBLE-PURPOSE, SINGLE DECK

- Made of polypropylene with a stainless steel insert.
- Transparent Rolltop cover made of polystyrene.
- Convenient access to served food from both sides of the display case.
- Two functions: cooling or heating display.
- Cooling/heating elements placed under the stainless steel tray to maintain the temperature in the compartment.
- Easy to clean.
- Designed and produced 100% in Italy.
- The set includes 2 gel inserts for cooling or heating.
- Dishwasher safe.



871775



code	mm
871775	465x315x(H)195





871706

ROLL TOP DISPLAY – SINGLE

- Made of ABS plastic.
- Transparent SAN plastic rolltop cover.

code	mm
871706	465x310x(H)190



871713

ROLL TOP COOL DISPLAY TRAY DOUBLE DECK

- Transparent Roll Top cover made of polystyrene.
- Convenient access to served food from both sides of the display case.
- Easy to clean.
- Dishwasher safe.

code	mm
871713	465x310x(H)410
871768	380x260x(H)355

NEW



424001



ROUND DISPLAY ROLL-TOP COVER

- Tray made of stainless steel, with a profiled rim.
- Cover made of SAN, with a chrome button, opened one-sidedly up to 90° (included in set).
- Tray is dishwasher safe.
- The cover is also sold separately (code: 427514).

code	mm
424001	ø380x(H)240
427514	Round roll-top cover ø380x(H)200



980101



ROUND TRAY WITH COVER

- Tray made of stainless steel, with handles.
- Cover made of SAN, with an extruded grip.
- Both elements of the set are dishwasher safe.

code	mm
980101	ø300x(H)110





427507

ROLLTOP PRESENTATION COVER
- Clear polycarbonate.



code	mm
427507	540x330x(H)180



866009

PRESENTATION COVER GN 1/1



code	mm
866009	545x335x(H)95



427538

ROLLTOP PRESENTATION COVER GN 2/3
- Clear polycarbonate.



code	-	mm
427538	Roll top cover only	365x335x(H)175



427415

PRESENTATION COVER GN 1/1



code	mm
427415	530x325x(H)76





ROTATING CAKE STAND

- Made of stainless steel.
- Effortless base rotation in both directions facilitating decorating and cutting cakes.
- On a stable foot with non-slip base.
- The cover is also sold separately (code: 523834).

code	mm
523827	ø300x(H)90



523834

523827

CAKE STAND COVER

- Made of polystyrene.
- Transparent, with an extruded grip.
- Not dishwasher safe.
- Suitable for the HENDI Rotating cake stand (code: 523827).

code	mm
523834	ø300x(H)110

CAKE SERVER

- With polypropylene handle.



code	mm
523902	260x55



523902

CAKE SCOOP/CUTTER

- Black polypropylene handle.
- Thanks to its sharpened edges it can be used as a knife.



code	mm
523957	300x75



523957



SERVING STANDS



SERVING STAND FOR PLATES

code	plates max.	mm
425466	Ø 170 mm	185x175x(H)260
425473	Ø 275 mm	290x290x(H)440

SEA FOOD TRAY STAND

- With two serving trays, Ø 300/400 mm.

code		mm
480519	-	Ø400x(H)200
480502	Stand only	Ø250x(H)190

TIERED STAND

- With 3 trays, Ø 166/220/268 mm.

code	mm
429914	Ø268x(H)320



561966



561973



561980



561997

NON-SLIP DISPLAY STANDS

- Steel frame with PVC coating.
- Supports a variety of display trays and bowls.

code	mm
561973	265x230x(H)200
561966	260x230x(H)100

NON-SLIP DISPLAY STANDS ROUND

- Steel frame with PVC coating.
- Supports a variety of display trays and bowls.

code	mm
561980	Ø200x(H)100
561997	Ø200x(H)200





557402



MUESLI DISPENSER

- Designed for dispensing bulk products.
- Stainless steel stand.
- Polycarbonate dispenser.
- Airtight lid to retain long freshness of the ingredients.
- Hygienic, controlled dosing prevents spillage.
- Dispenser opening located at a height of 140 mm.
- Mountable – can be placed on a worktop or wall-mounted.

code	liters	mm
557402	4	184x240x(H)600



428245



MULTIRACK

- Frame made of polished AISI 304 stainless steel.
- 3 levels, for pre-packed products and condiments.
- 3 removable 1 L containers, made of SAN.
- Containers are dishwasher safe.

code	mm
428245	190x240x(H)410



425138

JUICE JUG

- Straight model of scratch resistant plastic with lid.

code	liters	mm
425138	2	ø120x(H)250



425107

PITCHER WITH ICE TUBE

- Pear shaped model of scratch resistant clear SAN plastic with lid.
- With ice cube tube for cooling.

code	liters	mm
425107	2.2	ø150x(H)260
425121	3	ø170x(H)285



567906

PITCHER

- Very break resistant.

code	liters	mm
567906	1.8	ø125x(H)210



425763

CARAFE

- Cover with pourer.

code	liters	mm
425763	1	ø92x(H)245



DISPENSERS AND JUGS



425299



425411

JUICE DISPENSER

- With ice cylinder cooling.
- Easy to clean dripping tray.
- Clear polycarbonate juice container.
- With non-drip tap.

code	liters	mm
425299	8	265x350x(H)580
425411	16	560x350x(H)580



425428



425435

JUICE DISPENSER

- With ice cylinder cooling.
- Easy to clean dripping tray.
- Clear polycarbonate juice container.
- With non-drip tap.

code	liters	mm
425428	3	215x315x(H)490
425435	6	415x315x(H)490





425190



JUICE DISPENSER

- With ice cube cooling.
- Clear polycarbonate juice container.
- With non-drip tap.

code	liters	mm
425190	5	280x220x(H)510



425343



MILK DISPENSER - 10,5 L

- Stainless steel housing.
- With ice cylinder cooling.
- Removable container with non-drip tap.
- Stable bottom plate with dripping tray.

code	liters	mm
425343	10.5	260x360x(H)536



JUICE DISPENSER 2X12L

- Two 12 liter containers with quick dispense tap.
- With temperature controller, temperature can be set between 0°C and 10°C.
- Containers can be removed to ease cleaning.
- Refrigerant: R290.
- Drip tray included.

code	liters	V	W	mm
425206	24	230	370	430x430x(H)640



425206



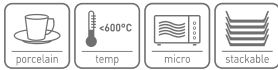

GN CONTAINERS MADE OF PORCELAIN

- Made of white, glossy porcelain.
- Made of the most durable porcelain available on the market.
- Resistance to extreme temperature changes.
- High resistance to physical impacts.



783009

GASTRONORM PAN GN 1/1

code	-	order unit	mm
783009	GN 1/1	3	530x325x(H)65



783016

GASTRONORM PAN GN 1/2

code	-	order unit	mm
783016	GN 1/2	6	325x265x(H)65



783023

GASTRONORM PAN GN 1/3

code	-	order unit	mm
783023	GN 1/3	8	325x176x(H)65



785010

DRESSING POT

code	order unit	liters
785010	18	1



MELAMINE

- Hygienic and shock resistant.
- Light weight.



566008

566015

GN BANQUET TRAY

code	-	mm
566046	GN 1/4	265x152x(H)20
566022	GN 1/3	325x177x(H)20
566015	GN 1/2	325x265x(H)20
566053	GN 2/4	530x163x(H)20
566930	GN 2/3	354x325x(H)20
566008	GN 1/1	530x325x(H)20



PLATTER, RECTANGULAR

code	mm
561508	360x205x(H)38
561515	495x270x(H)56



561607



GN 1/1 TRAY

code	mm
561607	530x325x(H)20



SQUARE BOWL

code	colour	mm
561560	<input type="checkbox"/> White	130x130x(H)65
561577	<input type="checkbox"/> White	190x190x(H)100
561584	<input type="checkbox"/> White	270x270x(H)105

561560





436103



SERVING TRAY GN 1/1

- Polished, with matt rim.
- Made of stainless steel.
- Suitable for cooling tray 424186.

code	mm
436103	530x325x(H)13



807705



BANQUET TRAY GN 1/1 WITH SMOOTH RIM

code	mm
807705	530x325x(H)10



410110



SERVING TRAY GN 1/1, WITH SLANTED RIM

code	mm
410110	530x325x(H)20



871829



COOLING DISPLAY TRAY

- Made of stainless steel.
- With a profiled rim that holds the cover in place.
- Fits into set: the HENDI cooling tray with cover (code: 424155) and the HENDI cooling displays (codes: 871805 and 871812).

code	mm
871829	395x283



SERVING TRAY, ROUND

- Decorative pattern.
- Made of stainless steel.

code	mm
480205	ø300x(H)17
480403	ø400x(H)19



807804



BANQUET TRAY GN 1/1, WITH DECORATIVE RIM

- Made of stainless steel with a polished finish.
- Embellished rim with embossed decorative patterns.
- Dishwasher safe.
- Suitable for the HENDI Cooling tray (code: 424186).

code	-	mm
807804	GN 1/1	530x325





405000

SERVING TRAY, OVAL

- Satin finish.
- Made of stainless steel.



code	mm
405000	200x140
405208	265x195
405307	285x220



480106

BEER TRAY



code	mm
480106	ø315x(H)45

SERVING DISH



code	mm
404003	190x140
404102	245x170
404201	300x220
404300	350x240
404409	400x260
404508	450x290
404607	500x350



FAST FOOD TRAYS

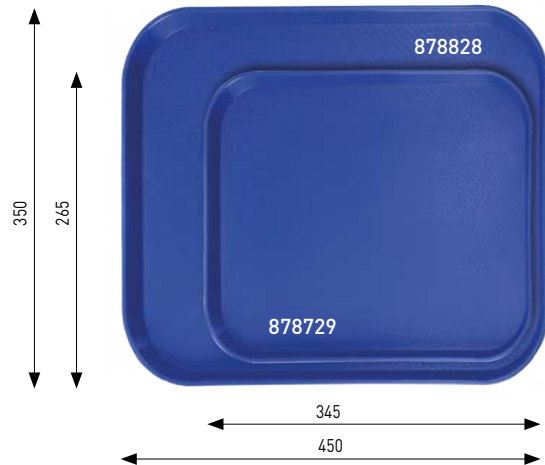
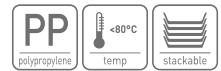

POLYPROPYLENE FAST FOOD TRAY, SMALL

code	colour	mm
878705	Light grey	265x345x(H)20
878712	Red	265x345x(H)20
878729	Blue	265x345x(H)20
878736	Green	265x345x(H)20
878743	Brown	265x345x(H)20
878750	Black	265x345x(H)20

POLYPROPYLENE FAST FOOD TRAY, MEDIUM

code	colour	mm
878903	Light grey	305x415x(H)20
878910	Red	305x415x(H)20
878927	Blue	305x415x(H)20
878934	Green	305x415x(H)20
878941	Brown	305x415x(H)20
878958	Black	305x415x(H)20

POLYPROPYLENE FAST FOOD TRAY, LARGE

code	colour	mm
878804	Light grey	350x450x(H)20
878811	Red	350x450x(H)20
878828	Blue	350x450x(H)20
878835	Green	350x450x(H)20
878842	Brown	350x450x(H)20
878859	Black	350x450x(H)20



POLYPROPYLENE EURONORM



878101



878125



878606

SERVING TRAY, RECTANGULAR, NON-SLIP, BLACK

- Black.

code	mm
878118	255x355
878101	530x325

SERVING TRAY, ROUND, NON-SLIP - Black.

code	mm
878125	$\varnothing 280 \times (H) 20$
878132	$\varnothing 360 \times (H) 20$
878149	$\varnothing 410 \times (H) 20$

SERVING TRAY, ROUND, NON-SLIP - Black.

code	mm
878606	$\varnothing 320 \times (H) 37$
878408	$\varnothing 360 \times (H) 39$



878507



878552



POLYPROPYLENE FAST FOOD TRAY, OVAL - Oval-shaped, with a low rim

code	colour	mm
878507	Light grey	265x195x(H)15
878552	Black	265x195x(H)15



SERVING TRAY WITH MELAMINE LAMINATE, NON SLIP, WITH WOOD DESIGN

- Finished with melamine laminate
- Excellent resistance to chemicals, stains, and scratches.
- Available in 3 different, elegant designs.

code	colour	mm
508909	Wood light	240x340
508916	Wood	240x340
508923	Wood dark	240x340
508862	Wood light	330x430
508879	Wood	330x430
508886	Wood dark	330x430
508930	Wood light	370x530
508947	Wood	370x530
508954	Wood dark	370x530



FIBREGLASS

- Fibreglass reinforced polyester.
- Ideal for heavy use scenarios.
- Non-slip rubber surface, effective both wet and dry.
- Shockproof, break resistant.

- Can be cleaned in a professional dishwasher with a short program. Can't be cleaned in a dishwasher intended for household use.



508657

POLYESTER TRAY, NON-SLIP, RECTANGULAR

- Black.

code		mm
508657		200x280
508626		325x530
508619	Euronorm	370x530



508817

POLYESTER TRAY, NON-SLIP, ROUND

- Black.

code	mm
508824	ø280x(H)22
508817	ø350x(H)22
508800	ø400x(H)22
508794	ø460x(H)22
508787	ø500x(H)22



508718

POLYESTER TRAY, NON-SLIP, OVAL

- Black.

code	mm
508718	160x230
508725	200x265
508732	210x290



508831



POLYESTER TRAY, OVAL, XL

- Black.

code	mm
508831	735x600



810507

COLLAPSIBLE TRAY STAND

- High quality materials, sturdy construction.
- Fitted with black belts, easy to set up.



code	mm
810507	520x410x(H)800



SERVING TRAYS, NON-SLIP

- Laminated trays with rubber non-slip coating.
- Resistant to chemicals, stains, and scratches.



507216



507865



507711

SERVING TRAY, RECTANGULAR, NON-SLIP, LAMINATED

code	mm
507216	325x530
507469	330x430
507117	370x530
507018	430x610

SERVING TRAY, ROUND, NON-SLIP, LAMINATED

code	mm
507865	ø380x(H)15

SERVING TRAY, ROUND, NON-SLIP, HIGH RIM, LAMINATED

code	mm
507711	ø320x(H)35
507766	ø360x(H)30
507773	ø420x(H)30

SERVING TRAY, OVAL, NON-SLIP, LAMINATED

code	mm
507964	230x160
507568	200x265
507933	290x210



507933



507568

GRANITE FORM



876602



POLYESTER TRAY, FOR SELF-SERVICE RESTAURANTS

- Perfect for canteens and self-service bars.
- Rectangular, smooth, colour: granite.
- Professional quality, exceptional material durability.

code	mm
876602	265x325
876619	530x325

Space between trays for better air circulation.

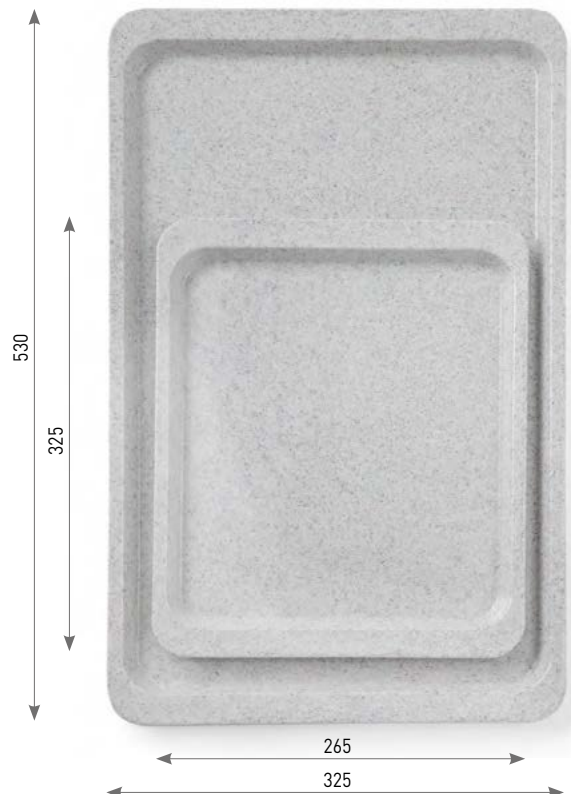



CUTLERY TRAY

- 4 sections GN 1/1.

code	colour	mm
552315	Black	530x325x(H)100
552308	Light grey	530x325x(H)100



552315

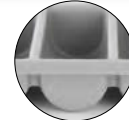

552308



CUTLERY TRAY

- 6 sections.

- Suitable for coffee spoons, teaspoons and cake forks GN 1/1.

code	colour	mm
552353	Light grey	530x325x(H)105
552360	Black	530x325x(H)105



552360

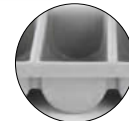

552353



CUTLERY BASKET HOLDER

- For 4 baskets.

- Baskets not included.

code	mm
552407	255x295x(H)215



552407

POLYPROPYLENE CUTLERY BASKET

code	mm
871201	ø97x(H)137



871201

STAINLESS STEEL CUTLERY BASKET

code	mm
552490	ø97x(H)137



552490



CATERING FURNITURE FOLDABLE

- Multi-functional foldable furniture for indoor and outdoor use.
- Tops made of HDPE polyethylene.
- Frame made of powder-coated metal profiles.

- Easy transport and storage.
- Easy to clean and stain resistant surfaces.



BUFFET TABLE FOLDABLE

- Foldable to suitcase model for easy transporting and storage.

code	mm
810927	1520x700x(H)740
810910	1830x750x(H)740

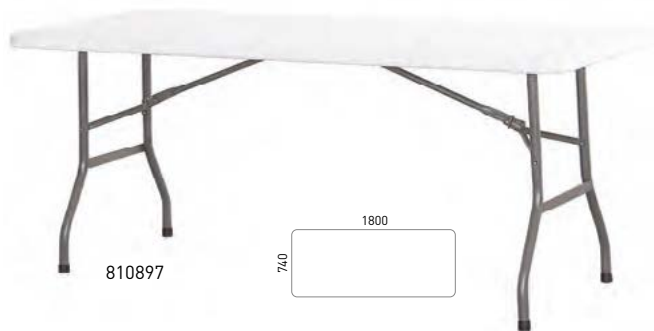

BUFFET TABLE

code	mm
810347	870x870x(H)740
810897	1800x740x(H)740



TROLLEY FOR TABLES

- Eases transport of round and square tables.
- Can hold up to 10 round tables upright or 20+ rectangular tables stacked.

code	mm
811221	1800x850x(H)990





810958

ROUND BAR TABLE

code	mm
810958	ø800x(H)1100



810934

BUFFET TABLE

code	mm
810934	1220x610x(H)740



813157



813164

TABLE COVER SYMPOSIUM, ROUND



- Fabric: plain jersey 160 g/m².
- 90% micro polyester, 10% elastan.
- No ironing needed.
- Excellent color fastness.
- Fits tables with table top diameters ø800-850.

code	colour	mm
813157	White	ø850x(H)1150
813171	Cream	ø850x(H)1150
813164	Black	ø850x(H)1150



813829



813836

TABLE COVER SYMPOSIUM, ROUND Ø70-85 CM



- Fabric: plain jersey 160 g/m².
- 90% micro polyester, 10% elastan.
- No ironing needed.
- Excellent color fastness.
- Fits tables with table top diameters ø700-850.

code	colour	mm
813829	White	ø850x(H)1150
813850	Cream	ø850x(H)1150
813836	Black	ø850x(H)1150

TABLE COVER SYMPOSIUM, RECTANGULAR

- Fabric: plain jersey 160 g/m².
- 90% micro polyester, 10% elastan.
- No ironing needed.
- Excellent color fastness.

code	colour	-	mm
814376	Black	810934	1200x760x(H)730
814390	White	810927	1500x760x(H)730
814406	Black	810927	1500x760x(H)730
814420	White	810910 810897	1830x760x(H)730
814437	Black	810910 810897	1830x760x(H)730



814437

814420





810996



BUFFET TABLE ROUND FOLDABLE

- Foldable to suitcase model for easy transporting and storage.

code	mm
810996	ø1500x(H)740



BENCH

- Foldable to suitcase model for easy transporting and storage.

code	mm
811191	1830x300x(H)430

811191



810965

CATERING CHAIR - LIGHT GREY

code	mm
810965	540x440x(H)840



810989

CATERING CHAIR - BLACK

code	mm
810989	540x440x(H)840



813096

FOLDING CHAIR COVER

- Fabric: President 170 g/m².
- 100% polyester.
- No ironing needed.

code	colour	mm
813096	White	540x440x(H)840

NEW

ABS
plastic



3 notification modes:



RESTAURANT CALLING SYSTEM

- Digital displays on pagers for marking order/table number (programmable numbers from 001 to 998).
- Controller with a touch keypad.
- Built-in antenna in the controller ensuring no signal interference from other devices.
- 3 notification modes: vibration, sound, LED light.
- Combine notification modes – all switched off with one click.
- Space-saving charging: pagers are stacked on the charger.
- Reach: 500 m.
- Pager dimensions: 65x65x15 mm.
- Max. pagers programmable into 1 controller: 998.
- Included in set: controller, 10 pagers, charging station, charger.
- Pagers are also sold separately – 10 pcs. (code: 201640).

code
201633

RESTAURANT PAGERS – SET OF 10 PCS.

- Digital displays on pagers for marking order/table number (programmable numbers from 001 to 998).
- 3 notification modes: vibration, sound, LED light.
- Combining notification modes – all switched off with one click.
- Space-saving charging: pagers are stacked on the charger.
- Reach: 500 m.
- Pager dimensions: 65x65x15 mm.
- Included in set: 10 pagers, charging station, USB-C cable.
- Pagers operate only with the controller from the HENDI Restaurant calling system – sold separately (code: 201633).

code
201640



CORKSCREWS & BOTTLE OPENERS



596807



WAITER'S CORKSCREW

- Chrome plated, with.
- ABS handle 4 functions With separate bottle-opener

code	mm
596807	(L)140



597200



WAITER'S CORKSCREW

- Curved model 3 functions.

code	mm
597200	(L)110



Foliesnijder

597323



WAITER'S CORKSCREW

- Made of stainless steel, ABS grip.
- 3 functions.
- Patented lever, spiral for long corks and foil cutter.

code	mm
597323	37x130x(H)14



594018



WAITER'S FRIEND CORKSCREW

- Waiter's friend with corkscrew, blade and bottle cap opener.
- The long corkscrew allows to open bottles without breaking or bending the cork.
- The small blade cuts through foil with ease.
- With a durable steel frame which is covered with a gripped casing.
- Folds away compact and is easy to carry in a pocket.

code	mm
594018	110x25



Watch the video



643914



BOTTLE OPENER WITH CATCHER BIN

- This bottle opener is intended to be mounted on the wall.
- Bin can be easily removed to ease emptying.
- Supplied with two screws and wall plugs.

code	mm
643914	135x70x(H)295

WALL MOUNTED BOTTLE OPENER

code	mm
596883	



596883



WAITER'S CORKSCREW

- With metal handle.
- 3 functions.
- With extra kink in lever for long corks.

code	mm
597316	(L)120



Watch the video





597507



CORKSCREW

- Lever model.
- Chrome-plated.
- With bottle-opener.

code	mm
597507	(L)170



596746

BAR BLADE



code	mm
596746	179x40x(H)2

POURERS



599334

SLOW POURER WITH FLIP TOP - 6 PIECES

- For use in bars, pubs and restaurants
- Facilitates precise dosing
- Made of stainless steel with rubber stopper
- Suitable for standard 0.5 - 1.5 liter bottles with holes up to ø20 mm in diameter



code	packed per	mm
599334	6	ø30x120



599488

599464

599471

FREE-FLOW POURER

code		packed per
599488	Fast flow	6
599464	Slow flow	6
599471	With flip top	6



599372

FREE-FLOW POURER - 6 PCS

- EVA plastic.

code	packed per
599372	6





599402 599419 599426 599433

FREE-FLOW POURER SET - 4 PCS

- EVA plastic.

code			packed per
599402	■	Blue	4
599419	■	Red	4
599426	□	Transparent	4
599433	■	Yellow	4



599440 599457

FREE-FLOW POURER SET - 4 PCS

- EVA plastic.

code		packed per
599440	2 black, 2 white, 2 red	6
599457	2 blue, 2 red, 2 green	6

ABS
plastic

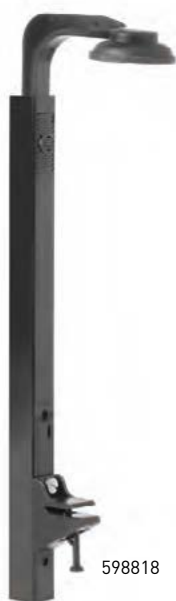

598818

wall mounted



598719

shelf mounted



NON-DRIP BRACKET WALL MOUNTED

- Bottle height: 240-350 mm.
- For shelves up to 35 mm thick.

code	
598719	shelf mounted
598818	wall mounted



598016 598214 598313 598412

NON-DRIP POURER

code	liters
598313	0.04
598214	0.035
598016	0.02
598412	0.05



599013 599112 599198 599211

BALL MEASURING POURER - 2 PCS

code	packed per	liters
599013	2	0.02
599112	2	0.035
599198	2	0.04
599211	2	0.05

SAN
plastic





552049

BOTTLE STOPPER – 3 PCS.

- Prevents leaks and spills of the beverage
- Hermetic seal extends the life of the product in an already opened bottle
- Made of nylon with a very durable ABS lever
- Integrated silicone ring that seals the bottle tightly when the lever is pressed
- Suitable for standard bottles with a capacity of 0.5 - 1.5 litres, holes up to $\varnothing 20$ mm in diameter
- Includes 3 caps in green, white and red

code	packed per	mm
552049	3	$\varnothing 36 \times 81$



595572



BOTTLE CAP PERFORATOR

- "Prikít".
- Perforates bottle caps and cans easily with a $\varnothing 6,5$ mm hole.
- Passing a straw through the hole keeps insects out of the drink.
- Reduces spillage if a drink is knocked over.
- Suitable for 6 mm biodegradable straws.

code	mm
595572	$\varnothing 45 \times (H) 80$



595589



CHAMPAGNE STOPPER

- For storing opened bottles.
- With silicone gasket.

code
595589



595558

STOPPER – 6 PCS.

- For use in bars, pubs and restaurants
- Made of hard and flexible black EVA
- Protect against spillage of open bottles
- Sealed closure to extend product life
- Suitable for standard 0.5 - 1.5 liter bottles with holes up to $\varnothing 20$ mm in diameter

code	packed per	mm
595558	6	$\varnothing 31 \times 31$



595565

STOPPER WITH CAP – 6 PCS.

- For use in bars, pubs and restaurants
- Protect against spillage of open bottles
- Made of hard and flexible EVA
- Sealed closure to extend product life
- Suitable for standard 0.5 - 1.5 liter bottles with holes up to $\varnothing 20$ mm in diameter

code	packed per
595565	6



557600



STORE & POUR BOTTLE

- Intended for storing and serving juices and pre-mixes.
- Supplied with 5 coloured spouts, red, blue, green, orange, yellow.
- Made of polypropylene and polystyrene.
- Completely detachable, all parts have a secure fit.
- Spout provides an even flow thanks to the air hole.
- Comes with a screw on lid for storing.
- Suitable for dishwasher cleaning.

code	colour	liters	mm
557600	Red	0.8	$\varnothing 90 \times (H) 300$

INGREDIENT BOXES

- For use in bars, pubs and restaurants
- Made of premium plastics
- HIPS enclosure and transparent ABS lid to protect food from contamination or insects
- Each container can be easily removed from the holder, e.g. to replenish the product
- Dishwasher safe containers



552018



552025



552131



552032

CONDIMENT HOLDER - 3 CONTAINERS

- 3 polypropylene containers to store fruit or spice additives separately

code	mm
552018	480x150x(H)100

CONDIMENT HOLDER - 4 CONTAINERS

- 4 polypropylene containers to store fruit or spice additives separately

code	mm
552025	480x150x(H)100

CONDIMENT HOLDER - 5 CONTAINERS

- 5 polypropylene containers to store fruit or spice additives separately

code	mm
552131	480x150x(H)100

CONDIMENT HOLDER - 6 CONTAINERS

- 6 polypropylene containers to store fruit or spice additives separately

code	mm
552032	480x150x(H)100



552100

CONDIMENT HOLDER

- Made of top-quality materials.
- Stainless steel with transparent polypropylene lid to protect food from contamination or insects.
- Polypropylene storage containers for storing additives or spices separately. The containers can be easily lifted out of the holder.
- Containers are dishwasher safe.

code	-	mm
552100	5 containers	375x140x(H)90



596890

NAPKIN HOLDER WITH 3 COMPARTMENTS

- For use in any food and beverage establishment
- Made of polystyrene
- Large napkin compartment 135x135 mm
- Two smaller compartments measuring 24x115 mm for straws, stirrers, etc.

code	mm
596890	193x143x(H)136



596760

BAR CADDY

- 6 compartments for organizing straws, napkins, stirrers, etc.
- Container for napkins 130x130 mm, 2 compartments 51x48 mm, 2 compartments 51x44 mm, 1 compartment 102x46 mm.
- Made of ABS plastic.

code	mm
596760	240x145x(H)105



PARING KNIVES AND PEELERS

- High quality

PARING KNIFE

- Made in Germany.



code	-	blade length (mm)	mm
841105	straight model	75	(L)180
841112	pointed model	87	(L)190
841129	curved model	60	(L)165

TOMATO KNIFE

- Polypropylene handle.

- Made in Germany.



code	blade length (mm)	length (mm)
841136	110	215



CUTTING BOARD WITH HANDLE

- Made of polyethylene HDPE.

- Both sides suitable for cutting.



code	colour	mm	thickness (mm)
826348	<input type="checkbox"/> White	250x150	10
826478	<input checked="" type="checkbox"/> Black	250x150	10
826355	<input type="checkbox"/> White	300x200	10
826485	<input checked="" type="checkbox"/> Black	300x200	10



MUDDLER

- Made of polypropylene .

- For grinding and crushing drink ingredients, e.g. raspberries, limes, mint etc.



code	-	mm
596739	profiled, grid	ø34x207
596944	smooth	ø34x207
596951	profiled, star-shaped	ø34x207





593097



BAR SPOON

code	mm
593097	27x27x(H)266



593325



BAR SPOON

- Made of copper-plated stainless steel.

code	mm
593325	27x20x(H)450



596968



BAR SPOON TWISTED

code	mm
596968	(L)380



523520



ICE CUBE TONGS

- Packed per 2.

code	mm
523520	(L)180



596685



JULEP STRAINER

code	mm
596685	xx(H)



638118



BAR SIEVE

- Made of stainless steel
- Thin mesh with wire handle

code	mm
638118	ø65x220



638149



BAR SIEVE PVD COATED

- Stainless steel finished with elegant black PVD coating
- Thin mesh with wire handle
- NOTE: Not dishwasher safe

code	mm
638132	ø65x220
638149	ø75x220



638170



BAR SIEVE CONICAL PVD COATED

- Stainless steel finished with elegant black PVD coating
- Thin mesh with wire handle
- NOTE: Not dishwasher safe

code	mm
638170	ø75x220



638163



BAR SIEVE CONICAL

- Made of stainless steel
- Thin mesh with wire handle
- Dishwasher safe

code	mm
638163	ø75x220



596753



STRAINER

code	mm
596753	82x28x(H)165



596975



596982

MUG COPPER PLATED

- Made of stainless steel, copper plated.
Polished finish.

code	-	liters	mm
596975	Mule mug	0.5	ø97x(H)100
596982	Beer mug	0.4	ø85x(H)105



S.S.
stainless steel



593035

**COCKTAIL SHAKER
CONICAL**

code	liters	mm
593035	0.75	ø90x(H)255

S.S.
stainless steel



593004

COCKTAIL SHAKER
- Made of stainless steel.

code	liters	mm
593004	0.75	ø80x(H)240

S.S.
stainless steel



50 ml

596722

25 ml

JIGGER

- Dual, 25 ml and 50 ml.

code	mm
596722	ø43x(H)85

S.S.
stainless steel



50 ml

596920

25 ml

JIGGER WITH RING

- Made of stainless steel with extra ring for weight and stability.

- Dual, 25 ml and 50 ml.

code	mm
596920	ø43x(H)110

S.S.
stainless steel



593318

TIN TIN COCKTAIL SHAKER

- Made of copper-plated stainless steel.
- 2-piece.
- 2 shakers 600/800 ml: ø90x(H)140 mm / ø92x(H)174 mm.

code	mm
593318	ø92

S.S.
stainless steel



50 ml

593332

25 ml

JIGGER

- Made of copper-plated stainless steel with ring for extra weight and stability.

- Dual, 25 ml and 50 ml.

code
593332

S.S.
stainless steel



50 ml

596654

25 ml

JIGGER WITH RING

- For use in bars, pubs and restaurants
- Made of stainless steel
- Ring for optimal weight and stability in the hand
- Elegant black colour
- Double-sided, 25 ml and 50 ml

code	mm
596654	ø45x(H)110

S.S.
stainless steel



593066

BOSTON SHAKER

code	-	liter
593066	mixing glass	0.45
593042	shaker	0.8

S.S.
stainless steel



593042

BOSTON SHAKER BLACK

code	liters
596678	0.8

S.S.
stainless steel



35 ml

596715

25 ml

JIGGER

- Made of stainless steel.
- Dual, 25 ml and 35 ml.

code	mm
596715	ø40x(H)73

S.S.
stainless steel



35 ml

596647

25 ml

JIGGER BLACK

- Made of stainless steel
- Double-sided
- Elegant black colour

code	ml	mm
596630	25/35	ø40x(H)75
596647	25/50	ø45x(H)86

NEW



700259

BARTENDER BAG

- Made of thick cotton with plain weave. The bag has a rim with overstitching for reinforcement and an elegant finish.
- Stainless steel fittings finished in an antique gold colour.
- Straps made from brown natural leather (suede).
- Black cotton shoulder strap adjustable in length and detachable.
- Secure fastening by means of buckles and leather straps.
- Lay-out:
 - 8 pockets (e.g. for bartending spoons, tweezers),
 - 8 elastic open compartments (e.g. for jiggers),
 - 3 flaps secured with velcro,
 - zippered compartment for a shaker/boston shaker glass, measuring 37x15 cm.
- Dimensions of the internal part (with closed flaps): 37x33,5 cm.

code

700259



596777



ABS
plastic

3-TIER GLASS RIMMER

- For decorating glass rims.
- 3 appropriately labelled tiers: lime juice, salt, sugar.
- Sponge in lime juice container to prevent spilling.
- Made of ABS plastic.

code

596777

mm

200x160x(H)75



594704

S.S.
stainless steel



594742

S.S.
stainless steel

U
user assembly

593608



ICE BUCKET - DOUBLE WALLED

code	liters	mm
594704	5	ø200x(H)230

ICE BUCKET WHITE

code	liters	mm
594742	5	ø190x(H)200
594759	10	ø292x(H)220

WINE COOLER STAND

- Very compactly packed 4-part assembly.

code	mm
593608	ø185x(H)750





471500



PARTY TUB

code	liters	mm
471500	13.5	ø370x(H)230



471524



PARTY TUB

code	liters	mm
471524	9.5	ø350x(H)230



593165



PARTY TUB

- Made of transparent plastic.
- Transparent.
- Oval.

code	mm
593165	470x290x(H)230



593202



WINE COOLER

- With ring handles.
- The large format ensures that most wine bottles fit without problems.

code	liters	mm
593202	3.3	ø220x(H)190



593103



WINE COOLER

- With tulip handles.

code	liters	mm
593103	3.5	ø210x(H)210



593158



CHAMPAGNE COOLER

- Transparent.
- Compatible with wine cooler table bracket 593905.

code	liters	mm
593158	3	220x185x(H)226



593905



WINE COOLER TABLE BRACKET

- The ring is ø 185 mm, so most wine coolers will fit.
- The mounting rods are finished with rubber ends to prevent damage.
- Wine cooler not included.

code	mm
593905	ø195x(H)510



For use without ice cubes

593806



WINE COOLER

- Double-walled stainless steel.
- For use without ice cubes.
- Inside diameter: 105 mm.

code	mm
593806	ø120x(H)180

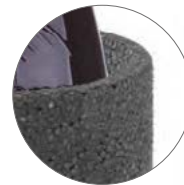

Light weight but highly insulating

593813



WINE COOLER EPP

- Made of EPP, highly insulating.
- Stable heavy bottom, unbreakable.
- The temperature of the wine rises at about 1.5°C per hour, keeps wine cool longer than regular steel coolers.

code	mm
593813	ø142x(H)210



679012



ICE CUBE MOULDS ASSORTED GEMS

- Ideal for cocktails, a must have for bar professionals.
- Consists of 2 moulds, each creating 6 gem-shaped ice cubes.
- Made of durable, food-grade silicone.

code	mm
679012	190x105x(H)30



679043



ICE CUBE MOULD MINI CUBE

- For preparing 15 small ice cubes ($\pm 3 \times 3 \times 3$ cm).
- Made of durable, food-grade silicone.

code	mm
679043	190x120x(H)35



679036



ICE CUBE MOULD XL CUBE

- For preparing 6 large slow-melting ice cube balls ($\pm 5 \times 5 \times 5$ cm).
- Made of durable, food-grade silicone.

code	mm
679036	170x110x(H)52



679029



ICE CUBE BALL MOULD

- Ideal for whisky, a must have for bar professionals.
- Creates 6 big spherical shaped ($\pm \varnothing 4,5$ cm), slow melting ice cubes.
- Consists of 2 parts with locking ring so the balls can be made without leaking.
- Made of durable, food grade silicone.

code	mm
679029	180x125x(H)50



679050



ICE SHOT GLASS MOULD

- Ideal for serving shots, a must have for bar professionals.
- Creates 6 shot glass shaped ice cubes.
- Made of durable, food grade silicone.

code	mm
679050	125x190x(H)60



679067



ICE SHOT GLASS MOULD

- For preparing 4 shot glass-shaped ice cubes.
- Made of durable, food-grade silicone.

code	mm
679067	122x122x(H)60



679005

Soft rubber in holder

ICE CUBE TRAY WITH LID

- Made of soft rubber.
- Capacity: 32 cubes.

code	mm
679005	335x180





S.S.
stainless steel

588574

Al aluminium
wash
micro



588420

SODA SIPHON

- Stainless steel soda siphon.
- Makes fresh carbonated water in no time.
- Requires carbon dioxide chargers for use.

code	liters	mm
588574	1	ø100x(H)320

KITCHEN LINE CREAM WHIPPER

- Matte black coated aluminium bottle and head.
- Not suitable for preparing hot sauces.
- Supplied with: 3 different polypropylene nozzles and a cleaning brush.
- To be used with cream whipper chargers (N₂O) (chargers not included).

code	liters	mm
588420	0.5	ø80x(H)260



588406

SODA CHARGERS - 10 PCS

- Contains 8 grams of CO₂, a single filling of a 1L soda siphon.

code	packed per
588406	10



CREAM WHIPPER CHARGERS

- Suitable for commercially available cream dispensers.
- N₂O Best before 5 years after production date.

code	packed per
588208	10
588215	24
586907	50



696002

GLASS BRUSH STANDARD

- Polypropylene with 3 nylon brushes.
- Bottom plate fitted with 4 suction pads.



code	mm
696002	190x100x(H)180



696040

GLASS BRUSH HIGH

- Polypropylene with 3 nylon brushes.
- Bottom plate fitted with 4 suction pads.



code	mm
696040	190x100x(H)250



552681

GLASS BRUSH ROUND

- Aluminium with nylon brush.
- Bottom plate fitted with 4 suction pads.



code	mm
552681	ø150x(H)190



597972

597989

BAR MAT

code	mm
597989	300x150x(H)9
597965	610x85x(H)15
597972	453x305x(H)15

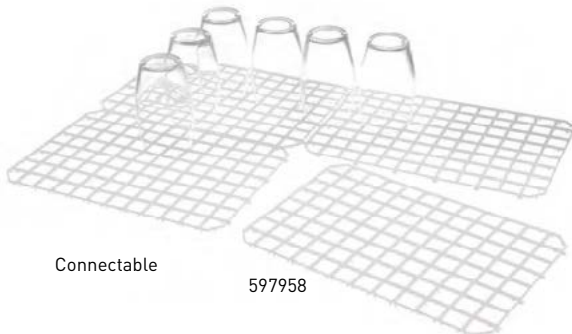

Connectable

597958

DRAINAGE MAT

- Made of white polypropylene.
- Connectable.
- HACCP compliant.



code	packed per	mm
597958	5	313x209





CITRUS JUICER

- Lever model, chrome-plated.
- Made of high quality zinc alloy.
- With handle for increased stability.
- Lever folds back easily using a spring.
- Stainless steel juice bowl and cone.

code	mm
695906	225x180x(H)510

695906



592069



592052



592045



CITRUS SQUEEZERS

- Aluminium alloy with powder coating.

code	-	mm
592069	orange (for oranges)	232x91x(H)60
592052	yellow (for lemons)	223x75x(H)45
592045	green (for limes)	203x60x(H)40





425206



JUICE DISPENSER 2X12L

- Two 12 liter containers with quick dispense tap.
- With temperature controller, temperature can be set between 0°C and 10°C.
- Containers can be removed to ease cleaning.
- Refrigerant: R290.
- Drip tray included.

code	liters	V	W	mm
425206	24	230	370	430x430x(H)640



NEW



274255



274224



SLUSH MACHINE

- 12 liter container with quick dispense tap, the lids are lit.
- Digital temperature controller with cold beverage and slush modes.
- Efficient compressor, in slush mode temperature varies between -10°C and -2°C.
- Containers can be removed to ease cleaning.
- Day and night mode.
- Refrigerant: R290.
- Drip tray included.

code	liters	V	W	mm
274255	12	230	740	470x520x(H)810



SLUSH MACHINE 2X12L

- Two 12 liter containers with quick dispense tap, the lids are lit.
- Digital temperature controller with cold beverage and slush modes.
- Efficient compressor, in slush mode temperature varies between -10°C and -2°C.
- Containers can be removed to ease cleaning.
- Day and night mode.
- Refrigerant: R290.
- Drip tray included.

code	liters	V	W	mm
274224	24	230	740	470x520x(H)810





221204



221099

CITRUS JUICER ELECTRIC

- Made of rust-resistant material.
- With stainless steel squeeze bowl.
- Including 3 interchangeable.
- ABS cones for small and large citrus fruit.
- ABS sieve.
- Speed 1500 RPM.
- Manually operated by means of on/off switch.
- Including polycarbonate anti-splash cover.
- All elements except the body are dishwasher safe.

code	V	W	mm
221204	230	180	308x218x(H)463

CITRUS JUICER ELECTRIC

- Top with lever provides easy and safe operation.
- Removable bowl and cone of stainless steel.
- With splash screen.
- RPM: 980/min.

code	V	W	mm
221099	230	230	280x200x(H)470



3 cones for different sizes of fruit



Splash screen
Stainless steel bowl



Top with lever provides easy and safe operation





221105



CENTRIFUGAL JUICE EXTRACTOR

- For making juice of hard and soft fruits or vegetables.
- With a large, 7 liter, pulp container.
- Very powerful, can juice up to 120 kg per hour.
- Housing, bowl, juicer basket and grating disk made of stainless steel.
- Feeder tube and pusher made of ABS, pulp container and lid made of polypropylene.

- Motor spins the grating disk at 3000 rpm.
- Safe in operation, will only work if the lid and safety arm are locked into place.
- Very easy to disassemble and clean.
- Not suitable for ice or frozen fruits/vegetables.

code	V	W	mm
221105	230	700	246x480x(H)531



BLENDER WITH NOISE COVER

- This blender can prepare anything: fruits, vegetables, cocktails, smoothies, desserts and even crushed ice.
- Replaceable stainless steel blades with titanium coating.
- Noise cover made of polycarbonate, for safety the blender only works when the cover is completely closed.
- Comes with 2,5L break-resistant BPA free Tritan jug, firm lid made of polypropylene and a small BPA free Tritan lid cover.



- Detachable jug can withstand temperatures of -40°C up to 90°C.
- Hi-speed motor with variable speed and pulse function drives the blades from 8350 RPM up to 24800 RPM (without load).
- Equipped with over-heat and over-current protection.



Watch the video

230688
230602



Watch the video

Noise cover reduces sound significantly

Anti-slip base

230695
230664

BLENDER WITH NOISE COVER

- Manual control panel power setting knob and a pulse switch.

code	V	W	mm
230688	230	1680	252x258x(H)547
230602	BPA free	230	1680
			252x258x(H)547

DIGITAL BLENDER WITH NOISE COVER

- Digital control panel has touch control for three power settings, three time settings and a pulse function.

code	V	W	mm
230695	230	1680	252x258x(H)547
230664	BPA free	230	1680
			252x258x(H)547

Stainless steel knife with titanium coating



Solid construction of the gear



Durable metal gear socket





HIGH POWER BLENDER

- This blender can prepare anything: fruits, vegetables, cocktails, smoothies, desserts and even crushed ice.
- Replaceable stainless steel knife with titanium coating.
- Manual control panel, power setting knob and a pulse switch.
- Comes with 2,5L break-resistant polycarbonate jug, firm lid made of ABS and a small polycarbonate lid cover.
- Detachable jug can withstand temperatures of -40°C up to 90°C.
- Hi-speed motor with variable speed and pulse function drives the blades from 16000 RPM up to 24800 RPM (without load).
- Equipped with over-heat and over-current protection.

code	V	W	mm
230718	230	1680	270x250x(H)550
230213	BPA free	230	1680

Very powerfull,
can even crush ice

Comes complete with
2,5L break-resistant
jug, pusher and firm lid

230718



BLENDER JAR BPA FREE

- Replacement jar for blender 230718/230695/230688/230213/230602/230664.
- 2,5L break-resistant BPA free Tritan jug, firm lid made of polypropylene and a small BPA free Tritan lid cover.
- Fitted with blades made of stainless steel with titanium coating.

code	mm
933688	200x170x(H)360



933688



BLENDER JAR WITH TITANIUM COATED BLADE

- Replacement jar for blender 230718/230695/230688/230213/230602/230664.
- 2,5L break-resistant polycarbonate jug, firm lid made of polypropylene and a small polycarbonate lid cover.
- The jar is fitted with blades made of stainless steel with titanium coating.

code	mm
943489	200x170x(H)360



943489



**PERFECT FOR
PREPARING FREDDO
CAPPUCCINO,
FRAPPÉ AND
MILKSHAKES**



design by
Robert Bronwasser

Powerful motor with two speeds:
15,000 and 19,000 rpm.



221600 221617 221624 221631 221648 221655

2 sets of replaceable
polycarbonate stirrers
(2 pieces each)



2 cups: made of stainless
steel (capacity: 0.95 l)
and of polycarbonate
(capacity: 0.9 l)

MILKSHAKE MIXER - DESIGN BY BRONWASSER

- Designed by Dutch Designer Robert Bronwasser and available in 6 attractive colours.
- Make Freddo cappuccinos, Frappés and of course milkshakes without effort.
- The housing is made from ABS plastic.
- The base is weighted for extra stability and is fitted with rubber feet.
- The motor can spin the agitator disc at two speeds, 15,000 and 19,000 RPM.
- Control the milkshake mixer with the two-speed switch on the top which is easily accessible.
- The milkshake mixer is fitted with a micro switch so it can only operate when the cup is properly placed.
- Choose between two different stirrers to control the level of aeration.
- Very complete, comes with a stainless steel mixing cup (0.95 liter) and polycarbonate mixing cup (0.9 liter) and 2 sets of 2 stirrers.
- Cups and stirrers are dishwasher safe.

code	colour	V	W	mm
221617	White	230	400	170x196x(H)490
221600	Black	230	400	170x196x(H)490
221624	Caramel	230	400	170x196x(H)490
221631	Yellow	230	400	170x196x(H)490
221648	Red	230	400	170x196x(H)490
221655	Blue	230	400	170x196x(H)490

221631

BAR



NEW



MILKSHAKE MIXER BPA FREE - DESIGN BY BRONWASSER

- Designed by Dutch Designer Robert Bronwasser.
- Make Freddo cappuccinos, Frappés and of course milkshakes without effort.
- The housing is made from ABS plastic.
- The base is weighted for extra stability and is fitted with rubber feet.
- The motor can spin the agitator disc at two speeds, 15.000 and 19.000 RPM.
- Control the milkshake mixer with the two-speed switch on the top which is easily accessible.
- The milkshake mixer is fitted with a micro switch so it can only operate when the cup is properly placed.
- Choose between two different agitators to control the level of aeration.
- Included in the set: stainless steel mixing cup (0.95 liter), tritan mixing cup (0.9 liter) and a set of 2 tritan stirrers.
- Cup and agitators are dishwasher safe.

code	colour	V	W	mm
221495	Black	230	400	170x196x(H)490



POLYCARBONATE MIXING CUP FOR MILKSHAKERS - DESIGN BY BRONWASSER

- Made of durable polycarbonate.
- To be used with milkshakers:
- 221600, 221617, 221624, 221631, 221648, 221655.
- Dishwasher safe.



961124

code	mm
961124	ø116x(H)161



STAINLESS STEEL MIXING CUP FOR MILKSHAKERS - DESIGN BY BRONWASSER

- Made of stainless steel.
- To be used with milkshakers:
- 221600, 221617, 221624, 221631, 221648, 221655.
- Dishwasher safe.



961117

code	mm
961117	ø113x(H)160



NEW

STIRRERS BPA-FREE FOR MILKSHAKE MIXERS - DESIGN BY BRONWASSER

- Made of tritan - BPA-free material.
- The set includes 2 pieces: single and double stirrer.
- Specially created for the HENDI Milkshake mixer - Design by Bronwasser, code: 221495.
- Dishwasher safe.



957066

code	mm
957066	32x27x(H)50



NEW

STIRRERS FOR MILKSHAKE MIXERS - DESIGN BY BRONWASSER

- Made of polycarbonate.
- The set includes 2 pieces: single and double stirrer.
- Specially created for the HENDI Milkshake mixers - Design by Bronwasser: codes 221600, 221617, 221624, 221631, 221648, 221655, 221495.
- Dishwasher safe.



961131

code	mm
961131	32x27x(H)50





271520



Watch the video



695708



ICE CRUSHER – ELECTRIC

- Large ABS plastic ice chute and brushed stainless steel housing.
- Stainless steel blades and durable grinding mechanism.
- Clear, break resistant container with capacity for 12 cups of crushed ice.
- Crushes up to 12 kilos of ice per hour.
- Not for continuous use.

code	V	W	mm
271520	230	70	170x260x(H)460

ICE CRUSHER – MANUAL

- Chrome-plated zinc alloy.
- Stainless steel blade.
- Ice scoop included.
- Removable container.

code	mm
695708	160x140x(H)270

ICE CRUSHER ELECTRIC

- Cup and stainless steel blades made of AISI 301 stainless steel.
- Motor housing made of cast aluminium.
- Powerful ventilated motor – it can handle a full cup of ice without overheating.
- Hinged lid, equipped with a safety microswitch.
- Cup capacity: 3 L.
- Cup wall thickness: 0.8 mm.
- Knife speed: 1000 RPM.
- Crushing a full cup of ice takes ±30 s.
- Output: 160 kg/h.
- Water protection rating: IP23.

code	V	W	mm
271599	230	200	194x329x(H)523

SAFETY SENSOR
It makes it impossible to start up in an open processing space.

HORIZONTAL BREAKER
Stainless steel blades set on horizontal drive plates – fast and effective processing up to 120 kg/h.

LONG SERVICE LIFE OF THE DRIVE UNIT
The fan uses the energy of rotation of the crushing axis while cooling the motor.

BASE SHOCK ABSORBERS
They eliminate vibrations and prevent spontaneous movement of the device.



271599

BAR



ABS
plastic

18/0
stainless steel



271568



271551



3 ice cube sizes possible



3 ice cube sizes possible

ICE CUBE MACHINE - 12 KG

- Tabletop model.
- Body made of stainless steel, lid made from black ABS.
- Capacity of 12 kg per 24 hours, buffer stock of 3,2 kg - 9 cubes per cycle.
- No fixed water connection - coolant: R600A.
- Choice of 3 ice cube sizes, cubes are formed around cooling rods.
- Stores 100 ice cubes.

code	V	W	mm
271568	230	120	297x367x(H)378

ICE CUBE MACHINE - KITCHEN LINE 15

- Tabletop model.
- Body made of stainless steel.
- Capacity of 15 kg per 24 hours, buffer stock of 4,5 kg - 12 cubes per cycle.
- No fixed water connection - coolant: R290.
- Choice of 3 ice cube sizes, cubes are formed around cooling rods.
- Holds 150 ice cubes.

code	V	W	mm
271551	230	130	380x435x(H)431



521410

ALUMINIUM ICE SCOOP

code	mm
521410	220x80

Al
aluminium



521434

ALUMINIUM ICE SCOOP SLOTTED

code	mm
521434	220x80

Al
aluminium

Electronic control



271773

BULLET ICE CUBE MAKER

- Makes bullet shaped ice cubes that are partially hollow.
- Housing completely made from stainless steel.
- Can store up to 7 kg of ice.
- Inlet & outlet hoses and ice scoop included.
- Climate class: ST.
- Refrigerant: R290.

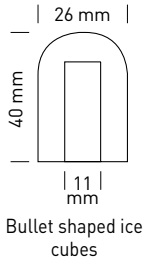

code	-	V	W	mm
271773	~26 kg/day	230	241	398x546x(H)682
271780	~50 kg/day	230	293	398x546x(H)682



271797

FLAKE ICE MAKER

- Produces flakes of ice.
- Housing made entirely of stainless steel.
- Ice container capacity: up to 20 kg.
- Inlet & outlet hoses and ice scoop included.
- Climatic class: ST.
- Refrigerant: R290.



code	-	V	W	mm
271797	~85 kg/day	230	430	548x612x(H)867



271575

Cubes need to be separated from each other



ICE CUBE MACHINE

- Stainless steel casing suitable for installation under the counter.
- Can produce up to 35 kg of ice per day and has buffer stock for 15 kg.
- Produces 45 square ice cubes per cycle of 13-16 minute.
- Cubes need to be separated from each other.
- Comes with supply hose and ice scoop.
- Air-cooled injection system, coolant R290.

code	V	W	mm
271575	230	300	448x400x(H)798



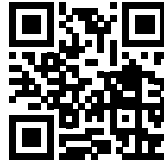

Watch the video



TABLE BEER TAP

- Plexiglas.
- With strong non-drip tap.

code	liters	mm
598955	3	ø100x(H)815
598962	5	ø100x(H)1150

598955



598962



696200

BEER GLASS CARRIER

- For 12 glasses, 55 mm hole diameter.

code	mm
696200	ø315x(H)35



565360

BEER SKIMMER

- White, made of plastic.

code	mm
565360	235x26



COIN TOKENS - 100 PCS.

code	packed per	colour	mm
665145	100	Red	ø25
665138	100	Green	ø25
665121	100	Blue	ø25
665152	100	White	ø25
665169	100	Black	ø25
665381	100	Yellow	ø25



516751

BEER BUCKET

- With bottle opener integrated in the handle.

code	mm
516751	ø230x(H)180



BACK BAR REFRIGERATORS



- Powder coated housing, embossed aluminium chamber, plastic lockable door(s) with toughened glass.
- Forced air cooling with auto-defrost, compressor placed underneath the chamber.
- Chamber fitted with LED lighting.
- Digital display and temperature control.
- Fitted with 4 adjustable non-slip feet.
- Refrigerant: R600a.

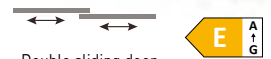
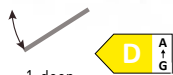

	1-door	2-door	Double sliding door
code	233900	235829	233917
capacity	93 L	180 L	197 L
dimensions	500x500x(H)900 mm	900x500x(H)900 mm	900x500x(H)900 mm
shelves	2 chrome plated	4 chrome plated	4 chrome plated
range	2/10°C	2/10°C	2/10°C
coolant	R600a	R600a	R600a
energy class	D	D	E
power/voltage	130 W/230 V	160 W/230 V	220 W/230 V



	Triple sliding door	1-door	2-door
code	235836	233924	233931
capacity	303 L	287 L	448 L
dimensions	1335x500x(H)900 mm	600x515x(H)1820 mm	900x515x(H)1820 mm
shelves	6 chrome plated	5 chrome plated	10 chrome plated
range	2/10°C	2/10°C	2/10°C
coolant	R600a	R600a	R600a
energy class	E	E	E
power/voltage	215 W/230 V	240 W/230 V	300 W/230 V

BAR





WINE COOLERS, DUAL ZONE

- Two cooling zones with the possibility to set different temperatures in each of them.
- Black powder-coated housing, frameless tempered glass door with stylish stainless steel handle.
- Static cooling supported with a fan, automatic defrosting, chiller located at the back of the cooler.
- LED light at the top of the chamber.



- Digital display and electronic thermostat.
- Temperature displayed in degrees Celsius, possibility to switch to Fahrenheit.
- 4 adjustable non-slip feet.
- Climatic class: N-ST.
- Refrigerant: R600a.

THE IDEAL TEMPERATURE OF SPECIFIC WINES (FROM REDS TO WHITES):

Temperature	Types of wine
18°C	Bordeaux, Cabernet Sauvignon, Shiraz
16°C	Rioja, Pinot Noir
15°C	Chianti, Zinfandel
14°C	Chinon, Porto, Madeira
10°C	Chardonnay, Sauternes
9°C	Sauvignon Blanc
6°C	Champagne Non Vintage, Prosecco, Cava, Asti



code	237588	237557	237564	237595
capacity	133 L max 46 bottles of wine	232 L max 72 bottles of wine	387 L max 135 bottles of wine	447 L max 160 bottles of wine
dimensions	595x588x(H)820 mm	595x605x(H)1225 mm	595x680x(H)1625 mm	595x685x(H)1795 mm
shelves	5 wooden	9 wooden	13 wooden	15 wooden
range	5/22°C	5/22°C	5/22°C	5/22°C
coolant	R600a	R600a	R600a	R600a
energy class	G	G	G	G
climatic class	N-ST	N-ST	N-ST	N-ST
power/voltage	90 W/230 V	110 W/230 V	130 W/230 V	150 W/230 V





208632

PALM TAMPER ADJUSTABLE

- Suitable for most portafilters.
- Pre-tamper made of stainless steel, handle made of black aluminium.
- The depth is adjustable.

code	mm
208632	ø58x(H)35



208625

COFFEE TAMPER WITH SPRING

- Used to compact coffee, suitable for most portafilters.
- Tamper made of stainless steel with spring.
- Black aluminium handle.

code	mm
208625	ø58x(H)100



208731

COFFEE TAMPER

- Used to compact coffee, suitable for most espresso machines.
- Tamper made of stainless steel.
- Wooden painted handle.
- Weight: 380 g.

code	mm
208731	ø58x(H)95



208670

TAMPING MAT

- Made of silicone, with recess for placing a portafilter during tamping.
- With a socket to place the tamper in.

code	mm
208670	125x140x(H)30



208649

TAMPING MAT DOUBLE

- Made of silicone, with recess for placing 2 portafilters during tamping.
- With two sockets to place the tampers in.

code	mm
208649	205x150x(H)45



208687

TAMPING STAND

- With recess for placing a portafilter during tamping.
- With a socket to place the tamper in.

code	mm
208687	93x142x(H)60



208724



GROUP HEAD CLEANING BRUSH

- Easily brush coffee residue from the group head and portafilter of espresso machines.
- Tough brush made of nylon.
- Measuring spoon for cleaning agents.
- Splash screen keeps the handle dry.
- Set of 2 pcs.

code	mm
208724	(L)225





208694

KNOCK BOX RECTANGULAR

- Drawer model made from carbon steel.
- Fitted with removable knock bar and perforated top.

code	mm
208694	350x250x(H)90



208335



KNOCK BOX GN

- Made from stainless steel.
- Removable knock bar fitted with silicone sleeve.

code	mm
208342	265x162x(H)100
208335	176x162x(H)100



208380



KNOCK BOX IN WOODEN FRAME

- Frame made from dark wood, with a stainless steel GN 1/4 knock box.
- Removable knock bar fitted with silicone sleeve.

code	mm
208380	275x175x(H)110



271247

MILK FROTHING THERMOMETER

- With a clip to fasten the thermometer to the milk jug.
- Green marking indicates the perfect milk temperature for cappuccino etc.
- Temperature adjustable from -10°C to 110°C.
- 1°C gradation, accuracy: ±2%.
- Stainless steel probe, cover with clip.
- Easy to read.

code	range	mm
271247	-10/110°C	ø44x(H)140



458198

MILK JUG BLACK

- Made from stainless steel with a black non-stick coating.

code	liters	mm
458198	0.6	ø90x(H)112



451045

MILK JUG - MATT BLACK

- Made of extra thick stainless steel, helps keep the content hot.
- V-shaped spout gives extra control during pouring.

code	liters	mm
451045	0.7	ø84x(H)130



208618

ROUND KNOCK BOX

- Made from stainless steel.
- Fitted with removable knock bar.

code	mm
208618	153x185x(H)165



451533

MULTIPURPOSE JUGS

code	liters	mm
451502	0.35	ø76x(H)93
451519	0.6	ø90x(H)112
451526	0.9	ø102x(H)125
451533	1.5	ø112x(H)161



COFFEE MACHINE

- Makes a can of coffee in about 6 minutes.
- Design casing made of polypropylene with black rubber coating.
- With 1.8 liter glass decanter, polypropylene filter holder and lid.
- With 2 separately operated warming plates.
- With indicator light that shows when the coffee is ready.
- Suitable for 110/250 filters.

code	V	W	mm
208533	230	2020	204x380x(H)425



445907



208656



DECANTER

- Toughened glass with polypropylene handle and lid.



code	liters	mm
445907	1.8	ø160x(H)185

COFFEE FILTERS Ø 25 CM - 1000 PCS

- For i.e. HENDI, Bravilor and Animo coffee machines.
- Diameter of the entire filter - 250 mm.
- Bottom diameter of the filter - 110 mm.

code	packed per	mm
208656	1000	ø250x(H)70





208304

COFFEE MACHINE

- Top and bottom hotplate, indicator light.
- Fast filtering system with flow-through element - 1.8 litres in 5 minutes.
- Continuous temperature of 93 - 96°C.
- Casing and filter holder made of stainless steel.
- 2 x 1.8 l decanters and 25 (90/250) filters are included.

code	V	W	mm
208304	230	2100	195x370x(H)430



904206

SPRING FOR COFFEE FILTER HOLDER

code
904206



ELECTRIC MILK FROTHER

- Housing and milk jug made of stainless steel with a handle made of ABS.
- 6 functions: hot thick milk foam, hot thin milk foam, cold milk foam, warm milk, hot chocolate, tea with hot milk.
- The milk jug is detachable for easy pouring.
- Capacity - frothing: 300 ml / heating: 600 ml.
- Jug diameter: 130 mm.
- For use with cold milk.
- Lid and whisk are dishwasher safe.
- Included in the set: lid, whisk accessories.
- The frothing effect also can be achieved with vegan milks, such as oats, almond, soya; preferably "Barista" type. The effect may vary depending on the milk producer.

code	V	W	mm
209097	230	500	200x167x(H)245

209097





Control panel with digital display



209936



ELECTRIC KETTLE - 2,5 L

- Perfect for intensive use.
- With fast-boil.
- Separate power base for easier kettle handling, enabling full 360° rotation of the kettle.
- Fitted with ergonomic polypropylene handle.
- With heating indicator light.
- Heater placed under the bottom, protected against limescale.
- Automatic switch-off when water boils.
- With dry-boil protection, doesn't work without water.
- AISI 304 stainless steel housing and bottom.
- Weight: 1.12 kg

code	liters	V	W	mm
209936	2.5	230	2150	225x168x(H)288



209943



CORDLESS ELECTRIC KETTLE WITH TEMPERATURE CONTROL

- For preparing beverages with indicated brewing conditions, such as green tea, white tea, or yerba mate.
- AISI304 stainless steel housing and heater.
- Polypropylene handle, lid, and base.
- Temperature regulation and maintenance – water can be heated to one of these temperatures: 40°C, 60°C, 80°C, 100°C.
- Heater placed under the bottom, protected against scale.
- Control panel with digital display.
- Thermostat indicator light.
- Internal maximum water level indicator.
- Automatic shut-off function after the water boiled.
- Double protection against switching on an empty kettle.
- Kettle can be rotated – 360° base.
- CAUTION: intended for boiling water only, boiling other liquids may damage the kettle.

code	liters	V	W	mm
209943	1.8	230	1800	225x168x(H)288



Bain-Marie heating system prevents hot chocolate from being burned to the bottom



Watch the video



HOT CHOCOLATE DISPENSER

- Bain-Marie heating system prevents hot chocolate from being burned to the bottom.
- Bottom of the container is made of stainless steel.
- Side walls are made of Polycarbonate.
- Drip tray with float indicator warning when full.
- Protection against overheating.
- Continuous stirring guarantees homogeneous consistency of chocolate.
- Special anti-drip tap.
- Temperature range: 65 to 85°C.
- Required temperature of environment: 10 to 32°C.

code	liters	V	W	mm
274125	5	230	1006	410x280x(H)465
274149	10	230	1006	410x280x(H)580



274125

274149



240700



HOT DRINKS BOILER

- Kettle made from stainless steel.
- Fitted with polypropylene insulated handles and non-drip tap.
- Thermostat adjustable up to 110°C.
- Ideal for mulled wine or hot water.
- Time needed for boiling \pm 75 min.
- Not suitable for chocolate milk.

code	liters	V	W	mm
240700	25	230	2500	447x441x(H)485



240601



HOT DRINKS BOILER

- Kettle made from coated stainless steel.
- Fitted with polypropylene insulated handles and non-drip tap.
- Thermostat adjustable up to 110°C.
- Ideal for mulled wine or hot water.
- Time needed for boiling \pm 75 min.
- Not suitable for chocolate milk.

code	liters	V	W	mm
240601	25	230	2500	447x441x(H)485



AUTOMATIC FILL BOILER



- Made from brushed stainless steel with polypropylene lid and handles.
- The double walled kettle increases heating efficiency and insulation.
- When connected to the water mains the boiler will refill automatically.
- Fitted with two waterlevel sensors.
- Control panel fitted with digital display and heating and keep warm indicator lights.
- Temperature can be set from 30°C up to 100°C .
- With keep warm function, auto power down and overflow prevention sensor.

- The non-drip tap is made from stainless steel, has a cool touch handle, and is installed so a pot can be placed underneath it.
- Lid fitted with a twist-lock and cool touch handles.
- Comes with a removable drip tray.
- Available in 2 sizes:
 - 240717 – max. capacity 8.5 l, can boil up to 23 l/h.
 - 240724 – max. capacity 17.5 l, can boil up to 33 l/h.

Works also
without water
mains connection



code	liters	V	W	mm
240717	8.5	230	2000	300x285x(H)503
240724	17.5	230	2600	353x345x(H)598

Connection to
the water supply



Control panel with
digital display



The tap is made of
stainless steel
with a nice-to-touch handle



PERCOLATOR AND HOT DRINKS BOILER MATT BLACK - DESIGN BY BRONWASSER



- Designed with your guests in mind by renowned Dutch designer Robert Bronwasser.
- The unique design and attention for details make this appliance an eye-catcher on any buffet.
- Single walled matt black coated stainless steel body, with stylish polypropylene handles and lid.
- Unique non-drip tap design with integrated graduated glass.

- The drip tray is magnetic, it can be removed without lifting or spilling.
- The boiler keeps the drink at serving temperature after boiling.
- The indicator light signals the end of the boiling process and if descaling is needed.



design by
Robert Bronwasser



211472



211458

PERCOLATOR MATT BLACK - DESIGN BY BRONWASSER

- Filter pan has built-in filter for coarsely ground coffee, filter paper not needed.
- The percolator keeps the coffee at serving temperature after brewing.

code	liters	V	W	mm
211489	14	230	1750	357x380x(H)502
211472	7	230	1050	307x330x(H)450

HOT DRINKS BOILER MATT BLACK - DESIGN BY BRONWASSER

- The boiler keeps the drink at serving temperature after boiling.
- The indicator light signals the end of the boiling process and if descaling is needed.
- Not suitable for chocolate milk.

code	liters	V	W	mm
211458	9	230	950	307x330x(H)450
211465	16	230	1650	357x380x(H)502

Unique non-drip tap design with integrated graduated glass



The drip tray is magnetic



The boiler keeps the drink at serving temperature after heating



PERCOLATOR AND HOT DRINKS BOILER - DESIGN BY BRONWASSER



- Designed with your guests in mind by renowned Dutch designer Robert Bronwasser.
- The unique design and attention for details make this appliance an eye-catcher on any buffet.
- Single walled stainless steel body, with stylish polypropylene handles and lid.
- Unique non-drip tap design with integrated graduated glass.

- The drip tray is magnetic, it can be removed without lifting or spilling.
- The boiler keeps the drink at serving temperature after heating.
- The indicator light signals the end of the heating process and if descaling is needed.



design by
Robert Bronwasser



211434



211410

PERCOLATOR - DESIGN BY BRONWASSER

- Filter pan has built-in filter for coarsely ground coffee, filter paper not needed.
- The percolator keeps the coffee at serving temperature after brewing.

code	liters	V	W	mm
211441	14	230	1750	357x380x(H)502
211434	7	230	1050	307x330x(H)450

HOT DRINKS BOILER - DESIGN BY BRONWASSER

- The boiler keeps the drink at serving temperature after boiling.
- The indicator light signals the end of the boiling process and if descaling is needed.
- Not suitable for chocolate milk.

code	liters	V	W	mm
211410	9	230	950	307x330x(H)450
211427	16	230	1650	357x380x(H)502

Unique non-drip tap design with integrated graduated glass



The drip tray is magnetic



The boiler keeps the drink at serving temperature after heating



PERCOLATORS AND HOT DRINKS BOILERS

- Single walled stainless steel body.
- Filter pan has built-in filter for coarsely ground coffee, filter paper not needed.
- The percolator keeps the coffee at serving temperature after brewing.
- With graduated glass, non-drip tap and fitted with automatic reset.
- The indicator light signals the end of the brewing process and if descaling is needed.



208007

PERCOLATOR

- Single walled stainless steel body.
- Filter pan has built-in filter for coarsely ground coffee, filter paper not needed.
- The percolator keeps the coffee at serving temperature after brewing.
- With graduated glass, non-drip tap and fitted with automatic reset.
- The indicator light signals the end of the brewing process and if descaling is needed.

code	liters	V	W	mm
208007	6	230	1500	340x227x(H)468
208106	10	230	1500	387x275x(H)530
208205	16	230	1500	387x275x(H)595



209882

HOT DRINKS BOILER

- Single-walled.
- Ideal for mulled wine and boiling water for tea.
- Time to boiling: 209882 - 9liter ± 23 min / 209899 - 18 liter ± 52 min.
- Maximum temperature 94-99°C.
- Protected against boiling dry.
- Not suitable for hot chocolate.

code	liters	V	W	mm
209882	9	230	2200	340x227x(H)468
209899	18	230	2200	387x267x(H)595
209905	30	230	2200	500x465x(H)490

With graduated glass



With non-drip tap



Built-in filter for coarsely ground coffee



PERCOLATORS AND HOT DRINKS BOILERS DOUBLE WALLED

- Insulated double-wall polished stainless steel structure reduces heat loss through conduction, convection and radiation.
- Up to 20% lower energy consumption compared to similar single-walled percolators.
- Body and tank made of stainless steel.
- Welded stainless steel handles with silicone grip.

- Anti-drip tap.
- Glass gauge.
- Descaling indicator.
- Dripping tray with stainless steel grid.
- Easy disassembly of parts for cleaning.



211205



211403

PERCOLATOR DOUBLE WALLED

code	liters	V	W	mm
211106	6	230	1500	345x343x(H)517
211205	10	230	1500	386x393x(H)576
211304	16	230	1500	386x393x(H)641

HOT DRINKS BOILER DOUBLE-WALLED

- Thermostatic temperature control adjustable up to 110°C.
- Not suitable for chocolate milk.

code	liters	V	W	mm
211403	9	230	2200	343x345x(H)517
211502	18	230	2200	386x393x(H)641

Double walled - up to 20% lower energy consumption



Built-in filter for coarsely ground coffee



Easily removable dripping tray





GRILL BARBECUE GREEN FIRE

- Much less sensitive to wind thanks to the improved air supply. Easy to clean, due to e.g. fully removable burners and removable Gastronorm 2/1 dripping tray.
- Improved burners grant 90% of the surface useful heat.
- Technical parts mounted out of sight.
- Very clean burning, low CO₂ emissions.
- Removable legs.



149621



149508

GREEN FIRE WITH 2 BURNERS

- Supplied with wind screen.
- Elevated stainless steel grid for keeping warm sauces and finished food.
- Gas hose with quick connector fitting to the barbecue.
- Gas hose and regulator attach to gas bottle - improved portability.

code	-	kW(HS)	mm
149621	2 Stainless steel Gastronorm 1/1 barbecue grids	11.6	740x612x(H)825

GREEN FIRE WITH 2 BURNERS

- Supplied with wind screen.
- Elevated stainless steel grid for keeping warm sauces and finished food.
- Gas hose with quick connector fitting to the barbecue.
- Gas hose and regulator attach to gas bottle - improved portability.

code	-	kW(HS)	mm
149508	Enamelled cast iron Gastronorm 1/1 griddle and grid	11.6	740x615x(H)825





149591

GREEN FIRE WITH 3 BURNERS

- Enamelled cast iron griddle and 2 Gastronorm 1/1 grids included.
- Supplied with wind screen.
- Elevated stainless steel grid for keeping warm sauces and finished food.
- Gas hose with quick connector fitting to the barbecue.
- Gas hose and regulator attach to gas bottle - improved portability.

code	kW[HS]	mm
149591	17.4	1078x612x(H)825



149614

GREEN FIRE WITH 4 BURNERS

- 2 Enamelled cast iron griddles and 2 Gastronorm 1/1 grids included.
- Supplied with wind screen.
- Elevated stainless steel grid for keeping warm sauces and finished food.
- Gas hose with quick connector fitting to the barbecue.
- Gas hose and regulator attach to gas bottle - improved portability.

code	-	kW[HS]	mm
149614	on wheeled base	22	1400x612x(H)825





ribbed side

932001

side with groove



CAST IRON GRIDDLE

- Suitable for all Green Fire Profi Line barbecues.
- Both sides usable, one side smooth, one side ribbed.

code	GN	mm
932001	GN 1/1	325x530



932018

CAST IRON GRID

- Suitable for all Green Fire Profi Line barbecues.

code	GN	mm
932018	GN 1/1	325x530



149522

149539

REAR SHELF FOR GREEN FIRE GRILLS

- For gas grills: 149508, 149621, 149607, 149614.
- Rear shelf 149539 is half the length of a Green Fire 4-burner grill; install 2 full length shelves.

code	mm
149539	650x298x(H)160

SIDE TABLE FOR GREEN FIRE BARBECUES

- Suitable for: 149508, 149591, 149607, 149614, 149621.

code	mm
149522	480x298x(H)160



NEW

932094

GAS HOSE ASSEMBLY GREEN FIRE BARBECUES

- For HENDI Green Fire barbecues 149607 149614 149621 149508 149591.

code
932094



170045

18/0 stainless steel

BARBECUE SKEWERS

code	packed per	mm
170045	24	(L)210



170120

18/0 stainless steel

BARBECUE SKEWERS

code	packed per	mm
170120	6	(L)250
170328	6	(L)350



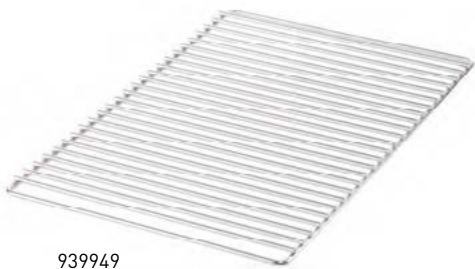

939949



939956



GRID

- Chrome plated grid.
- Suitable for all Green Fire Profi Line barbecues.

code	mm
939949	325x530

FLAME TAMER

- Place the flame tamer over the burner element to prevent fat dripping directly on the burner element.
- Flame tamer made of stainless steel.
- Suitable for all Green Fire Profi Line barbecues.

code	mm
939956	650x530



152706

152805



152904

LAVA ROCKS - FINE

- Suitable for various types of gas barbecues.
- Fine, relatively small rocks.

code	-	weight (kg)
152706	box	3

LAVA ROCKS - COARSE

- Suitable for various types of gas barbecues.
- Coarse, relatively large rocks.

code	-	weight (kg)
152904	bag	9
152805	box	5

DUTCH PANCAKE GRIDDLE

- Suitable for all Green Fire Profi Line barbecues.

code	-
149553	GN 2/1



149553





700051

GAS BARBECUE 'EUROPA'

- The Europa 3 has excellent cooking properties. The high temperature sears meat evenly and quickly, reducing adhesion to the grid even when the grid hasn't been greased.
- The three, separately adjustable, lengthwise burners have thermocouple security and electronic ignition.
- The Europa 3 has a completely black epoxy coated frame with four wheels, two of which are caster wheels, and a secure gas bottle holder.
- Grease which is drained from meat during cooking is led through a special channel to a grease collector.
- Thanks to the deep gas bottle holder you can place the gas bottle safely under the barbecue.
- The Europa 3 is supplied complete with lava rocks and a roasting pan.
- Griddle surface: 1100 x 500 mm.

code	kW[HS]	mm
700051	21.6	1260x580x(H)900



700105

GAS BARBECUE ATLANTA

- The Atlanta has excellent cooking properties due to the optimal heat distribution and hot air circulation inside the burner enclosure. The high temperature sears meat evenly and quickly, reducing adhesion to the grid even when the grid hasn't been greased.
- The 3 separately adjustable transverse burners have thermocouple security and electronic ignition.
- The burner assembly is made entirely of stainless steel and the grids are removable for easy cleaning.
- The three burners also allow the surface to be divided in separate heat zones for simultaneous cooking of meat, vegetables & fish.
- The Atlanta has a completely black epoxy coated frame with four caster wheels and a secure gas bottle holder.
- Thanks to the deep gas bottle holder you can place the gas bottle safely under the barbecue.
- Griddle surface: 1100 x 500 mm.

code	kW[HS]	mm
700105	13	1285x770x(H)917



700044

TAMPA GAS GRILL

- The Tampa has excellent cooking properties due to the optimal heat distribution and hot air circulation inside the burner enclosure.
- The high temperature sears meat evenly and quickly, reducing adhesion to the grid even when the grid hasn't been greased.
- The burner assembly is made entirely of stainless steel and can be completely disassembled for easy cleaning.
- The single lengthwise burner is adjustable, has thermocouple security and piezo ignition.
- The Tampa has a completely black epoxy coated frame with four wheels, two of which are caster wheels, and a secure gas bottle holder.
- Grease which is drained from meat during cooking is led through a special channel to a grease collector.
- Thanks to the deep gas bottle holder you can place the gas bottle safely under the barbecue.
- Griddle surface: 1022 x 500 mm.

code	kW[HS]	mm
700044	10	1260x580x(H)900



FIESTA



146002



Burner unit can be removed for easy cleaning



146804

FIESTA 600

- Stainless steel base and sheet steel paella pan Ø 600 mm.
- Includes gas hose, electronic ignition and pressure regulator.
- With thermocouple and a round burner.
- Burner unit can be removed for easy cleaning.
- The space underneath is suitable for gas cylinders of 5 or 6 kg.
- Suitable for propane gas, consumption 334 g/h.

code	kW(HS)	mm
146002	4.8	600x600x(H)870

FIESTA 800

- Stainless steel base and sheet steel paella pan Ø 800 mm.
- Includes gas hose, electronic ignition and pressure regulator.
- With thermocouple and a round burner.
- Burner unit can be removed for easy cleaning.
- The space underneath is suitable for gas cylinders of 5 or 11 kg.
- Suitable for propane gas, consumption 489 g/h.

code	kW(HS)	mm
146804	7	800x800x(H)900



622407

PAELLA PAN

- Top-quality frying pans made of sheet steel.
- With 2 handles.

code	Suitable for Fiesta gas grill	mm
622100		ø340x(H)40
622308		ø460x(H)40
622407	146002	ø600x(H)40
622605	146804	ø800x(H)50

BARBECUE APRON

- Canvas 280 g/m².
- Flame retardant coating.

code	mm
556696	810x660



556696



BAKE- & GRILL-MASTER



154601

BAKE-MASTER MINI

- Frame made of 18/0 stainless steel.
- With enamelled frying pan.
- Inner dimensions of frying pan 290x480x(H)55 mm.
- Electronic ignition and thermocouple.
- Gas hose and pressure regulator included.
- Suitable for propane and butane gas.
- Consumption 0,215 m³/h.

code	kW[HS]	mm
154601	5.8	340x540x(H)300



154618

BAKE-MASTER MAXI

- Frame made of 18/0 stainless steel.
- With enamelled frying pan.
- Inner dimensions of frying pan 590x480x(H)55 mm.
- Electronic ignition and thermocouple.
- Gas hose and pressure regulator included.
- Suitable for propane and butane gas.
- Consumption 0,430 m³/h.

code	kW[HS]	mm
154618	11.6	650x540x(H)300



154700

Enamelled
frying pan
included

GRILL-MASTER MINI

- Frame made of 18/0 stainless steel.
- With chrome plated grid and enamelled frying pan.
- Inner dimensions of frying pan 290x480x(H)55 mm.
- Electronic ignition and thermocouple.
- Gas hose and pressure regulator included.
- Suitable for propane and butane gas.
- Consumption 0,215 m³/h.

code	kW[HS]	mm
154700	5.8	340x540x(H)840



154717



GRILL-MASTER MAXI

- Frame made of 18/0 stainless steel.
- With chrome plated grid and enamelled frying pan.
- Inner dimensions of frying pan 590x480x(H)55 mm.
- Electronic ignition and thermocouple.
- Gas hose and pressure regulator included.
- Suitable for propane and butane gas.
- Consumption 0,430 m³/h.

code	kW[HS]	mm
154717	11.6	650x540x(H)840





ROAST-MASTER MAXI

- With chrome plated grid and heavy duty flame tamer.
- Frame and flame tamer made of 18/0 stainless steel.
- Electronic ignition and thermocouple.
- Gas hose and pressure regulator included.
- Suitable for propane or butane gas.
- Consumption 0,430 m³/h.

code	kW[HS]	mm
154878	11.6	650x540x(H)840



154878



144923

PROTECTIVE COVER

- Made of UV-resistant PEVA.

code	-	mm
144923	Grill- / Roast- Master Maxi 154717 154878	720x560x(H)360



154540



154908



ROAST-MASTER MAXI 50 50

- Frame made of 18/0 stainless steel.
- With chrome plated grid and enamelled frying pan.
- Inner dimensions of frying pan 290x480x(H)55 mm.
- Electronic ignition and thermocouple.
- Gas hose and pressure regulator included.
- Suitable for propane and butane gas.
- Consumption 0,430 m³/h.

code	kW[HS]	mm
154540	11.6	650x540x(H)840



GRILL-MASTER QUATTRO

- Fully stainless steel frame with 2 dripping trays.
- Suitable for propane and butane gas and fitted with 4 burners which can be regulated independently.
- Supplied with 2 nickel-plated grids and 1 enamelled griddle (590x480x(H)55 mm internal dimensions).
- Thermocouple and electronic ignition.
- Gas hose and pressure regulator included.
- Consumption 0,8 m³/h.
- On a base with bottom shelf and 4 wheels for easy moving.

code	kW[HS]	mm
154908	22	1330x600x(H)920



NEW

154632

GRID FOR GRILL MASTER

- For HENDI Grill-master barbecues 154717 154878 154908.

code

154632

NEW

154663

GRID FOR GRILL-MASTER MINI

- Grid made from stainless steel for HENDI Grill-Master Mini 154700

code

154663

mm

540x340

NEW

148723

TOP GRID FOR XANTOS BARBECUE

- For HENDI Xantos barbecue 148624

code

148723

NEW

154687

BAKING TRAY ENAMELLED FOR BAKE & GRILL-MASTER MINI

- For HENDI Bake- & Grill-master mini barbecues 154601 154700.

code

154687

NEW

152157

PRESSURE REGULATOR 50 MBAR FOR GAS BARBECUE PROPANE/BUTANE

- For HENDI gas barbecues & Hokkers.

code

152157

NEW

152188

PRESSURE REGULATOR 37MBAR- Pressure regulator 37mBar BE uni with pillar and hose clamp.
- For use with barbecues and patio heaters.

code

152188

NEW

145678

GAS REGULATOR WITH RUBBER SEAL BAKE-, GRILL- & ROAST-MASTER

- For HENDI Bake-, Grill- & Roast-master barbecues 154908 154502 154601 154618 154700 154717.

code

145678

NEW

145753

GAS HOSE ASSEMBLY BAKE-, GRILL- & ROAST-MASTER

- For HENDI Bake-, Grill- & Roast-master barbecues 154908 154502 154601 154618 154700 154717.

code

145753



NEW

155028

GRID FOR ROAST MASTER 50/50

- Made from chrome plated steel.

code	mm
155028	477x300

NEW

154885

TOP GRID FOR ROAST-MASTER

- For HENDI Roast-master barbecues 154878.

code	mm
154885	

NEW

154632

GRID FOR GRILL MASTER

- For HENDI Grill-master barbecues 154717 154878 154908.

code	mm
154632	

ENAMELLED FRYING PAN

- Inner dimensions: 590x480 mm.

code	mm
154656	700x520x(H)55



154656

**XENON PRO**

- This stainless steel power grill with folding base is easy to move thanks to its wheels and can be flat-packed into a compact unit during transport.
- The burner develops a high temperature in the windproof unit and therefore this barbecue is suitable for high volume production.
- The unit itself is easy to clean thanks to these high temperatures.
- The grill is fitted with a thermocouple and electronic ignition, gas hose and pressure regulator are included.
- Suitable for propane gas.
- Grid surface area 860x260 mm (2 grids of 430x260 mm).
- Folding and mobile base.
- Gas hose, electronic ignition and pressure regulator included.
- Consumption 536 g/h.

code	kW[HS]	mm
148105	7.5	1120x410x(H)900



148105

**GAS HOSE ASSEMBLY XENON PRO & FIESTA BARBECUES**

- For HENDI Xenon Pro 148105.
- For HENDI Hokker Profi Line 147108.

code
152171

**NEW**

CHARCOAL BARBECUES

- 18/0 stainless steel with removable stands.



150603



150801

CHARCOAL BARBECUE PATIO

- Fitted with 2 grids of 345x345 mm each.
- Inside dimensions basin: 710x350x(H)max110 mm.
- Double bottom for ash collection.

code	mm
150603	770x380x(H)760

CHARCOAL BARBECUE RESTO

- Fitted with 3 grids of 345x345 mm each.
- Inside dimensions basin: 1070x350x(H)max110 mm.
- Double bottom for ash collection.

code	mm
150801	1145x380x(H)770



NEW

TOP GRID FOR CHARCOAL BARBECUES

- Fits HENDI charcoal barbecues 150603 150801.

code
151617



151617

NEW

CHARCOAL MARABU

- For barbecuing meat, fish, seafood, vegetables and appetizers.
- Produced by carbonisation of hardwood at temperatures between 400 and 700°C, without air.
- Made from the invasive marabou plant that grows in Cuba - perfect raw material for environmentally and socially responsible production.
- 100% natural.
- Releases a smoky aroma during burning which gives food a unique flavour.
- High calorie content, low spark level.
- Twice the burning time compared to commonly used soft charcoal types.

code	weight (kg)
199541	10



199541



BIG CHUNKS

- Intended for medium to high temperatures
- Ideal for pizza ovens, outdoor ovens and barbecues - direct to charcoal
- Unique aroma
- Strengthen the taste of your favourite dishes
- Made from the best wood or from the best aging barrels.
- Our offer includes wood chunks made from:
 - wine, whisky, or cognac barrels.
 - beech, olive, citrus, almond, or peach wood.

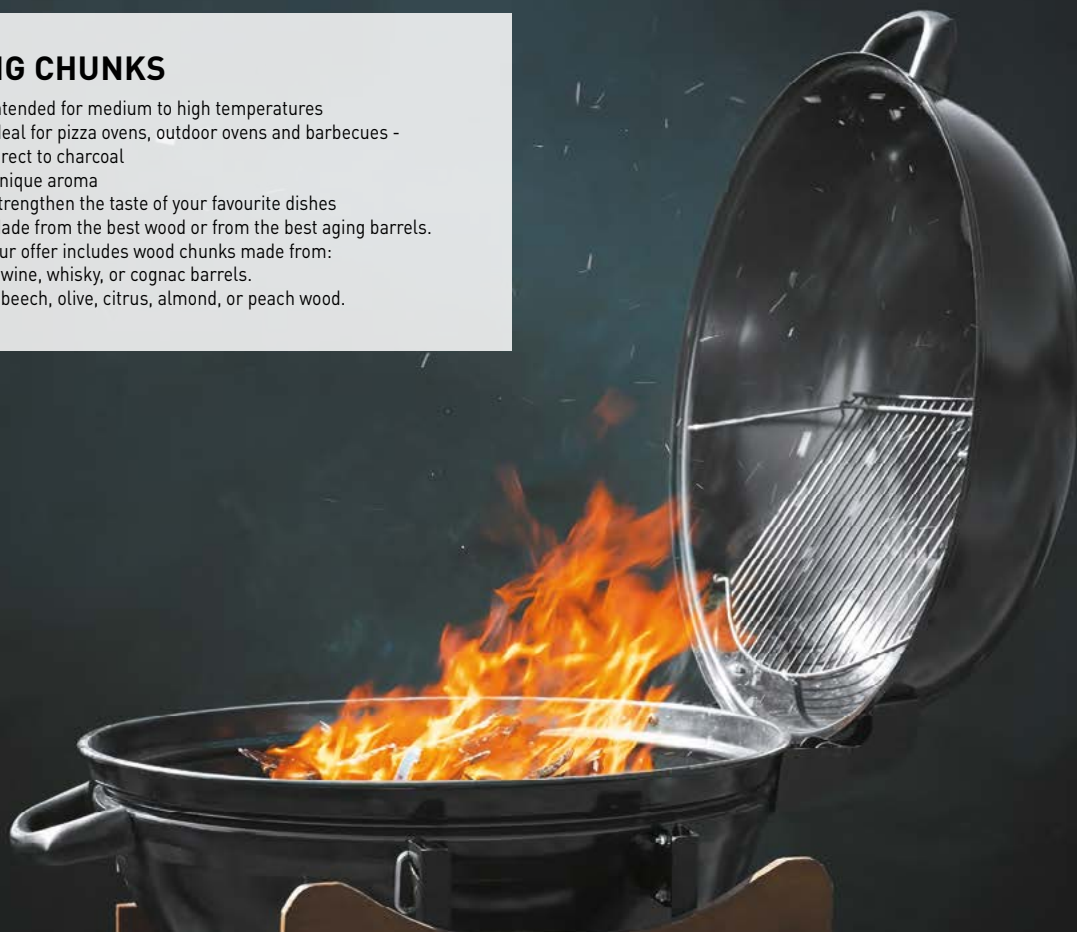

PEACH

code 199503

weight 3 kg



BEECH

code 199459

weight 3 kg



CITRUS

code 199480

weight 3 kg



OAK

code 199466

weight 3 kg



ALMOND

code 199497

weight 3 kg



OLIVE

code 199473

weight 3 kg



RED WINE

code 199510

weight 3 kg



COGNAC

code 199534

weight 3 kg



WHISKY

code 199527

weight 3 kg





556603

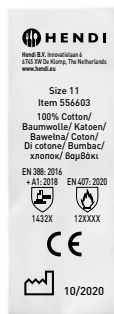

OVEN MITTS, COTTON - 2 PCS

code	packed per	mm
556603	2	(L)350



556627

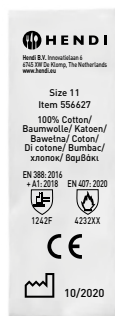

OVEN MITTS, FIBERGLASS - 2 PCS

code	packed per	mm
556627	2	(L)360



556634

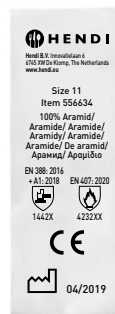

OVEN GLOVE HEAT RESISTANT - 2 PCS

- Heat resistant up to 250°C.
- Comfortable fit.

code	packed per	mm
556634	2	(L)300



556610

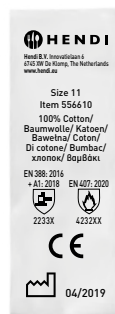

OVEN MITTS, FLAME RETARDANT COTTON - 2 PCS

- Extra long to protect the forearm.
- 2 pcs.

code	packed per	mm
556610	2	(L)380





525524

525531

525555

WIRE BRUSH SET NARROW - 3 PCS

- Set of 3 different narrow wire brushes.
- Consists of one brush with stainless steel bristles, one with brass bristles and one with nylon bristles.

code	packed per	mm
525524	3	(L)178
525531	3	(L)230

BRASS & STAINLESS STEEL WIRE BRUSH SET - 2 PCS

- Set of 2 different wire brushes with 4 rows of 14 bristles.
- Consists of one brush with stainless steel bristles and one with brass bristles.

code	packed per	mm
525555	2	(L)290



525548



WIRE BRUSH

- Polypropylene with 8 rows of 8 stainless steel wire bristles.
- With steel scraper and long handle.

code	mm
525548	70x310x(H)85



525425

525432



WIRE BRUSH Y-SHAPED

- Stainless steel wires, with comfortable handle fitted with a loop.

code	mm
525425	310x170
525432	520x170



525562

WIRE BRUSH

- Comfortable black plastic handle with steel bristles.

code	mm
525562	150x55

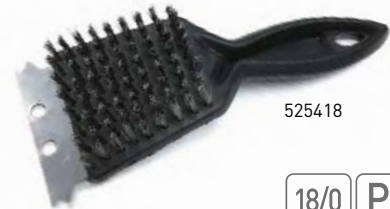

525418



WIRE BRUSH

- Polypropylene with 8 rows of 9 stainless steel wire bristles.
- Steel scraper for grids.

code	mm
525418	70x200x(H)80



525517



WIRE BRUSH - 2 PCS

- Wood with 4 rows of 14 steel wire bristles.

code	packed per	mm
525517	2	(L)290



855218

855201



GRIDDLE SCRAPER

code	mm
855201	100x320
855218	Spare blade for 855201 - 10 pieces

PATIO HEATER



272602

Protective cover
- to be ordered
separately

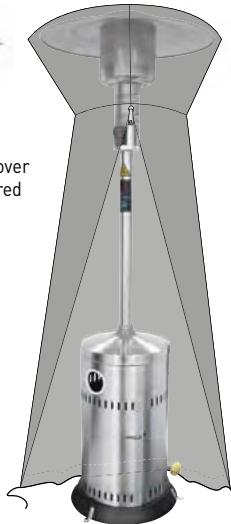

144916



Easy to transport thanks to
its 2 wheels



Including electronic ignition, gas
hose and pressure regulator



272701

Height-
adjustable
heater -
model 272701

PATIO HEATER

- Lamp for restaurant terraces.
- It can accommodate a 12 "gas cylinder with 11 kg capacity.
- Easy to transport thanks to its 2 wheels.
- Including electronic ignition, gas hose and pressure regulator.
- With anti-tilt protection.
- Weight: 18,8 kg.

code	kW	mm
272602	12.5	ø770x(H)2200
144916	Protective cover	ø790x(H)2220

PATIO HEATER - RETRACTABLE

- Suitable for propane or butane gas.
- Easy to transport thanks to the 2 wheels.
- Retractable shaft to facilitate transport and storage.
- Including electronic ignition, gas hose and pressure regulator.
- With anti-tilt protection.
- Retractable to (H)160 cm for storage and transport purposes.
- Weight: 16,5 kg.

code	kW	mm
272701	12.5	ø770x(H)1580
144916	Protective cover	ø790x(H)2220



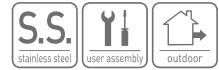
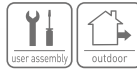

Protective cover
- to be ordered
separately



144909

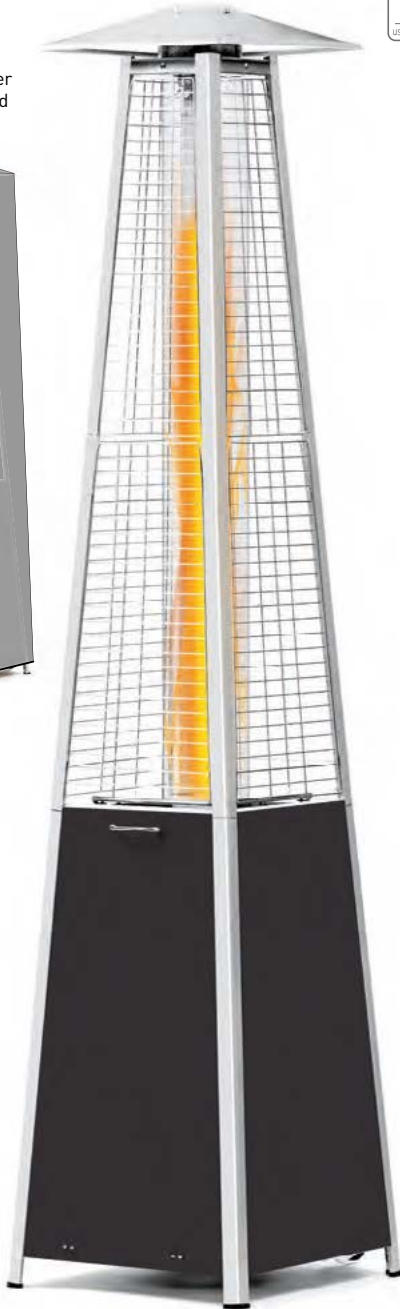

272404

Protective cover
- to be ordered
separately

144954

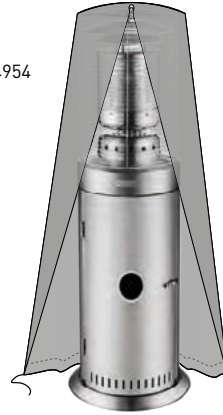

272275

GAS HOSE ASSEMBLY PATIO HEATERS

- For HENDI Patio heaters 272602
272701 272404.

code

272275



152188

PRESSURE REGULATOR 37MBAR

- Pressure regulator 37mBar BE
uni with pillar and hose clamp.
- For use with barbecues and
patio heaters.

code

152188



272411

PATIO HEATER PYRAMID

- Heating with a real flame in a glass tube, improves ambiance.
- Aluminium structure with black metal side panels and quartz glass tube.
- Gas tank fits in the base.
- Includes electronic ignition, gas hose and pressure regulator.
- With anti-tilt protection.
- Suitable for propane or butane gas.
- Weight: 22,6 kg.

code	kW	mm
272404	11.2	500x500x(H)2220
144909	Protective cover	480x480x(H)2220

LOUNGE HEATER

- Suitable for propane or butane gas, max. 15 liter gas bottles.
- Compact design with hinged door for easily replacing the gas bottle.
- With tilt switch, flame failure device and flame guard for enhanced safety.
- Including electronic ignition, gas hose and pressure regulator.
- Easy to transport thanks to the 2 wheels.
- Weight: 14 kg.

code	kW	mm
272411	8.5	ø556x(H)1430
144954	Protective cover	ø580x(H)1460





272428

BOLA PATIO INFRARED RADIANT HEATER

- Suitable for heating and warming up patios on cold days.
- Powerful - will keep your guests comfortable even when the temperature is low.
- Designed for wall mounting, it can heat an area from about 16 to 32 m².
- The heating lamp uses modern carbon fiber, which translates into longer life and high heating efficiency with low energy consumption.
- Robust housing with protective grid made of heat-resistant aluminium.
- Supplied with remote control for easy adjustment of settings.
- You can choose between 4 heating power levels.
- With built-in timer for up to 25 hours.



code	V	W	mm
272428	230	2500	879x85x(H)195

TRIPOD FOR INFRARED PATIO HEATER

- For use with Bola infrared patio heater 272428.

code	mm
270349	364x495x(H)601



TORNADO INFRARED RADIANT HEATER

- Suitable for heating and warming up both indoor and outdoor areas.
- Powerful - will keep your guests comfortable even when the temperature is low.
- Free-standing, with a stable base, it can heat an area from about 16 to 32 m².
- The heating lamp uses modern carbon fiber, which translates into longer life and high heating efficiency with low energy consumption.
- Robust housing with protective grid made of heat-resistant aluminium.
- Supplied with remote control for easy adjustment of settings.
- LED display indicating the current heating level.
- You can choose between 2 heating power levels.
- With built-in timer for up to 25 hours.

code	V	W	mm
272435	230	2000	130x90x(H)900



272435



GENERAL INFORMATION

This product is protected by copyright. Use for commercial activities is only allowed if the original context is left intact, unless explicit permission for adaptation is given in writing by the author. In all cases of (partial) reproduction HENDI BV is to be clearly credited as source. Because of our striving for continuous product development, we reserve the right to change a product's specification, price and appearance without prior warning. Printing and typesetting errors reserved. The printed colors of products in this catalogue may have a limited deviation from the physical product.

For more information see www.hendi.eu



	Energy saving product		Food Contact compliant		High density polyethylene
	HACCP compliant		Not Food Contact compliant		Low density polyethylene
NEW	New product		Cooling		Polypropylene
	For indoor and outdoor use		Self-assembly		Expanded Polypropylene
	For indoor use only		Temperature resistance		Polycarbonate
	For outdoor use only		Temperature resistance range		ABS plastic
	Suitable for gas stoves		Aluminium		POM plastic
	Suitable for gas stoves only		Aluminium casting		Polyamide
	Suitable for electric stoves		Stainless steel		SAN plastic
	Suitable for ceramic stoves		Stainless steel 18/0		Hard polymer heat resistant
	Suitable for induction stoves		Stainless steel 18/8		Silicone
	Not suitable for induction stoves		Stainless steel 18/10		Plexiglas
	Microwave proof		German steel X50CrMoV15		BPA free – no Bisphenol A
	Not microwave proof		Carbon steel		Fibreglass
	Dishwasher proof		Tin plated		Melamine
	Not dishwasher proof		Chrome plated		Porcelain
	Suitable for use in ovens		Nickel plated		Non slip
	Stackable		Polyethylene		Magnetic

