



deKora

Professional
**Cake
Design**
2024

dekora.es



QUEREMOS
Convertir **las**
celebraciones
en **momentos**
INOLVIDABLES y
Divertidos

deKora

DISCOS Y PLACAS

Discs and plaques · Disques et plaques · Discos e placas · Dischi e placche3

Discos y placas comestibles

Edible discs and plaques · Disques et plaques comestibles · Discos e placas comestíveis · Dischi e placche commestibili..... 4

Discos y placas de oblea

Wafer discs and plaques · Disques et plaques en azyne · Discos e placas de obreia · Dischi e placche in cialda..... 29

OBLEA

Wafer · Azyne · Obreia · Cialda55

AZÚCAR & JELLY

Sugar & jelly · Sucre et jelly · Açucar e jelly · Zucchero e jelly..... 77

TOPPING

Topping decoration · Décoration topping · Decoração topping
Decorazione topping..... 109

CHOCOLATE

Chocolate decoration · Décoration chocolat · Decoração chocolate
Cioccolato 119

MATERIA PRIMA Y TEXTURIZANTES

Raw materials and texturizers · Matière première et épaississants · Matéria
prima e texturas · Materia prima e testurizzanti..... 145

COLORANTES

Colourings · Colorants · Colorantes · Coloranti..... 169

DECORACIÓN NO COMESTIBLE

Non edible decoration · Décoration non comestible · Decoração não
comestível · Decorazione non commestibile 191

CAKE TOPPERS 225

VELAS + BENGALAS

Candles + Sparkles · Bougies + Bougies fontaines · Velas + foguetes · Cande
le + Bengala 237

EVENTOS

Events · Évènements · Eventos · Eventi..... 281

Boda

Weddings · Mariage · Boda · Nozze 282

Bautizo

Christening · Baptême · Baptizado · Battesimo 302

Comunión

Holy Communion · Communion · Comunhão · Comunione..... 312

UTILLAJE

Tools · Outillage · Utensílios · Utensili 321

EXPOSITORES - TRADE MARKETING

Stands · Présentoirs · Expositores · Espositori..... 401



Nuestros indicadores

Our indicators / Nos indicateurs / Nossos indicadores / I nostri indicatori



Sin gluten · Gluten free · Sans gluten
Sem glúten · Senza glutine.



Colorantes naturales · Natural colors
Colorants naturels · Corantes naturais
Coloranti naturali.



Sin E-171 · E-171 Free · Sans E-171
Sem E-171 · Senza E-171.



Aroma y color natural
Natural flavour - natural colour
Arôme naturel - couleur naturelle
Aroma natural - cor natural
Aroma naturale - colore naturale



Producto apto para vegetarianos
Product suitable for vegetarians
Produit adapté aux végétariens
Produto adequado para vegetarianos
Prodotto adatto ai vegetariani



Sin proteínas de la leche
Without milk proteins
Sans protéines de lait
Sem proteínas do leite
Senza proteine del latte



Sin lactosa · Lactose free · Sans lactose
lactose · Sem lactose · Senza lattosio



Incluye receta · Includes recipe
Inclut la recette · Includi receita
Include la ricetta



Sin azúcares añadidos
No added sugar
Sans sucre ajouté
Sem adição de açúcar
Senza zuccheri aggiunti



YouTube

Producto que incluye Vídeo · Product that includes Video · Produit qui inclut la vidéo · Produto que inclui Vídeo
Prodotto che include Video



Producto reutilizable · Product reusable · Produit réutilisable
Produto reutilizável · Prodotto riutilizzabile



Chocolate 100%
Chocolat 100%
Cioccolato 100%



AZO Free



Moldes magnéticos · Magnetic moulds
Moules magnétiques · Moldes magnéticos · Stampi magnetici



Sin colorantes azoicos · Free of azo dyes · Sans colorants azoïques · Sem corantes azóicos · Senza coloranti azoici



Producto apto para la venta retail
Product suitable for retail sale
Produit adapté à la vente au détail
Produto apto para venda por retail
Prodotto idoneo alla vendita retail



Apto para contacto alimentario
Suitable for food contact
Adapté au contact alimentaire
Adequado para contato alimentar
Idoneo al contatto con alimenti



Producto Halal · Halal product
Produit Halal · Produto Halal
Prodotto Halal



Producto Kosher · Kosher product
Produit Casher · Produto Kosher
Prodotto Kosher



La mayoría de nuestras figuras contienen envasado individual.
Most of our figures come individually packaged.



La plupart de nos figures sont emballées individuellement.



A maioria das nossas figuras são embaladas individualmente.
La maggior parte delle nostre figure prevedono imballaggio individuale.



deKora



DISCOS Y PLACAS COMESTIBLES

Edible discs and plaques · Disques et plaques comestibles
Discos e placas comestíveis · Dischi e placche commestibili

PAPEL COMESTIBLE

Edible paper · Papier comestible · Papel comestível · Carta edibile

Todos nuestros discos comestibles, mini discos y recortables son fabricados sin azúcar ni colorante E171.

All our edible discs, mini discs and cut-outs are made sugar and colorant E171 free.

Tous nos disques, mini disques et découpables sont fabriqués sans sucre ni colorant E171.

Todos os nossos discos, mini discos e recortáveis são fabricados sem açúcar e corante E171.

I nostri dischi edibili da 16 cm, mini dischi e tagliabili non contengono né zucchero né colorante E171.



Ø 20 cm



236018
UNICORNIO



236044
PEPPA PIG



NEW
236008
FROZEN



236037
DISNEY PRINCESS



231272
MICKEY



236017
PAW PATROL



236039
EL REY LEÓN



236028
DINOSAURIO



236040
SPIDER-MAN



236038
AVENGERS



231137
FÚTBOL

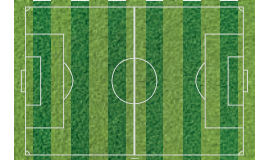

231136
FÚTBOL

Ø 16 cm



231347
FROZEN



231360
UNICORNIO



231357
PAW PATROL



231367
DINOSAUR



231359
FOOTBALL



231362
SPIDER-MAN



231365
AVENGERS

Ø 15,5 cm



231393
SPIDER-MAN



231392
AVENGERS



NEW
231410
FOOTBALL



231394
PAW PATROL



231403
MICKEY



231407
HAPPY BIRTHDAY



231390
PEPPA PIG



231389
MINNIE



231387
TESIA & FRIENDS



231408
FROZEN



231388
PRINCESAS

PAPEL COMESTIBLE

Edible paper · Papier comestible · Papel comestível · Carta edibile

ø 5,8 cm



236101
MR WONDERFUL



236033
PEPPA PIG



236049
MICKEY Y MINNIE



236032
PAW PATROL

ø 3,4 cm



231400
PAW PATROL



231402
DINOSAURIOS



231401
TESIA & FRIENDS

Recortables

Cuts-outs - Découpables - Recottáveis - Carta edibile



231399
PEPPA PIG



231395
PAW PATROL



231396
FROZEN



NEW **231411**
BARBIE



231397
AVENGERS



231398
SPIDER-MAN

Rectangular 21 x 14,85 cm

Rectangular - Rectangulaire - Retangular - Rettangolare

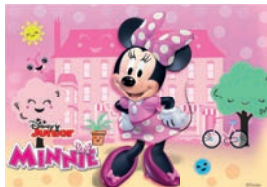

236069
MINNIE



236063
PAW PATROL



236084
DISNEY PRINCESS

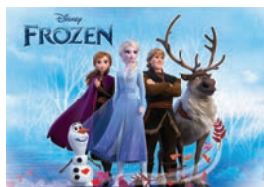

236054
FROZEN



236076
SPIDERMAN

PAPEL COMESTIBLE



Edible paper · Papier comestible · Papel comestível · Carta edibile

Ø 20 cm

236018

UNICORNIO



Unicorn - Licorne - Unicórnio

Ø 20 cm ·  x 6 



236044

PEPPA PIG

Ø 20 cm ·  x 6 





PAPEL COMESTIBLE

Edible paper · Papier comestible · Papel comestível · Carta edibile



NEW

236008
FROZEN ZERO

Ø 20 cm ·  x 6 



236037
PRINCESAS DISNEY



Ø 20 cm ·  x 6 



PAPEL COMESTIBLE



Edible paper · Papier comestible · Papel comestível · Carta edibile

231272
MICKEY

Ø 20 cm ·  x 6 



236017
PAW PATROL

Ø 20 cm ·  x 6 



PAPEL COMESTIBLE

Edible paper · Papier comestible · Papel comestível · Carta edibile

236039

EL REY LEÓN

Ø 20 cm ·  x 6



236028

DINOSAURIO

Dinosaur - Dinsaure

Dinossaurio

Ø 20 cm ·  x 6



PAPEL COMESTIBLE

Edible paper · Papier comestible · Papel comestível · Carta edibile

236040

SPIDER-MAN

Ø 20 cm ·  x 6



236038

AVENGERS

Ø 20 cm ·  x 6





PAPEL COMESTIBLE

Edible paper · Papier comestible · Papel comestível · Carta edibile

231137

FÚTBOL

Football - Futebol



Ø 20 cm ·  x 6 



231136

FÚTBOL

Football - Futebol

20 x 30 cm ·  x 6 

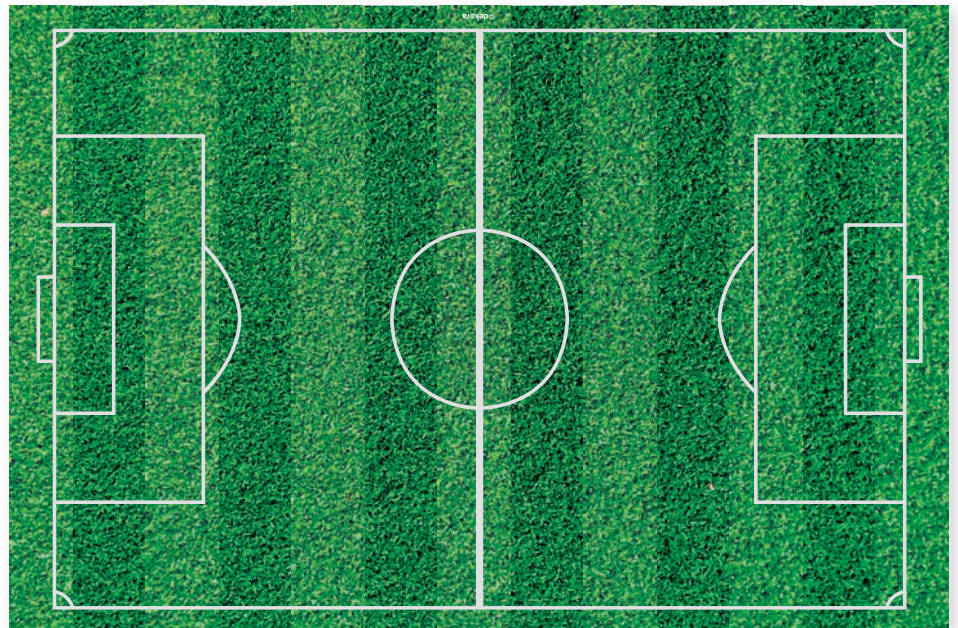



PAPEL COMESTIBLE

Edible paper · Papier comestible · Papel comestível · Carta edibile

Ø 16 cm





231347
FROZEN
15 g · Ø 16 cm

 x 10 



231360
UNICORN
15 g · Ø 16 cm

 x 10 



PAPEL COMESTIBLE

Edible paper · Papier comestible · Papel comestível · Carta edibile



231357
PAW PATROL
15 g · Ø 16 cm

10 x 16 cm



231367
DINOSAUR
15 g · Ø 16 cm

10 x 16 cm



231359
FOOTBALL
15 g · Ø 16 cm

10 x 16 cm



PAPEL COMESTIBLE

Edible paper · Papier comestible · Papel comestível · Carta edibile



231362
SPIDER-MAN
15 g · Ø 16 cm
x 10



231365
AVENGERS
15 g · Ø 16 cm
x 10



PAPEL COMESTIBLE

Edible paper · Papier comestible · Papel comestível · Carta edibile

Ø 15,5 cm



231393
SPIDER-MAN
14 g · Ø 15,5 cm

📦 x 10 📄



231392
AVENGERS
14 g · Ø 15,5 cm

📦 x 10 📄



NEW
231410
FÚTBOL ZERO
14 g · Ø 15,5 cm

📦 x 10 📄



PAPEL COMESTIBLE

Edible paper · Papier comestible · Papel comestível · Carta edibile



231394
PAW PATROL
 14 g · Ø 15,5 cm
 x 10



231403
MICKEY
 14 g · Ø 15,5 cm
 x 10



231407
HAPPY BIRTHDAY
 14 g · Ø 15,5 cm
 x 10



PAPEL COMESTIBLE

Edible paper · Papier comestible · Papel comestível · Carta edibile



231390

PEPPA PIG

14 g · Ø 15,5 cm

14 x 10



231389

MINNIE

14 g · Ø 15,5 cm

14 x 10



231387

TESIA & FRIENDS

14 g · Ø 15,5 cm

14 x 10



PAPEL COMESTIBLE

Edible paper · Papier comestible · Papel comestível · Carta edibile



231408
FROZEN
14 g · Ø 15,5 cm
x 10



231388
PRINCESAS
14 g · Ø 15,5 cm
x 10



PAPEL COMESTIBLE

Edible paper · Papier comestible · Papel comestível · Carta edibile

Mini discos COMESTIBLES 5,8 cm.

Mini edible discs - Mini disques comestible - Mini discos comestíveis - Mini dischi edibili



TROQUELADOS – DIE CUTS – DÉCOUPE

236101

MR WONDERFUL

Ø 5,8 cm ·  x 6  x 6 



Youtube

TROQUELADOS – DIE CUTS – DÉCOUPE

236033

PEPPA PIG

Ø 5,8 cm ·  x 6  x 6 



PAPEL COMESTIBLE

Edible paper · Papier comestible · Papel comestível · Carta edibile



27 cm



27 cm

17 cm

2 cm

16 cm

TROQUELADOS – DIE CUTS – DÉCOUPE

236049

MICKEY & MINNIE

Ø 5,8 cm · x 6 x 6



27 cm

17 cm

2 cm

TROQUELADOS – DIE CUTS – DÉCOUPE

236032

PAW PATROL

Ø 5,8 cm · x 6 x 6



PAPEL COMESTIBLE

Edible paper · Papier comestible · Papel comestível · Carta edibile

Mini discos COMESTIBLES 3,4 cm.

Mini edible discs - Mini disques comestible - Mini discos comestíveis

Mini dischi edibili



27 cm

231400
PAW PATROL

Ø 3,4 cm

6 x 6 x 20 DISK



16 cm



231402
DINOSAURIOS

Ø 3,4 cm

6 x 6 x 20 DISK



27 cm

17 cm

2 cm

PAPEL COMESTIBLE

Edible paper · Papier comestible · Papel comestível · Carta edibile



231401 TESIA & FRIENDS

Ø 3,4 cm · x 6 x 20 



Recortables

Cuts-outs - Découpables - Recottáveis - Carta edibile



231399
PEPPA PIG
 14,8 x 21 cm
 x 6 x 13 u.



231395
PAW PATROL
 14,8 x 21 cm
 x 6 x 15 u.



PAPEL COMESTIBLE

Edible paper · Papier comestible · Papel comestível · Carta edibile



231396
FROZEN

14,8 x 21 cm

☞ x 6 ☞ x 12 u.



NEW

231411
BARBIE

14,8 x 21 cm

☞ x 6 ☞ x 12 u.



PAPEL COMESTIBLE

Edible paper · Papier comestible · Papel comestível · Carta edibile



231397
AVENGERS
 14,8 x 21 cm
 x 6 x 13 u.



231398
SPIDER-MAN
 14,8 x 21 cm
 x 6 x 12 u.



PAPEL COMESTIBLE

Edible paper · Papier comestible · Papel comestível · Carta edibile



Rectangular

Rectangular - Rectangulaire - Retangular - Rettangolare



236069

MINNIE

14,8 x 21 cm ·  x 6 





©Disney



236063

PAW PATROL

14,8 x 21 cm ·  x 6 





©&TM Spin Master Ltd.

PAPEL COMESTIBLE

Edible paper · Papier comestible · Papel comestível · Carta edibile





236084
DISNEY PRINCESS

14,8 x 21 cm ·  x 6 



236054
FROZEN

14,8 x 21 cm ·  x 6 





PAPEL COMESTIBLE

Edible paper · Papier comestible · Papel comestível · Carta edibile



236076
SPIDERMAN

14,8 x 21 cm ·  x 6 



deKora



DISCOS Y PLACAS DE OBLEA

Wafer discs and plaques · Disques et plaques en azyme
Discos e placas de obreia · Dischi e placche in cialda

Ø 20 cm

Wafer discs + Foil - Disques azyme + Foil - Discos obreia + Foil



114398
SPIDER-MAN



114367
SPIDER-MAN



114402
AVENGERS



114401
AVENGERS



160137
JUSTICE LEAGUE



NEW **160156**
TORTUGAS NINJA



160183
MR WONDERFUL



160160
BOB ESPONJA



114378
MICKEY



160132
PJ MASKS



160117
PAW PATROL



160129
PAW PATROL



114370
CARS III



145093
DINOSAURIO



NEW **160190**
BARBIE



NEW **160186**
WONDER WOMAN



114382
FROZEN



114383
FROZEN



114366
FROZEN



114377
PRINCESAS



160163
PAW PATROL



160131
PEPPA PIG



114371
MINNIE



114381
MINNIE



160174
MY LITTLE PONY



145099
SIRENITA



145096
UNICORNIO



145086
UNICORNIO



NEW **145114**
FÚTBOL



145094
FÚTBOL

OBLEA

Wafer · Azyme · Obreia · Cialda

Ø 3,4 cm

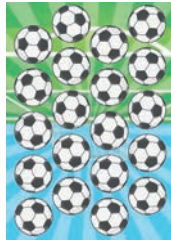

145102

MINI BALONES FÚTBOL



145109

MINI BABY SHOWER BOY



145108

MINI BABY SHOWER GIRL

Siluetas de oblea

Wafer silhouette - Silhouette de azyme - Silhueta obreia - Sagome in cialda

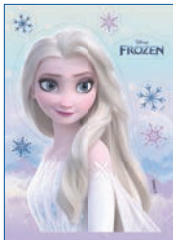

114412
FROZEN



160182
PEPPA PIG

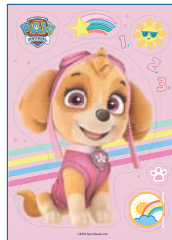

160181
PAW PATROL - SKYE



160167
PAW PATROL - CHASE



114418
MICKEY



114419
MINNIE

Dekorapin de oblea

Wafer Dekorapin - Dekorapin azyme - Dekorapin obreia - Dekorapin cialda



135050
PEPPA PIG



135021
PATRULLA CANINA



135013
FROZEN



135017
SPIDER-MAN



135020
MR WONDERFUL

OBLEA

Wafer · Azyme · Obreia · Cialda

Ø 20 cm

114398

SPIDER-MAN

Ø 20 cm ·  x 6



114367

SPIDER-MAN

Ø 20 cm ·  x 6



21 cm

26,3 cm

OBLEA

Wafer · Azyme · Obreia · Cialda

114402
AVENGERS

Ø 20 cm ·  x 6



114401
AVENGERS

Ø 20 cm ·  x 6



OBLEA

Wafer · Azyme · Obreia · Cialda

160137

JUSTICE LEAGUE

Ø 20 cm ·  x 6



NEW

160156

TORTUGAS NINJA

Ø 20 cm ·  x 6





OBLEA

Wafer · Azyme · Obreia · Cialda

160183



MR WONDERFUL

Ø 20 cm ·  x 6 



160160

BOB ESPONJA



Ø 20 cm ·  x 6 



OBLEA



Wafer · Azyme · Obreia · Cialda

114378
MICKEY

Ø 20 cm ·  x 6 



160132
PJ MASKS

Ø 20 cm ·  x 6 





OBLEA

Wafer · Azyme · Obreia · Cialda

160117



PAW PATROL

Ø 20 cm ·  x 6 



160129

PAW PATROL

Ø 20 cm ·  x 6 



OBLEA

Wafer · Azyme · Obreia · Cialda

114370

CARS 3

Ø 20 cm ·  x 6



145093

DINOSAURIO

Dinosaur - Dinosaur - Dinosauro - Dinosaurio

Ø 20 cm ·  x 6



OBLEA

Wafer · Azyme · Obreia · Cialda

NEW

160190
BARBIE

Ø 20 cm ·  x 6



NEW

160186
WONDER WOMAN



Ø 20 cm ·  x 6



OBLEA



Wafer · Azyme · Obreia · Cialda

114382
FROZEN

Ø 20 cm ·  x 6 



114383
FROZEN

Ø 20 cm ·  x 6 





OBLEA

Wafer · Azyme · Obreia · Cialda

114366



FROZEN

Ø 20 cm ·  x 6 



114377

PRINCESAS

Ø 20 cm ·  x 6 





OBLEA

Wafer · Azyme · Obreia · Cialda

160163



PAW PATROL

Ø 20 cm ·  x 6 



160131

PEPPA PIG



Ø 20 cm ·  x 6 



OBLEA



Wafer · Azyme · Obreia · Cialda

114371
MINNIE

Ø 20 cm ·  x 6 



114381
MINNIE

Ø 20 cm ·  x 6 



OBLEA

Wafer · Azyme · Obreia · Cialda

160174

MY LITTLE PONY

Ø 20 cm ·  x 6



145099

SIRENITA

Ø 20 cm ·  x 6





OBLEA

Wafer · Azyme · Obreia · Cialda

145096

UNICORNIO

Unicornio - Licorne - Unicórnio



Ø 20 cm ·  x 6 



145086

UNICORNIO

Unicornio - Licorne - Unicórnio

Ø 20 cm ·  x 6 



OBLEA

Wafer · Azyme · Obreia · Cialda

NEW

145114

FÚTBOL

Football - Futebol

Ø 20 cm ·  x 6

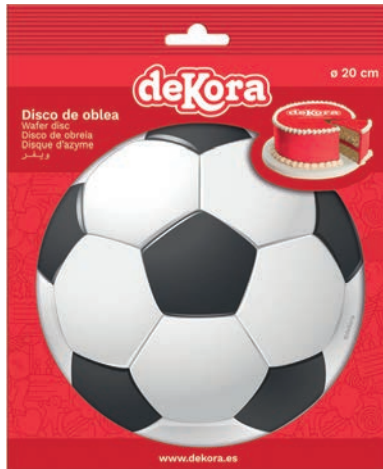

145094

FÚTBOL

Football - Futebol

Ø 20 cm ·  x 6

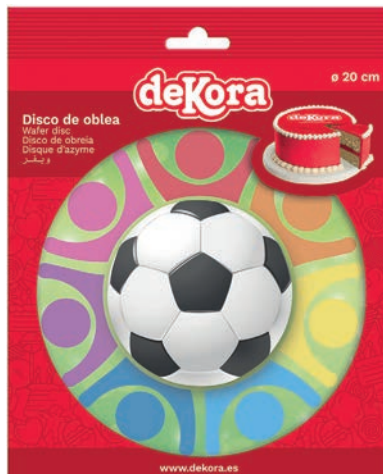

OBLEA

Wafer · Azyme · Obreia · Cialda

Mini discos de oblea 3,4 cm

Wafer mini edible discs - Mini disques de azyme - Mini discos obreia
Mini dischi in cialda



145102

MINI BALONES FÚTBOL



Troqueladas - Pre-cut

Pré-découpées - Sagomati

Ø 3,4 cm ·  x 6  x 20 





145109
MINI BABY SHOWER BOY
 Troqueladas - Pre-cut
 Pré-découpées - Sagomati
 Ø 3,4 cm ·  x 6  x 20 



145108
MINI BABY SHOWER GIRL
 Troqueladas - Pre-cut
 Pré-découpées - Sagomati
 Ø 3,4 cm ·  x 6  x 20 



Siluetas de oblea

Wafer silhouette - Silhouette de azyme - Silhueta obreia - Sagome in cialda



114412
FROZEN
 Troqueladas - Pre-cut
 Pré-découpées - Sagomati
 14,8 x 21 cm · x 6





160182
PEPPA PIG
 Troqueladas - Pre-cut
 Pré-découpées - Sagomati
 14,8 X 21 cm · x 6



OBLEA

Wafer · Azyme · Obreia · Cialda



160181
PAW PATROL - SKYE
Troqueladas - Pre-cut
Pré-découpées - Sagomati
14,8 x 21 cm ·  x 6 





160167
PAW PATROL - CHASE
Tro



OBLEA

Wafer · Azyme · Obreia · Cialda

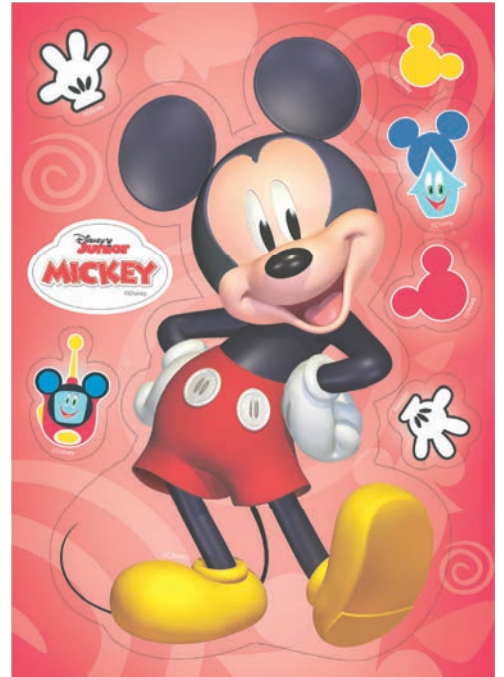

114418
MICKEY
Troqueladas - Pre-cut
Pré-découpées - Sagomati
14,8 x 21 cm ·  x 6 



114419
MINNIE
Troqueladas - Pre-cut
Pré-découpées - Sagomati
14,8 x 21 cm ·  x 6 



OBLEA

Wafer · Azyme · Obreia · Cialda

Dekorapin de oblea

Wafer Dekorapin - Dekorapin azyme - Dekorapin obreia - Dekorapin cialda



135050

PEPPA PIG

Troqueladas - Pre-cut

Pré-découpées - Sagomati

6,5 x 4 cm

☞ x 6 ☞ x 2 ☞ x 10 ☞



135021

PATRULLA CANINA

Troqueladas - Pre-cut

Pré-découpées - Sagomati

6,5 x 4 cm

☞ x 6 ☞ x 2 ☞ x 10 ☞



OBLEA

Wafer · Azyme · Obreia · Cialda



135013

FROZEN

Troqueladas - Pre-cut

Pré-découpées - Sagomati

6,5 x 4 cm

📦 x 6 📄 x 2 📏 x 10 ♻️



135017

SPIDERMAN

Troqueladas - Pre-cut

Pré-découpées - Sagomati

6,5 x 4 cm

📦 x 6 📄 x 2 📏 x 10 ♻️



OBLEA

Wafer · Azyme · Obreia · Cialda



135020

MR WONDERFUL

Troqueladas - Pre-cut

Pré-découpées - Sagomati

6,5 x 4 cm

📦 x 6 📦 x 2 📦 x 10 ♡



deKora



OBLEA

Wafer · Azyme · Obreia · Cialda



126140
12,5 cm · 1 u.



126142
12,5 cm · 1 u.



126141
12,5 cm · 1 u.





NEW

126174

12,5 cm ·  1 u.



NEW

126172

12,5 cm ·  1 u.



NEW

126173

12,5 cm ·  1 u.



OBLEA

Wafer · Azyme · Obreia · Cialda



126162

5,5 cm · 18 u.



126163

5,5 cm · 18 u.



126155

7 cm · x 15 u.



126154

7 cm · x 15 u.



OBLEA

Wafer · Azyme · Obreia · Cialda



126150

6,5 - 7 cm · 6 u.



126158

6,5 - 7 cm · x 6 u.



126166

4,5 cm · 12 u.



126149

4,5 cm · 12 u.



OBLEA

Wafer · Azyme · Obreia · Cialda



NEW

126171

Ø 7 cm · 15 u.



126161

7 cm · 15 u.



126065

4,5 cm · 36 u.



OBLEA

Wafer · Azyme · Obreia · Cialda



126168
2 cm ·  400 u.



126167
2 cm ·  400 u.



126138
2 cm ·  400 u.



126069
2 cm ·  400 u.



126068
2 cm ·  400 u.





OBLEA

Wafer · Azyme · Obreia · Cialda



126165

8,5 x 7,5 cm ·  x 10 u.



126164

8,5 x 7,5 cm ·  x 10 u.



126067

8,5 x 7,5 cm ·  x 10 u.



126151

8,5 x 7,5 cm ·  x 10 u.



126156

8,5 x 7,5 cm ·  x 10 u.



126066

8,5 x 7,5 cm ·  x 10 u.



126157

8,5 x 7,5 cm ·  x 10 u.



YouTube

OBLEA

Wafer · Azyme · Obreia · Cialda



126091

4,5 cm ·  150 u.



126086

4,5 cm ·  150 u.



126033

4,5 cm ·  100 u.



126027

4,5 cm. ·  x 100 u.



OBLEA

Wafer · Azyme · Obreia · Cialda



126159
3 cm · 150 u



126023
4,5 cm · 100 u.



126100
4 cm · 120 u.



126043
5 cm · 100 u.



OBLEA

Wafer · Azyme · Obreia · Cialda



126128

3 cm · 100 u.



126160

3 cm · 100 u.



126010

4 cm · 72 u.



126008

4 cm · 72 u.



126007

4 cm · 72 u.



126084

4,5 cm · 50 u.



126083

4,5 cm · 50 u.



126080

4,5 cm · 50 u.



126081

4,5 cm · 50 u.



126082

4,5 cm · 50 u.



OBLEA

Wafer · Azyme · Obreia · Cialda



126092

3 cm · 150 u.



126095

3 cm · 150 u.



126132

3,5 cm · 140 u.



126134

3,5 cm · 140 u.



126135

3,5 cm · 140 u.



126133

3,5 cm · 140 u.



126056

4 cm · 80 u.



126025

4 cm · 100 u.



OBLEA

Wafer · Azyme · Obreia · Cialda



126130

4 cm

75 u.



126137

6,5 x 6,5 cm

30 u.



126136

6,5 cm · 80 u.



126107

8,5 cm

50 u.



OBLEA

Wafer · Azyme · Obreia · Cialda



126070
 PERLADA - Pearl
 Nacré - Pérola
 4,2 cm · 400 u.



126074
 PERLADA - Pearl
 Nacré - Pérola
 4,2 cm · 400 u.



126071
 PERLADA - Pearl
 Nacré - Pérola
 4,2 cm · 400 u.



115017
 4,5 cm · 1000 u.



115013
 4,5 cm · 1000 u.



115009
 4,5 cm · 500 u.



130010
 4 cm · 200 u.





WAFER CAKE DECORATION KITS

Kits decoraciones de Oblea - Kits décorations en Azyme - Kits decorações em Obreia
Kit decorazioni cialda



166015



Surtido - Assortment
Assortiment - Sortimento
Assortimento

2,5 g ·  x 15  x 8 u.



166014



Surtido - Assortment
Assortiment - Sortimento
Assortimento

2,5 g ·  x 24  x 8 u.



166016

Surtido - Assortment
Assortiment - Sortimento
Assortimento

4 g ·  x 6  x 8 u.



NEW **166022**

 x 12 

NEW **166023**

 x 12 

NEW **166024**

 x 12 

deKora
 Decoración comestible
 Edible decoration · Décoration comestible · Decoração comestível

 17 cm
 7,3 cm
 www.dekora.es

 x 4

 x 2

 x 2



 19 cm
 18 cm
 7,5 cm

166017
 2 g ·  x 12  x 8 u.



deKora
 Decoración comestible
 Edible decoration · Décoration comestible · Decoração comestível

 www.dekora.es

 x 5

 x 8

 x 25

166020
 3 g ·  x 8  x 38 u.



OBLEA

Wafer · Azyme · Obreia · Cialda



126170
3-6 cm · 79 u.

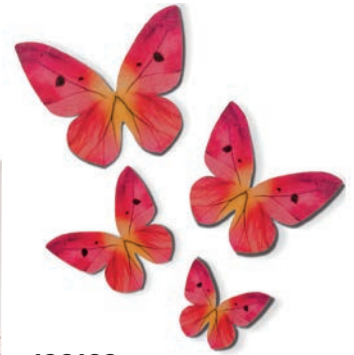

126169
3-6 cm · 79 u.



126139
3-6 cm · 87 u.



126148
3-6 cm · 79 u.



126000
4 cm · 200 u.



OBLEA

Wafer · Azyme · Obreia · Cialda



115020

Ø 1,5 cm

504 u.



115000

2D

5 cm · 200 u.



126076

2D

2 cm · 495 u.



115018



3,5 cm

200 u.







135111

9,2 x 3,2 cm ·  x 3  x 40 u. = 120 u.



135112

9,2 x 3,2 cm ·  x 3  x 40 u. = 120 u.



126006

GLOBOS DE OBLEA

Wafer globes - Ballons en azyme -
Globos de obreia - Palloncini di cialda
8 cm ·  50 u.



OBLEA INDUSTRIAL

Industrial wafer - Azyme industrielle - Obreia industrial - Cialda industriale



107033

Ø 20 cm
150 u.



OBLEA INDUSTRIAL CIRCULAR: 1 CARA LISA/ 1 CARA RAYADA

Industrial wafer rounded: 1 Face smooth / 1 face lined.
Azyme industrielle ronde: 1 Face lisse / 1 face rayée.
Obreia industrial circular: 1 Cara lisa / 1 cara rayada.
Cialda industriale circolare: 1 Faccia liscia / 1 faccia rigata.

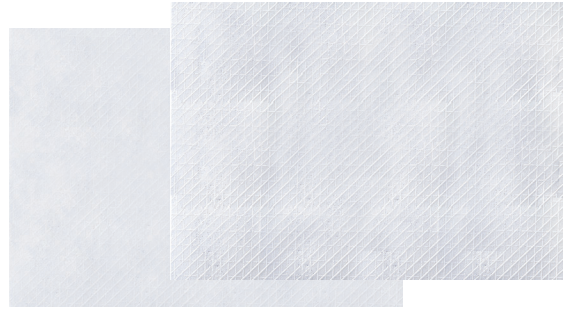

107020

50 x 40 cm
2 kg.



OBLEA INDUSTRIAL RECTANGULAR: 1 CARA LISA/ 1 CARA RAYADA

Industrial wafer rectangular: 1 Face smooth / 1 face lined.
Azyme industrielle rectangulaire: 1 Face lisse / 1 face rayée.
Obreia industrial retangular: 1 Cara lisa / 1 cara rayada.
Cialda industriale rettangolare: 1 Faccia liscia / 1 faccia rigata.

107022

70 x 40 cm
3 kg.



OBLEA PARA IMPRIMIR

Wafer ready to print · Azyme pour imprimer · Obreia para imprimir · Cialda da stampare



107127

DOBLE CARA LISA

Double smooth face
Double face lisse.
Doppia faccia liscia.
29,7 x 42 cm - DIN A3
50 u. · 0,6 mm. aprox



107117

DOBLE CARA LISA

Double smooth face
Double face lisse.
Doppia faccia liscia.
21 x 29,7 cm - DIN A4
50 u.
650 g. aprox. · 0,6 mm. aprox



107031

UNA CARA LISA PARA MÁQUINAS DE ULTIMA GENERACIÓN

One smooth face for new generations printers.
Une face lisse.
Una faccia liscia per macchine di ultima generazione
21 x 29,7 cm - DIN A4
50 u.
270 g. aprox. · 0,27 mm. aprox



LETREROS PERSONALIZADOS

Edible label - Label comestible - Obreia personalizada

Targhette personalizzate commestibili



400000 LETRERO OBLEA PERSONALIZADO CALIDAD DD

Wafer edible label DD - Étiquette comestible en azyme - Obreia personalizada DD - Targhetta cialda personalizzata qualità DD
4 cm ·  200 u.
270 g. aprox. · 0,27 mm. aprox

PEDIDO MÍNIMO
Minimum order - Minimum commande
Ordine minimo: 15.000 u.



400001 LETRERO OBLEA OVALADA PERSONALIZADA CALIDAD DD

Wafer edible label DD - Étiquette comestible en azyme - Obreia personalizada DD - Targhetta cialda personalizzata qualità DD
2,5 x 4 cm ·  200 u.
270 g. aprox. · 0,27 mm. aprox

PEDIDO MÍNIMO
Minimum order - Minimum commande
Ordine minimo: 15.000 u.



deKora



AZÚCAR & JELLY

Sugar & jelly · Sucre et jelly · Açúcar e jelly · Zuccherò e jelly

AZÚCAR

Sugar · Sucre · Açúcar · Zucchero



205161

2D/3D

A: 2,7 x 2 x 0,5 cm

B: 3,7 x 1,9 x 0,5 cm

C: 3,8 x 1,5 x 0,4 cm

128 u.



(A) (B) (C)



205186

AZÚCAR A: 2D · B: 3D

Sugar - Sucre - Açúcar

Zucchero

5,5 cm · 16 u.



AZÚCAR

Sugar · Sucre · Açúcar · Zucchero



205188

AZÚCAR 3D

Sugar - Sucre - Açúcar - Zucchero

4 - 6 cm ·  x  18 u.



205057

AZÚCAR 2D/3D

Sugar - Sucre - Açúcar - Zucchero

A: 8 cm - B: 5 cm - C: 10 cm - D: 10 cm

E: 8 cm - F: 6 cm

 16 u. (4A + 4B + 2C + 1D + 2E + 3F)



AZÚCAR

Sugar · Sucre · Açúcar · Zucchero



205120
3D
4,5 x 3,5 cm ·  48 u.



205077
2D
2,8 x 3,1 cm ·  48 u.



205119
2D
2,8 x 3 cm ·  48 u.



AZÚCAR

Sugar · Sucre · Açúcar · Zucchero



205014

3D

2,9 x 3,2 cm ·  48 u.



205124

3D

4 x 4,4 cm ·  48 u.



AZÚCAR

Sugar · Sucre · Açúcar · Zucchero



211111

2D

A: 4,5 x 6 cm / B: 4,2 x 7 cm

C: 4,9 x 5,9 cm / D: 5,4 x 2,9 cm

E: 6 x 3,1 cm

50 u.



205118

3D

2,5 x 2,7 cm · 48 u.



205135

2D

4 x 4,4 cm · 48 u.



AZÚCAR

Sugar · Sucre · Açúcar · Zucchero



205191
MACARONS
x 8 x 6 u.



205190
MACARONS
72 u.



AZÚCAR

Sugar · Sucre · Açúcar · Zucchero



NEW

205200

2D

A: 4,5 cm

B: 2,5 x 3 cm

25 u.



NEW

205201

2D

4 cm · 24 u.



211100

2D

5 cm · 60 u.



AZÚCAR

Sugar · Sucre · Açúcar · Zucchero



NEW

205204

2D

3 x 2 cm ·  48 u.



A



B



C



D

NEW

205203

2D SABOR MERENGUE

Meringue flavour

Goût de meringue

Sabor a merengue

Sabor merengue

A: 3,5 x 3 x 0,8 cm

B: Ø 2 x 0,5 cm

C: 3 x 2,5 x 0,8 cm

 50 u.



A



A



B



C



C

NEW

205202

2D

A: 4,5 x 2,5 x 0,9 cm

B: 3,5 x 1,8 x 0,9 cm

C: 3 x 2 x 0,6 cm

 48 u.



205166

3D

2 x 3 cm ·  84 u.



205159

3D

1,5 cm ·  100 u.



AZÚCAR

Sugar · Sucre · Açúcar · Zucchero



205185

2D

2,5 - 2 cm ·  98 u.



205133

3D

4 x 4,4 cm ·  48 u.



205056

4 - 5,5 cm

 16 u. (6A + 4B + 6C)



AZÚCAR

Sugar · Sucre · Açúcar · Zucchero



230042

2D

14 g · 2 - 3 cm.

📦 x 15 📦 x 8 u.



230035

2D

19 g · 2 - 3 cm.

📦 x 15 📦 x 8 u.



AZÚCAR

Sugar · Sucre · Açúcar · Zucchero



210127
5 / 6 / 7 cm
12 u.



210126
5 / 6 / 7 cm
12 u.



210120
Ø 7 cm · 9 u.



210117
Ø 7 cm · 6 u.



AZÚCAR

Sugar · Sucre · Açúcar · Zucchero



210092

AZÚCAR BLANDO

Soft sugar - Sucre doux
Açúcar mole - Zucchero morbido

3,5 x 1,8 cm ·  36 u.



210058

Ø 4 cm ·  36 u.



210021

Ø 2 cm ·  100 u.



210022

Ø 3 cm ·  76 u.



210056

Ø 4 cm ·  36 u.



AZÚCAR

Sugar · Sucre · Açúcar · Zucchero



205158

3 x 3 cm ·  48 u.



210112

PERLADA

Pearl - Nacré - Pérola
Perlata

Ø 4 cm ·  16 u.



210104

Ø 5 cm ·  10 u.



205065

Ø 7 cm ·  15 u.



AZÚCAR

Sugar · Sucre · Açúcar · Zucchero



210019

Ø 2 cm ·  128 u.



205064

Ø 5 cm ·  20 u.



AZÚCAR

Sugar · Sucre · Açúcar · Zucchero



210067

Ø 4 cm

40 u.



210121

Ø 1,5 cm · 500 u.



210028

Ø 3,5 cm

64 u.



210122

Ø 2,5 cm

150 u.



AZÚCAR

Sugar · Sucre · Açúcar · Zucchero



211005
Ø 2,5 cm
288 u.



211007
Ø 1,5 cm
490 u.



211024
Ø 2 cm
315 u.



210125
3,5 cm · 70 u



210046
Ø 4 cm · 75 u.



210013
Ø 4 cm · 40 u.



AZÚCAR

Sugar · Sucre · Açúcar · Zucchero



211090

Ø 2,5 cm · 120 u.



205109

5,7 x 4,2 cm · 24 u.



205157

67 u. (40A + 27B)

A: 4,5 x 3,5 cm. / B: 6,5 x 5,5 cm.



205156

3,7 cm.

200 u.



211013

3,5 cm

96 u.



211004

3,5 cm

100 u.



AZÚCAR

Sugar · Sucre · Açúcar · Zucchero



210020

Ø 3,5 cm

36 u.



205108

6 X 2,5 cm · 48 u.



211089

7 cm

15 u.



AZÚCAR

Sugar · Sucre · Açúcar · Zucchero



NEW

210129

1,5 - 2,5 cm. ·  210 u.



NEW

210131

7 cm. ·  6 u.



AZÚCAR

Sugar · Sucre · Açúcar · Zucchero



210114

Ø 2 cm

250 u.



NEW

210133

Ø 3,2 cm

45 u.



NEW

210130

Ø 4,5 cm

48 u.



NEW

210132

Ø 6,5 cm

12 u.



AZÚCAR

Sugar · Sucre · Açúcar · Zucchero



230063

8 + 5
 x 12



230064

8 + 5
 x 12



230062

8 + 5
 x 12



230058

7 + 5
 x 12



230057

7 + 5
 x 12



230061

8 + 5
 x 12



17 cm

7,2 cm

AZÚCAR

Sugar · Sucre · Açúcar · Zucchero



230059

7 🌸 + 7 🌸
📦 x 12 📦



230060

7 🌸 + 7 🌸
📦 x 12 📦



230065

5 🌸 + 4 🦋 oblea/wafer
📦 x 12 📦



**Disfruta de esta receta
y muchas más en nuestro canal
de YouTube ¡Sube a otro nivel!**

Enjoy this recipe and many more on our
YouTube channel. Go to another level!

youtube.com/dekorainnova



AZÚCAR

Sugar · Sucre · Açúcar · Zucchero



210080 

6,5 x 6,5 / 4,5 x 4,5 cm.

 14 u. (5A + 5B + 2C + 2D)



220016 

13 cm ·  6 u.



 DEKORA RECOMIENDA NO INGERIR ESTOS PRODUCTOS PORQUE CONTIENEN PARTES METÁLICAS

 Dekora recommends not to swallow these products since they contain metallic parts

 Dekora recommande de ne pas ingérer ces produits car ils contiennent des parties métalliques

 Dekora recomienda no ingerir estos productos porque contienen partes metálicas.

 Dekora sconsiglia di ingerire questi prodotti poiché contengono particelle di metallo.

AZÚCAR

Sugar · Sucre · Açúcar · Zucchero



H: 14 cm



H: 14 cm



H: 10 cm



H: 10 cm

220020 ENVASADO INDIVIDUAL

Individual packaging
Emballé individuel
Embalado individual
Confezione individuale

 6 u.



H: 10 cm

 DEKORA RECOMIENDA NO INGERIR ESTOS PRODUCTOS PORQUE CONTIENEN PARTES METÁLICAS

 Dekora recommends not to swallow these products since they contain metallic parts

 Dekora recommande de ne pas ingérer ces produits car ils contiennent des parties métalliques

 Dekora recomenda no ingerir estes produtos porque contém partes metálicas.

 Dekora sconsiglia di ingerire questi prodotti poiché contengono particelle di metallo.

AZÚCAR

Sugar · Sucre · Açúcar · Zucchero



210016 
9 x 9 / 6 x 6 cm.
 14 u.



211106 
7,6 cm ·  20 u.



211105 
8 cm ·  20 u.



210018 
8 x 8 cm ·  20 u.



 DEKORA RECOMIENDA NO INGERIR ESTOS PRODUCTOS PORQUE CONTIENEN PARTES METÁLICAS

 Dekora recommends not to swallow these products since they contain metallic parts

 Dekora recommande de ne pas ingérer ces produits car ils contiennent des parties métalliques

 Dekora recomienda no ingerir estos productos porque contienen partes metálicas.

 Dekora sconsiglia di ingerire questi prodotti poiché contengono particelle di metallo.

AZÚCAR





Sugar · Sucre · Açúcar · Zucchero



220011 
10,5 cm ·  6 u. 



220012 
10,5 cm ·  6 u. 

-  DEKORA RECOMIENDA NO INGERIR ESTOS PRODUCTOS PORQUE CONTIENEN PARTES METÁLICAS
-  Dekora recommends not to swallow these products since they contain metallic parts
 -  Dekora recommande de ne pas ingérer ces produits car ils contiennent des parties métalliques
 -  Dekora recomenda no ingerir estes produtos porque contém partes metálicas.
 -  Dekora sconsiglia di ingerire questi prodotti poiché contengono particelle di metallo.

AZÚCAR

Sugar · Sucre · Açúcar · Zucchero







220004 
15 cm ·  6 u.



AZÚCAR

Sugar · Sucre · Açúcar · Zucchero



-  DEKORA RECOMIENDA NO INGERIR ESTOS PRODUCTOS PORQUE CONTIENEN PARTES METÁLICAS
-  Dekora recommends not to swallow these products since they contain metallic parts
-  Dekora recommande de ne pas ingérer ces produits car ils contiennent des parties métalliques
-  Dekora recomenda no ingerir estes produtos porque contêm partes metálicas.
-  Dekora sconsiglia di ingerire questi prodotti poiché contengono particelle di metallo.

AZÚCAR

Sugar · Sucre · Açúcar · Zucchero



 DEKORA RECOMIENDA NO INGERIR ESTOS PRODUCTOS PORQUE CONTIENEN PARTES METÁLICAS

 Dekora recommends not to swallow these products since they contain metallic parts

 Dekora recommande de ne pas ingérer ces produits car ils contiennent des parties métalliques

 Dekora recomienda no ingerir estos productos porque contêm partes metálicas.

 Dekora sconsiglia di ingerire questi prodotti poiché contengono particelle di metallo.

AZÚCAR

Sugar · Sucre · Açúcar · Zucchero





210026 
15 cm ·  5 u.



 **DEKORA RECOMIENDA NO INGERIR ESTOS PRODUCTOS PORQUE CONTIENEN PARTES METÁLICAS**

 Dekora recommends not to swallow these products since they contain metallic parts

 Dekora recommande de ne pas ingérer ces produits car ils contiennent des parties métalliques

 Dekora recomenda no ingerir estes produtos porque contêm partes metálicas.

 Dekora sconsiglia di ingerire questi prodotti poiché contengono particelle di metallo.



AZÚCAR

Sugar · Sucre · Açúcar · Zucchero



26 cm

211109 
26 cm ·  12 u. (4 x 3)



26 cm

211043 
26 cm ·  12 u. (4 x 3) 



26 cm

211108 
26 cm ·  12 u. (4 x 3) 

 DEKORA RECOMIENDA NO INGERIR ESTOS PRODUCTOS PORQUE CONTIENEN PARTES METÁLICAS

 Dekora recommends not to swallow these products since they contain metallic parts

 Dekora recommande de ne pas ingérer ces produits car ils contiennent des parties métalliques

 Dekora recomenda no ingerir estes produtos porque contém partes metálicas.

 Dekora sconsiglia di ingerire questi prodotti poiché contengono particelle di metallo.

deKora

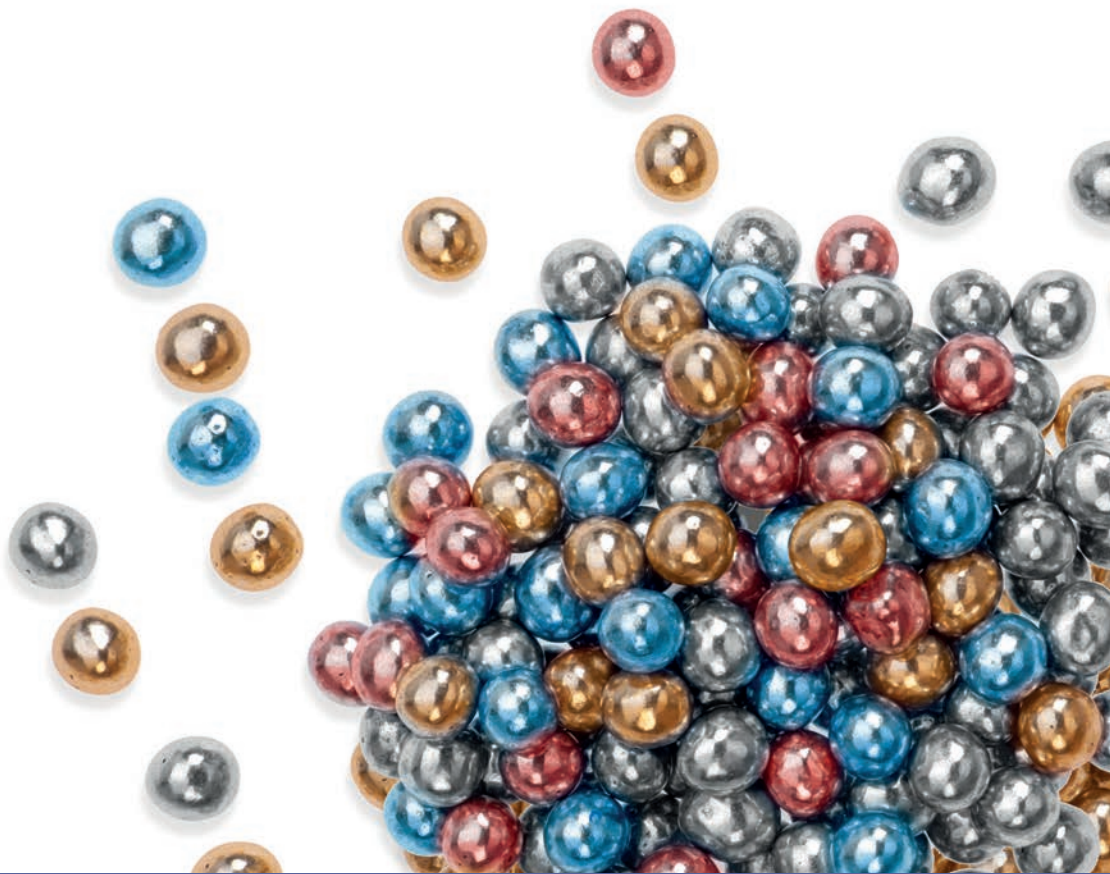

TOPPING

Topping decoration · Décoration topping
Decoração topping · Decorazione topping

TOPPING

Topping decoration · Décoration topping · Decoração topping · Decorazione topping

FIDEOS DE OBLEA

Colour wafer strands · Vermicelles en azyne · Fidéus de obreia · Fedelini di cialda



440014
x 210 g



440016
x 210 g



440017
x 210 g



CONFETTI

Azúcar- Sugar - Sucre- Zucchero



445084
1 kg



Presentación / Presentation



445082
1 kg



445018
1 kg



445021
1 kg



445020
1 kg



445019
1 kg



TOPPING

Topping decoration · Décoration topping · Decoração topping · Decorazione topping
AZÚCAR · SUGAR · SUCRE · AÇÚCAR · ZUCCHERO

FIDEOS DE AZÚCAR

Sugar strands · Vermicelles en sucret · Fidéus de açúcar · Fedelini di zucchero



440025
1,2 kg









440026
1,2 kg









440004
1,2 kg







440007
20 kg









NEW **440029**
1,2 kg









440023
1,2 kg









440024
1,2 kg









443016
25 kg



443006
1,5 kg



<20ppm gluten REG. 1169/2011



TOPPING

Topping decoration · Décoration topping · Decoração topping · Decorazione topping

AZÚCAR · SUGAR · SUCRE · AÇÚCAR · ZUCCHERO

MERENGUITOS

Meringue



211101

350 g



211103

350 g



210061

90 g



210062

90 g



210063

90 g



210059

80 g



210060

80 g



210103

90 g

Surtidas - Assorted - Assorties
Sortidas - Assortimento







TOPPING

Topping decoration · Décoration topping · Decoração topping · Decorazione topping
AZÚCAR · SUGAR · SUCRE · AÇÚCAR · ZUCCHERO

AZÚCARES BRILLANTES

Bright sugars · Sucres colorés · Açúcares brilhantes · Brillantini di zucchero

IDEALES PARA DECORAR TARTAS, BIZCOCHOS, POSTRES, ETC. FIJACIÓN PERFECTA EN FRIGORÍFICO, ABATIDOR Y HORNO.

-  Ideal for decorating cakes, biscuits, desserts, etc. Perfect hold in the fridge, in the blast chiller and over.
-  Parfaits pour décorer des tartes, gâteaux, etc. Tenue parfaite au réfrigérateur, au congélateur et au four.
-  Ideais para decorar bolos, biscoitos, sobremesas, etc. Consistência perfeita no frigorífico, congelador ou forno.
-  Perfetti per la decorazione di torte, ciambelle, dolci, ecc. Fissaggio ottimale in frigo, abbattitore o forno.



445076
PLATA - Silver
Argent - Prata - Argento
700 g

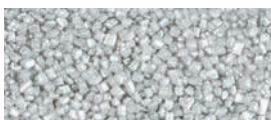

445075
RUBY
700 g



445073
ORO - Gold - Or - Ouro
700 g



TOPPING

Topping decoration · Décoration topping · Decoração topping · Decorazione topping

PERLAS

Pearls · Perles · Pérola · Perle

AZÚCAR + CHOCOLATE + CRUJIENTE Sugar + Chocolate + Crispy - Sucre + Chocolat + Croquant - Açúcar + Chocolate + Crocante - Zuccheri + Cioccolato + Crocante

IDEALES PARA DECORAR TARTAS, BIZCOCHOS, POSTRES, ETC. FIJACIÓN PERFECTA EN FRIGORÍFICO, Y ABATIDOR.

 Ideal for decorating cakes, biscuits, desserts, etc. Perfect hold in the fridge and in the blast chiller.

 Parfaits pour décorer des tartes, gâteaux, etc. Tenue parfaite au réfrigérateur et au congélateur.

 Ideais para decorar bolos, biscoitos, sobremesas, etc. Consistência perfeita no frigorífico ou congelador.

 Perfetti per la decorazione di torte, ciambelle, dolci, ecc. Fissaggio ottimale in frigo o abbattitore.



433071

Ø 0,5 - 0,6 cm ·  350 g



433073

Ø 0,5 - 0,6 cm ·  350 g



433083

Ø 1,7 - 2 cm ·  350 g



433079

Ø 0,6 cm

 350 g



YouTube

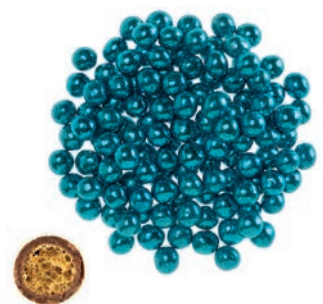

433080

Ø 0,6 cm

 350 g



TOPPING

Topping decoration · Décoration topping · Decoração topping · Decorazione topping

AZÚCAR | Sugar - Sucre - Açúcar - Zucchero



433082

Ø 0,2 cm

500 g



433011

Ø 0,4 cm

500 g



433002

Ø 0,4 cm

500 g



433004

Ø 0,6 cm

500 g



433084

Ø 0,5 cm

450 g



433009

Ø 0,6 cm

4 Kg



TOPPING

Topping decoration · Décoration topping · Decoração topping · Decorazione topping

AZÚCAR · SUGAR · SUCRE · AÇÚCAR · ZUCCHERO

CONFETTI

Confete



434015
CORAZONES
Hearts - Coeurs
Corações - Cuori
100 g · x 8



434016
BABY BOY
100 g · x 8



434017
BABY GIRL
100 g · x 8



NEW
434020
CONFETTI
100 g.



NEW
434021
HUEVOS
Eggs - Œufs
Ovos - Uova
100 g.



434009
CORAZONES
Hearts - Coeurs
Corações - Cuori
100 g · x 8



434007
ESTRELLAS
Stars - Étoiles
Estrelas - Stelle
100 g · x 8



TOPPING

Topping decoration · Décoration topping · Decoração topping · Decorazione topping

AZÚCAR · SUGAR · SUCRE · AÇÚCAR · ZUCCHERO

SPRINKLES



230066 COLORES+CONEJITOS

56 g · x 10
Surtidas - Assorted
Assorties - Sortidas
Assortimento



230067 COLORES+UNICORNIOS

56 g · x 10
Surtidas - Assorted
Assorties - Sortidas
Assortimento



230068 COLORES+CORAZONES +ESTRELLAS

56 g · x 10
Surtidas - Assorted
Assorties - Sortidas
Assortimento



OJOS DE CARAMELO

Candy eyeballs · Bonbons yeux · Olhos de caramelo · Occi di caramella



230051

56 g x
 x 10



230052

56 g x
 x 10
Surtidas - Assorted
Assorties - Sortidas



TOPPING

Topping decoration · Décoration topping · Decoração topping · Decorazione topping

CHOCOLATE · CHOCOLAT · CIOCCOLATO

CHOCOLATE CRISPY

Chocolate + Crispy · Chocolat + Croquant
Chocolate + Crocante · Cioccolato + Crocante

17,3 cm



10,8 cm



YouTube



YouTube

433067

70 g ·  x 8 

Surtidas - Assorted
Assorties - Sortidas
Assortimento



YouTube

433078

80 g ·  x 8 

Surtidas - Assorted
Assorties - Sortidas
Assortimento



13 cm



29 cm

9 cm

deKora



CHOCOLATE

Chocolate decoration · Décoration chocolat
Decoração chocolate · Cioccolato

CHOCOLATE

Chocolate · Chocolat · Cioccolato



427765

3D

Negro/Blanco

Dark/White - Noir/Blanc

Preto/Branco - Nero/Bianco

Ø 6,5 x H: 3 cm

84 u. · Vol: 60 ml.



427915

3D

Negro - Dark - Noir

Preto - Nero

2,5 x 2,8 cm

150 u.



427807

3D

Negro - Dark - Noir

Preto - Nero

Ø 4,9 x H: 3,5 cm

168 u. · Vol: 23 ml.



427083

3D

Negro - Dark - Noir

Preto - Nero

Ø 4,4 x 2,8 x H: 2 cm

168 u. · Vol: 16 ml.



427756

3D

Negro - Dark - Noir

Preto - Nero

Ø 8 x H: 7,5 cm

22 u. · Vol: 100 ml.



427660

3D

Con leche - With milk

Au lait - Com leite - Al latte

Ø 2,5 cm · 504 u.

Vol: 5 ml.

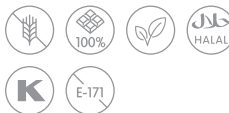

427662

3D

Negro - Dark - Noir -

Preto - Nero

Ø 2,5 cm · 504 u.

Vol: 5 ml.



CHOCOLATE

Chocolate · Chocolat · Cioccolato



428120

3D

Blanco - White - Blanc

Branco - Bianco

Ø 3 cm

56 u.



428119

3D

Negro - Dark

Noir - Preto - Nero

Ø 3 cm · 56 u.



427766

3D

Blanco - White - Blanc

Branco - Bianco

Ø 2,7 cm · 40 u.



427750

3D

Negro - Dark

Noir - Preto - Nero

Ø 3 cm · 40 u.



427948

3D

Negro/Blanco

Dark/White - Noir/Blanc

Preto/Branco - Nero/Bianco

Ø 2,7 cm · 40 u.



428113

3D

Blanco - White - Blanc

Branco - Bianco

Ø 3 cm · 56 u.



CHOCOLATE

Chocolate · Chocolat · Cioccolato



427611

2D

Negro/Blanco - Dark/White
Noir/Blanc - Preto/Branco
Nero/Bianco

4,7 x 3 cm · 357 u.



427323

2D

Negro/Blanco - Dark/White
Noir/Blanc - Preto/Branco
Nero/Bianco

3,5 x 4,5 cm · 420 u.



427610

2D

Negro/Blanco - Dark/White
Noir/Blanc - Preto/Branco
Nero/Bianco

3 x 3 cm · 420 u.



NEW

428109

2D

Negro/Blanco - Dark/White
Noir/Blanc - Preto/Branco
Nero/Bianco

5,2 x 3,4 cm · 290 u.



427110

2D

Con leche/Blanco - With milk/White
Au lait/Blanc - Com leite/Branco -
Al latte/Bianco

9,6 x 4,5 x 10,5 cm · 131 u.



427109

2D

Negro/Blanco - Dark/White
Noir/Blanc - Preto/Branco
Nero/Bianco

9,6 x 4,5 x 10,5 cm · 131 u.



427145

2D

Negro/Blanco - Dark/White - Noir/
Blanc - Preto/Branco - Nero/Bianco

3,2 x H: 4,7 cm · 295 u.



427154

2D

Blanco - White - Blanc - Branco - Bianco

4,7 x H: 3,7 cm · 280 u.



427873

2D

Negro/Blanco - Dark/White - Noir/Blanc
Preto/Branco - Nero/ Bianco

6 x 3,8 cm · 220 u. 910 g



CHOCOLATE

Chocolate · Chocolat · Cioccolato

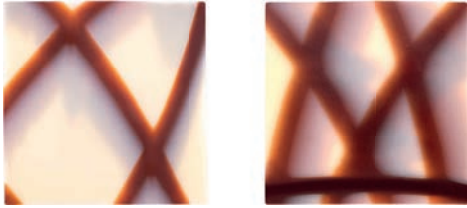

NEW

428107

2D

Blanco - White - Blanc - Branco - Bianco

4 x 4 cm · 390 u.

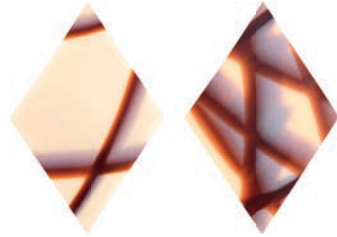

NEW

428106

2D

Blanco - White - Blanc - Branco - Bianco

3,5 x 6 cm · 390 u.



427324

2D

Negro/Blanco - Dark/White - Noir/
Blanc - Preto/Branco - Nero/Bianco

3,5 x 4 cm · 415 u.



427325

2D

Negro/Blanco - Dark/White - Noir/
Blanc - Preto/Branco - Nero/Bianco

3 x 3 cm · 485 u.



427926

2D

Blanco - White - Blanc
Branco - Bianco

4,6 x 4,6 cm

148 u.



427322

2D

Negro/Blanco - Dark/White
Noir/Blanc - Preto/Branco
Nero/Bianco

3,5 x 4 cm · 415 u.



427612

2D

Blanco - White - Blanc
Branco - Bianco

3 x 3 cm

315 u.



427753

2D

Negro - Dark - Noir
Preto - Nero

2,9 x 2,9 cm

135 u.



CHOCOLATE

Chocolate · Chocolat · Cioccolato



427929

2D

Negro - Dark - Noir
Preto - Nero

5 x 5 cm · 112 u.



YouTube



427462

3D

Negro/Blanco - Dark/White - Noir/Blanc
Preto/Branco - Nero/Bianco

Ø 1,4 - 1,5 x H: 1,9 - 2,3 cm · 500 g.



427924

3D

Negro/Blanco - Dark/White Noir/
Blanc - Preto/Branco Nero/Bianco

5,5 x 4,5 cm · 40 u.



427848

2D

Negro - Dark - Noir - Preto - Nero

5,9 x 3,5 x 0,2 cm

400 u. 1 kg



427321

3D

Negro - Dark - Noir - Preto - Nero

1,2 x 1,8 cm · 1,1 kg



427959

3D

Assortment - Assortiment

Sortimento - Assortite

4,8 x 1,6 cm

108 u.



427100

2D

Negro - Dark

Noir - Preto - Nero

4,5 x 2,5 cm

310 u.



CHOCOLATE

Chocolate · Chocolat · Cioccolato



427111

2D

Negro - Dark- Noir - Preto - Nero
3,5 x 4,5 cm

📦 275 u. · 700 g



427854

2D

Negro - Dark - Noir - Preto - Nero
6 x 2,2 cm

📦 320 u. · 680 g



427911

2D

Negro - Dark - Noir
Preto - Nero

7,5 x 2,3 x 1,1 cm

📦 48 u.



427830

3D

Negro - Dark - Noir
Preto - Nero

4 x 3 cm · 📦 105 u.



427921

3D

Negro/Blanco - Dark/White

Noir/Blanc - Preto/Branco

Nero/Bianco

5 x 3 cm

📦 333 u.



427831

3D

Blanco - White - Blanc

Branco - Bianco

4 x 3 cm · 📦 105 u.



427467

3D

Negro/Blanco - Dark/White - Noir/Blanc

Preto/Branco Nero/Bianco

7 x H: 5 cm

📦 2,5 kg ± 250 u.



427214

3D

Negro/Blanco - Dark/White - Noir/Blanc

Preto/Branco - Nero/Bianco

3,3 x H: 2,6 cm

📦 1 kg



CHOCOLATE

Chocolate · Chocolat · Cioccolato

NEW

428112

Ø 3,2 cm

80 u.



427857

2D

Blanco - White - Blanc - Branco - Bianco

3 x 3,5 cm · 252 u. 348 g



427273

3D

Negro - Dark - Noir - Preto - Nero

Ø 3,5 x H: 1,5 cm

76 u.



427274

3D

Blanco - White - Blanc

Branco - Bianco

Ø 3,5 x H: 1,5 cm · 76 u.



427829

2D

Blanco - White

Blanc - Branco - Bianco

Ø 3,4 cm · 108 u.



427665

3D

Negro - Dark - Noir

Preto - Nero

Ø 4,5 x 3 cm · 15 u.



427666

3D

Blanco - White - Blanc

Branco - Bianco

Ø 4,5 x 3 cm · 15 u.



427907

3D

Blanco - White - Blanc

Branco - Bianco

Ø 4,5 x 3 cm · 15 u.



CHOCOLATE

Chocolate · Chocolat · Cioccolato



427752

2D

Negro - Dark - Noir - Preto - Nero

3 x 4 cm · 90 u.



427667

3D

Negro - Dark - Noir - Preto - Nero

3,5 x 3 x 1,5 cm · 120 u.



428108

3D

Blanco - White - Blanc - Branco

H: 5 cm · 28 u.



427925

2D

Blanco - White - Blanc - Branco

3,3 x 1,9 cm · 144 u.



427658

2D

Surtido - Assortment

Assortiment - Sortimento - Assortite

6 x 3,3 cm · 160 u.



427895

2D

Blanco - White - Blanc

Branco - Bianco

4,5 x 2,7 cm · 140 u.



CHOCOLATE

Chocolate · Chocolat · Cioccolato

427784

2D

Blanco - White - Blanc

Branco - Bianco

Ø 5,3 cm ·  36 u.



427692

3D

Blanco - White - Blanc

Branco - Bianco

Ø 3,5 cm ·  36 u.



NEW **428094**

3D

Con leche

With milk - Au lait

Com leite - Al latte

5,5 x 4 cm ·  48 u.



NEW

428095

2D

Blanco - White - Blanc

Branco - Bianco

4 x 5 cm ·  36 u.



427749

3D

Blanco - White - Blanc

Branco - Bianco

Ø 3,5 cm ·  36 u.



NEW

428096

3D

Con leche - With milk

Au lait - Com leite - Al latte

4,6 x 3,8 cm ·  90 u.



427901

3D

Blanco - White - Blanc

Branco - Bianco

Ø 3,5 cm ·  175 u. · 500 g



427694

3D

Blanco - White - Blanc

Branco - Bianco

3,8 X 2,8 cm ·  36 u.



CHOCOLATE

Chocolate · Chocolat · Cioccolato



NEW **428103**
 3D
 Blanco - White - Blanc
 Branco - Bianco
 A: 4,2 x 3,4
 B: 4,4 x 4
 C: 4,2 x 2,7 cm
 180 u.



NEW **428111**
 5,1 x 1,9 cm
 40 u.



427955
 3D
 Blanco - White - Blanc -
 Branco - Bianco
 Ø 2,7 cm · 40 u.



NEW **427976**
 2D
 Negro - Dark - Noir - Preto - Nero
 Ø 3 cm · 135 u.



NEW **428090**
 2D
 Blanco - White - Blanc - Branco - Bianco
 Ø 3 cm · 135 u.



CHOCOLATE

Chocolate · Chocolat · Cioccolato



427835

3D

Negro/Blanco - Dark/White

Noir/Blanc - Preto/Branco - Nero/Bianco

Ø 0,5-1 x 7,5 cm · 📦 250 g.



427656

3D

Surtido / Assortment

Assortiment / Sortiment / Assortite

📦 90 u.



427468

3D

Negro/Blanco - Dark/White

Noir/Blanc - Preto/Branco

Nero/Bianco

3,3 cm · 📦 1,5 kg



427469

3D

Negro/Blanco - Dark/White

Noir/Blanc - Preto/Branco

Nero/Bianco

4 cm · 📦 2 kg



427811

3D

Negro/Blanco - Dark/White

Noir/Blanc - Preto/Branco

Nero/Bianco

Ø 0,7 x H: 9,4 cm · 📦 117 u.



427875

3D

Negro/Blanco - Dark/White

Noir/Blanc Preto/Branco

Nero/Bianco

5,5 cm

📦 1 kg.



427834

3D

Con leche/Blanco - With

milk/White - Au lait/Blanc

Com leite/Branco - Al latte/

Bianco - Bianco al latte

2,8 x Ø 0,7 cm · 📦 40 u



427809

3D

Negro/Blanco - Dark/White

Noir/Blanc - Preto/Branco

Nero/Bianco

Ø 1 x 6/6,5 cm

📦 144 u.



CHOCOLATE

Chocolate · Chocolat · Cioccolato

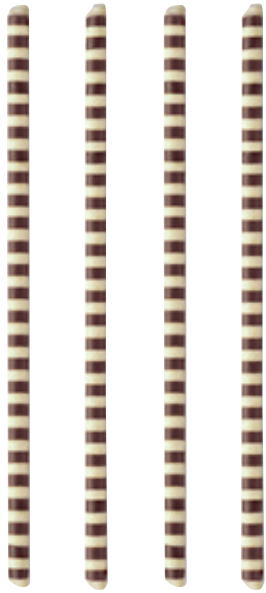

427470

3D

Negro/Blanco - Dark/White
Noir/Blanc - Preto/Branco -
Nero/Bianco

Ø 0,45 x H: 15 cm

📦 700 g ± 154 u.



427670

3D

Blanco - White Blanc
Branco - Bianco

Ø 0,6 x H: 9,7 cm

📦 210 u.



NEW **428104**

3D

Blanco - White Blanc
Branco - Bianco

Ø 0,6 x H: 13,5 cm

📦 288 u.



NEW **428093**

3D

Blanco - White Blanc
Branco - Bianco

Ø 0,5 x H: 15 cm

📦 120 u.



427733

3D

Ø 1,6 x H: 20 cm

📦 110 u. · 715 g



427734

3D

Ø 1,6 x H: 20 cm

📦 110 u. · 715 g



427737

3D

Ø 1,6 x H: 20 cm

📦 110 u. · 715 g



427657

3D

Surtido - Assortment
Assortiment - Sortimento
Assortite

📦 108 u.





CHOCOLATE

Chocolate · Chocolat · Cioccolato



428091

3D

Blanco - White - Blanc - Branco - Bianco
8,4 x 3 cm · 80 u.



428092

3D

Negro - Dark - Noir - Preto - Nero
8,4 x 3 cm · 80 u.



427812

3D

Negro - Dark - Noir - Preto - Nero
3,5 x 8 cm · 80 u.



YouTube



427703

3D

Negro - Dark - Noir - Preto - Nero
7,8 x H: 3 cm · 36 u.



427906

3D

Negro - Dark - Noir - Preto - Nero
8,4 x 3 cm · 80 u.



427909

3D

Blanco - White - Blanc - Branco - Bianco
3 x H: 17 cm · 48 u.



CHOCOLATE

Chocolate · Chocolat · Cioccolato



427838

Negro - Dark - Noir - Preto - Nero
0,9 x 0,5 cm · 1 kg

427839

Negro - Dark - Noir - Preto - Nero
0,9 x 0,5 cm · 4 kg



427842

Blanco - White - Blanc - Branco - Bianco
0,9 x 0,5 cm · 1 kg

427843

Blanco - White - Blanc - Branco - Bianco
0,9 x 0,5 cm · 4 kg



427840

Blanco - White - Blanc - Branco - Bianco
0,9 x 0,5 cm · 1 kg

427841

Blanco - White - Blanc - Branco - Bianco
0,9 x 0,5 cm · 1 kg



427844

Con leche - With milk
Au lait - Com leite - Al latte
0,9 x 0,5 cm · 1 kg



427846

Negro - Dark - Noir - Preto - Nero
0,9 x 0,5 cm · 4 kg



427847

Blanco - White - Blanc - Branco - Bianco
0,9 x 0,5 cm · 4 kg



427089

Negro - Dark - Noir - Preto - Nero
 2,5 kg



427922

Con leche - With milk
Au lait - Com leite - Al latte
2 x 0,5 cm · 1 kg



427065

Blanco - White - Blanc - Branco - Bianco
 2,5 kg



CHOCOLATE

Chocolate · Chocolat · Cioccolato



427970
Rosa - Pink
Rose - Rosa
500 g



427971
Oro blanco - White gold
Or blanc - Ouro branco
Oro bianco
500 g



427967
Verde - Green
Vert - Verde
500 g



427969
Azul - Blue
Bleu - Blu
500 g



427972
Oro - Gold - Doré
Dourado - D'oro
500 g



427968
Bronce - Bronze
Bronzo
500 g



433054
Ø 0,5 cm · 600 g



433056
Ø 1 cm · 1 kg



427668
Blanco - White - Blanc
Branco - Bianco

+/- 1 cm · 600 g



CHOCOLATE

Chocolate · Chocolat · Cioccolato

LÁMINAS DE SERIGRAFÍA



Silk-screen printing sheets - Lames de sérigraphie - Lâminas de serigrafia - Lamine da serigrafia



545203

28 x 39 cm ·  x 24 LÁMINAS SURTIDAS - Assortment of sheets - Lames assorties - Lâminas sortidas - Lamine assortite

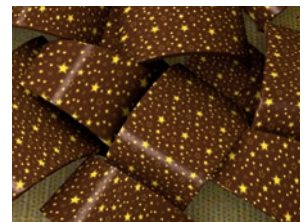
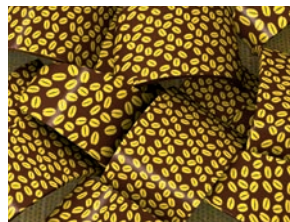
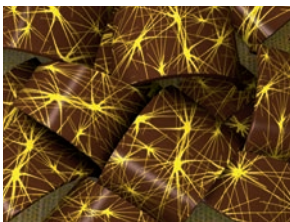

545002

28 x 39 cm ·  x 24 LÁMINAS SURTIDAS - Assortment of sheets - Lames assorties - Lâminas sortidas - Lamine assortite



CHOCOLATE

Chocolate · Chocolat · Cioccolato

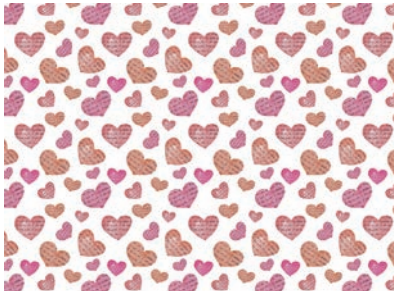

545084

21 x 14,8 cm ·  x 12 LÁMINAS SURTIDAS PARA CHOCOLATE BLANCO

Assortment of sheets for white chocolate - Lames assorties pour chocolate blanc

Lâminas sortidas para chocolate branco - Lamine assortite per cioccolato bianco



545087

21 x 14,8 cm ·  x 12 LÁMINAS SURTIDAS PARA CHOCOLATE BLANCO

Assortment of sheets for white chocolate - Lames assorties pour chocolate blanc

Lâminas sortidas para chocolate branco - Lamine assortite per cioccolato bianco



CHOCOLATE

Chocolate · Chocolat · Cioccolato



427630

Negro - Dark - Noir - Preto - Nero
Ø 9 x 5 cm · 63 u.



427007

Negro - Dark - Noir - Preto - Nero
4,6 x H: 2,6 cm · 210 u.



427008

Negro - Dark - Noir - Preto - Nero
4,6 x H: 2,6 cm · 210 u.



427715

6 x 3 cm · 60 u.



427739

Negro - Dark - Noir - Preto - Nero
4,6 x H: 2,6 cm · 210 u.



NEW **428110**

Negro - Dark - Noir - Preto - Nero
5,4 x 2,9 cm · 60 u.



427011

Negro - Dark - Noir - Preto - Nero
4,6 x H: 2,6 cm · 210 u.



NEW **428097**

Negro - Dark - Noir - Preto - Nero
4,6 x H: 2,6 cm · 90 u.



PERSONALIZACIÓN DE CHOCOLATE

Promociona tu empresa o marca de una forma exclusiva y dulce



CHOCOLATE PERSONALIZED

Promote your company or brand in an exclusive and sweet way

PERSONNALISATIONS CHOCOLAT

Faites la promotion de votre entreprise ou de votre marque de manière exclusive et douce

PERSONALIZAÇÕES CHOCOLATE

Promova sua empresa ou marca de forma exclusiva e doce

PERSONALIZZAZIONI CIOCCOLATO

Promuovi la tua azienda o il tuo marchio in modo esclusivo e dolce

CÓMO HACER TU PEDIDO

1. Elige el formato de letrero, el tipo de chocolate y el color de la tinta.
2. Selecciona la cantidad de cajas.
3. Envíanos por email el diseño en jpg o tiff en alta resolución.



HOW TO PLACE YOUR ORDER

1. Choose the sign format, the type of chocolate, and the color of the ink.
2. Select the number of boxes.
3. Send us the design in jpg or tiff in high resolution by email.

COMMENT PASSER VOTRE COMMANDE

1. Choisissez le format du signe, le type de chocolat et la couleur de l'encre.
2. Sélectionnez le nombre de cases.
3. Envoyez-nous le design en jpg ou tiff en haute résolution par email.

COMO FAZER SEU PEDIDO

1. Escolha o formato do sinal, o tipo de chocolate e a cor da tinta.
2. Selecione o número de caixas.
3. Envie-nos o desenho em jpg ou tiff em alta resolução por e-mail.

COME EFFETTUARE L'ORDINE

1. Scegli il formato del segno, il tipo di cioccolato e il colore dell'inchiostro.
2. Selezionare il numero di caselle.
3. Inviaci il disegno in jpg o tiff in alta risoluzione via email.

1 | MOLDES TERMOFORMADOS

REF. 545194

Molde termoformado de plástico, con la forma elegida, para que pueda crear su propia chocolatina personalizada.



1_FORMATO

Caja de 60 de blisters de 17 x 29 cm.
El nº de chocolatinas, dependerá del formato elegido.

2_PEDIDO MÍNIMO

1 caja.

3_TINTA LOGO

1, 2 ó 3 colores máximo.

4_CLICHÉ

Solo se paga la primera vez.

Cliché gratis en pedidos mínimos:

- 1 tinta: 3 cajas
- 2 tintas: 4 cajas
- 3 tintas: 8 cajas



THERMOFORMED MOLDS · MOULES THERMOFORMÉS · STAMPI TERMOFORMATI

EN: Thermoformed plastic mold, with the chosen shape, so you can create your own personalized chocolate bar. 1.FORMAT: Box of 60 17x29cm blisters. The number of chocolates will depend on the chosen format. 2.MINIMUM ORDER: 1 Box. 3.LOGO INK: 1, 2, or 3 colors maximum. 4.CLICHÉ: You only pay the first time. Free cliché on minimum orders: 1 ink-3 boxes, 2 inks-4 boxes, 3 inks-8 boxes. / **FR:** Moule en plastique thermoformé, à la forme choisie, pour créer votre propre tablette de chocolat personnalisée. 1.FORMAT: Carton de 60 blisters 17x29cm. Le nombre de chocolats dépendra du format choisi. 2.COMMANDE MINIMUM: 1 Boîte. 3.ENCRES LOGO: 1, 2 ou 3 couleurs maximum. 4.CLICHÉ: Vous ne payez que la première fois. Cliché gratuit sur commande minimum: 1 encre-3 boîtes, 2 encres-4 boîtes, 3 encres-8 boîtes. / **PT:** Molde de plástico termoformado, com a forma que desejar, para que possa criar a sua própria barra de chocolate personalizada. 1.FORMATO: Caixa com 60 blisters 17x29cm. A quantidade de bombons vai depender do formato escolhido. 2.PEDIDO MÍNIMO: 1 Caixa. 3. TINTA DE LOGO: 1, 2 ou 3 cores no máximo. 4.CLICHÉ: Você só paga na primeira vez. Cliché grátis em pedidos mínimos: 1 tinta-3 caixas, 2 tintas-4 caixas, 3 tintas-8 caixas. / **IT:** Stampo in plastica termoformato, con la forma prescelta, così potrai creare la tua tavoletta di cioccolato personalizzata. 1.FORMATO: Scatola da 60 blister 17x29cm. Il numero di cioccolatini dipenderà dal formato scelto. 2. ORDINE MINIMO: 1 scatola. 3.LOGO INK: 1, 2 o 3 colori massimo. 4.CLICKÉ: Pagni solo la prima volta. Cliché gratis su ordini minimi: 1 inchiostro-3 scatole, 2 inchiostri-4 scatole, 3 inchiostri-8 scatole.

REF. 427012

2 | LETREROS DE CHOCOLATE



Dinos el tamaño, forma y el tipo de chocolate que prefieres. Envíanos tu logotipo o texto que quieras incluir y... ¡listo!

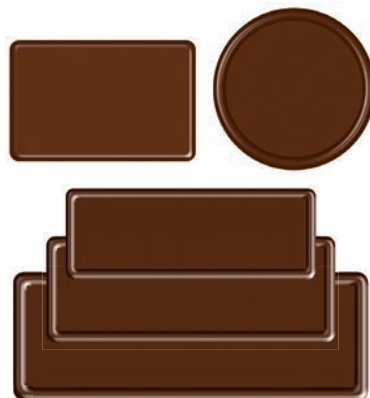

1_TIPO DE CHOCOLATE



2_PEDIDO MÍNIMO

5 paquetes.
Nº de piezas por caja dependiendo del formato.

3_TINTA LOGO

1, 2 ó 3 colores máximo.

4_CLICHÉ

Solo se paga la primera vez.

Cliché gratis en pedidos mínimos:

- 1 tinta: 20 cajas
- 2 tintas: 32 cajas
- 3 tintas: 64 cajas



PLATES · PLAQUES · TARGUETTE · PLACAS

EN: Tell us the size, shape and type of chocolate you prefer. Send us your logo or text that you want to include and... that's it! 1. TYPE OF CHOCOLATE: MILK, WHITE, DARK. 2. MINIMUM ORDER: 5 packages. Number of pieces per box depending on the format. 3. LOGO INK: 1, 2, or 3 colors maximum. 4. CLICHE: You only pay the first time. Free cliché on minimum orders: 1 ink: 20 boxes, 2 inks: 32 boxes, 3 inks: 64 boxes. **FR:** Choisissez la taille, la forme et le type de chocolat que vous préférez. Envoyez-nous votre logo ou le texte que vous souhaitez inclure et... c'est tout ! 1. TYPE DE CHOCOLAT : AU LAIT, BLANC, NOIR. 2. COMMANDE MINIMUM : 5 colis. Nombre de pièces par carton selon format. 3. ENCRE DE LOGO : 1, 2 ou 3 couleurs maximum. 4. CLICHE : Vous ne payez quela première fois. Cliché gratuit sur commande minimum : 1 encre : 20 boîtes, 2 encres : 32 boîtes, 3 encres : 64 boîtes. / **PT:** Diga-nos o tamanho, a forma e o tipo de chocolate que prefere. Envie-nos o seu logótipo ou texto que pretende incluir e... já está! 1. TIPO DE CHOCOLATE: LEITE, BRANCO, PRETO. 2. PEDIDO MÍNIMO: 5 embalagens. Número de peças por caixa em função do formato. 3. TINTA LOGO: 1, 2 ou 3 cores no máximo. 4. CLICHE: Você só paga a primeira vez. Clichê grátis em pedidos mínimos: 1 tinta: 20 caixas, 2 tintas: 32 caixas, 3 tintas: 64 caixas. / **IT:** Dicci la dimensione, la forma e il tipo di cioccolato che preferisci. Inviaci il tuo logo o testo che vuoi includere e... il gioco è fatto! 1. TIPO DI CIOCCOLATO: LATTE, BIANCO, FONDENTE. 2. ORDINE MINIMO: 5 confezioni. Numero di pezzi per scatola a seconda del formato. 3. LOGO INK: 1, 2 o 3 colori massimo. 4. CLICHE: Paghi solo la prima volta. Cliché gratis su ordini minimi: 1 inchiostro: 20 scatole, 2 inchiostri: 32 scatole, 3 inchiostri: 64 scatole.

CHOCOLATE

Chocolate · Chocolat · Cioccolato



FORMATO	MEDIDAS	UDS. ENVASE NORMAL
F17S	Ø 2,4 cm	462 u
F1S	Ø 3 cm	315 u
F314S	Ø 3,9 cm	168 u
F8S	Ø 5 cm	120 u



Format, Measures, Units normal packaging



FORMATO	MEDIDAS	UDS. ENVASE NORMAL
F17S	Ø 2,4 cm	462 u
F1S	Ø 3 cm	315 u
F314S	Ø 3,9 cm	168 u
F8S	Ø 5 cm	120 u



Format, Measures, Units normal packaging



FORMATO	MEDIDAS	UDS. ENVASE NORMAL
F213	3,5 x 2,2 cm	315 u
F7	4,6 x 2,6 cm	210 u
F10	5,5 x 3,5 cm	140 u
F22	4,2 x 3,6 cm	168 u



Format, Measures, Units normal packaging



FORMATO	MEDIDAS	UDS. ENVASE NORMAL
F162S	3,8 x 1,5 cm	392 u
F5S	3,8 x 2,4 cm	294 u
F210S	4 x 2,6 cm	294 u
F125S	5,4 x 2,9 cm	140 u



Format, Measures, Units normal packaging

CHOCOLATE

Chocolate · Chocolat · Cioccolato



F 277 S

FORMATO SURTIDO

Assortment - Assorties

Sortidas - Assortite

2,5 x 1,6 cm · 2 cm · 1,8 x 1,8 cm

Envasado normal: 588 u.



F 278 S

FORMATO SURTIDO

Assortment - Assorties

Sortidas - Assortite

3,7 x 2,4 cm · 2,7 x 2,7 cm · 3 cm

Envasado normal: 315 u.



F 16

4,5 x 4,5 cm

Envasado normal: 144 u.



F 187

7,2 cm

Envasado normal: 56 u.



F 285 S

4 cm

Envasado normal: 196 u.



REF. 545200

3 | LÁMINAS SERIGRAFÍA CHOCOLATE



Obtén tu logo o diseño en láminas de serigrafía para usar directamente sobre chocolate.

1_FORMATO

Caja de 25 láminas de 30 x 40 cm.

2_PEDIDO MÍNIMO

5 cajas.

3_TINTA LOGO

1, 2 ó 3 colores máximo.

4_CLICHÉ

Solo se paga la primera vez.

Cliché gratis en pedidos mínimos:

- 1 tinta: 20 cajas
- 2 tintas: 32 cajas
- 3 tintas: 64 cajas

VÍDEO



Cómo usar hojas de serigrafía de chocolate:
How to use sheets chocolate screen printing:

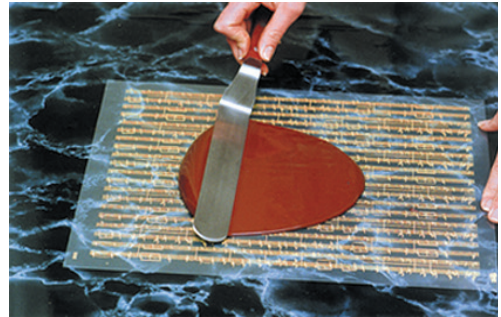

SILK-SCREEN PRINTING · SHEETSLAMES DE SÉRIGRAPHIE · LÁMINAS DE SERIGRAFIA LAMINE DA SERIGRAFIA

EN: Get your logo or design on screen printing sheets to use directly on chocolate. 1.FORMAT: Box of 25 30x40cm sheets. 2. MINIMUM ORDER: 5 boxes. 3.LOGO INK: 1, 2 or 3 colors maximum. 4. CLICHE: You only pay once. Free cliché on minimum orders: 1 ink-20 boxes, 2 inks-32 boxes, 3 inks-64 boxes. / **FR: Obtenez votre logo ou dessin sur des feuilles de sérigraphie à utiliser directement sur le chocolat.** 1.FORMAT : Carton de 25 feuilles 30x40cm. 2. COMMANDE MINIMUM : 5 boîtes. 3. ENCRE LOGO : 1, 2 ou 3 couleurs maximum. 4. CLICHE : Vous ne payez qu'une seule fois. Cliché gratuit sur commande minimum : 1 encre-20 boîtes, 2 encres-32 boîtes, 3 encres-64 boîtes. / **PT: Obtenha seu logotipo ou desenho em folhas de serigrafia para usar diretamente no chocolate.** 1.FORMATO: Caixa com 25 folhas de 30x40cm. 2. PEDIDO MÍNIMO: 5 caixas. 3. TINTA LOGO: 1, 2 ou 3 cores no máximo. 4. CLICHE: Você só paga uma vez. Cliché grátis em pedidos mínimos: 1 tinta-20 caixas, 2 tintas-32 caixas, 3 tintas-64 caixas. / **IT: Ottieni il tuo logo o disegno su fogli serigrafici da utilizzare direttamente sul cioccolato.** 1.FORMATO: Scatola da 25 fogli 30x40cm. 2. ORDINE MINIMO: 5 scatole. 3.LOGO INK: 1, 2 o 3 colori massimo. 4. CLICHE: Pagi solo una volta. Cliché gratis su ordini minimi: 1 inchiostro-20 scatole, 2 inchiostri-32 scatole, 3 inchiostri-64 scatole.

deKora



MATERIA PRIMA Y TEXTURIZANTES

Raw materials and texturizers · Matière première et épaississants
Matéria rima e texturas · Materia prima e testurizzanti

CHOCO DRIP

180 g · 1 u.



401027
CHOCOLATE NEGRO
Dark - Noir
Preto - Nero



401028
CHOCOLATE BLANCO
White - Blanc
Branco - Bianco



401029
ROJO CEREZO
Cherry red - Rouge cerise
Vermelho cereja - Rosso ciliegia

DESCRIPCIÓN: Producto glaseado muy fácil de utilizar para realizar la técnica de decoración conocida como goteo tanto a tartas como semifríos, helados y muchos más productos. MODO DE USO: Se extrae el tapón y se introduce en el microondas a 800 W durante aproximadamente 30 segundos. Una vez que se ha calentado, volver a poner el tapón y agitar vigorosamente para mezclar y unificar el producto. Girar la boquilla del tapón para decorar.

El producto se solidifica rápidamente y no sigue goteando sobre el pastel para un acabado perfecto. Con tapa dosificadora para que el goteo y la conservación sea perfecta.

DESCRIPTION: Easy to use glaze to decorate, through the technique of dripping, cakes, semifreddi, ice cream, and much more. HOW TO USE: Unscrew the cap and put the bottle in the microwave (800 W) for 30 seconds. After heating, screw the cap and shake vigorously in order to mix well the melted product. Unscrew the nozzle and decorate. The product sets quickly and will not continue to drip over the cake, ensuring a perfect finish. With dosing cap for optimal dripping and preservation.

DESCRIPTION: Produit de glaçage très facile à utiliser pour réaliser la technique de décoration connue sous le nom de goutte-à-goutte aussi bien sur des tartes que des entremets glacés, des glaces et bien d'autres produits. MODE D'EMPLOI: Extraire le bouchon et introduire dans le four micro-ondes à 800 W pendant environ 30 secondes. Une fois chauffé, remettre le bouchon et agiter vigoureusement pour mélanger et unifier le produit. Tourner l'embout du bouchon pour décorer.

Le produit se solidifie rapidement et arrête de couler sur le gâteau pour une finition parfaite. Avec un bouchon doseur pour un égouttement et une conservation impeccables.

DESCRIÇÃO: Produto glaseado muito fácil de usar para realizar a técnica de decoração conhecida por "dripping" tanto para tartas como semifríos, gelados e muitos mais produtos. MODO DE UTILIZAÇÃO: Retira-se a tampa e introduz-se no microondas a 800 W durante aproximadamente 30 segundos. Depois de aquecer, volte a colocar a tampa e agite vigorosamente para misturar e unificar o produto. Rode o bocal da tampa para decorar.

O produto solidifica rapidamente e não continua a gotejar sobre o bolo para um acabamento perfeito. Com tampa doseadora para que o gotejar e a conservação sejam perfeitos

DESCRIZIONE: Prodotto di glassa di facile utilizzo per decorare tramite la tecnica del dripping torte, semifreddi, gelati e molto altro ancora. MODALITÀ D'USO: Svitare il tappo e mettere il flacone nel microonde a 800 W per circa 30 secondi. Una volta riscaldato avvitare il tappo e agitare vigorosamente in modo da miscelare bene il prodotto sciolto. Svitare il beccuccio e procedere alla decorazione.

Il prodotto si solidifica rapidamente e non continua a sgocciolare sul dolce, per un effetto perfettamente rifinito. Grazie al tappo dosatore, sia lo sgocciolamento che la conservazione sono perfetti

MATERIA PRIMA

Raw materials · Matière première · Matéria prima · Materia prima

CHOCO DRIP

180 g · 1 u.    



401030
CHOCO DRIP · ROSA
Pink - Rose - Rosa



401031
CHOCO DRIP · AZUL
Blue - Bleu - Azul - Blu



401032
CHOCO DRIP · AMARILLO
Yellow - Jaune - Amarelo - Giallo



401044
CHOCO DRIP · VERDE
Vert - Green - Verde



401042
CHOCO DRIP · ORO PERLADO
Pearl gold - Perle or - Ouro perla - Oro perla



401043
CHOCO DRIP · ORO ROSA
Rose gold - Or rose - Rosa ouro
Oro rosa



MATERIA PRIMA

Raw materials · Matière première · Matéria prima · Materia prima
 CREMA DE AZÚCAR · SUGAR CREAM · CRÉME AU SUCRE · CREME DE AÇÚCAR · CREMA DI ZUCCHERO

ROYAL ICING

PASO A PASO

Step by step - Pas à pas - Passo a passo - Passo dopo passo



Mezclar durante 10 minutos en la batidora a velocidad 2 sin airear el producto, hasta obtener un glaseado blanco y consistente. Instructions: combine for 10 minutes in a mixer set to 2 without aerating the product, until smooth white glaze is obtained. Mode d'emploi: mélanger pendant 10 minutes au mixeur, vitesse 2, sans aérer le produit, jusqu'à l'obtention d'un glaçage blanc homogène. Modo de aplicação: misturar durante 10 minutos na batedeira, na velocidade 2, sem deixar o produto ao ar, até obter um glacé branco e consistente. Mescolare per 10 minuti nel frullatore a velocità 2 senza far prendere aria al prodotto, fino a ottenere una glassa bianca e consistente.

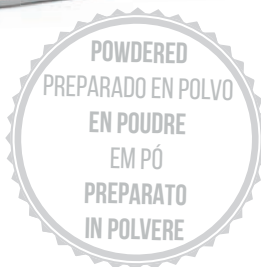

230049

ROYAL ICING

Glasa real · Glaçage royal
 Glacé real · Glassa reale

300 g · 4 u.



DOSIS DE USO: consistencia dura, a 300 g de producto añadir 36 ml de agua. Consistencia media, a 300 g de producto añadir 48 ml de agua. Consistencia suave, a 300 g de producto añadir 72 ml de agua.

USES: for a hard consistency, add 36 ml of water to 300 g of product. For a medium consistency, add 48 ml of water to 300 g of product. For a smooth consistency, add 72 ml of water to 300 g of product.

DOSAGE: pour une consistance dure, ajoutez 36 ml d'eau pour 300 g de produit. Pour une consistance moyenne, ajoutez 48 ml d'eau pour 300 g de produit. Pour une consistance molle, ajoutez 72 ml d'eau pour 300 g de produit.

DOSE RECOMENDADA: para consistência dura, juntar 36 ml de água a 300 g de produto. Para consistência média, juntar 48 ml de água a 300 g de produto. Para consistência suave, juntar 72 ml de água a 300 g de produto.

DOSI D'USO: consistenza dura, per 300 g di prodotto aggiungere 36 ml di acqua. Consistenza media, per 300 g di prodotto aggiungere 48 ml di acqua. Consistenza morbida, per 300 g di prodotto aggiungere 72 ml di acqua.

MATERIA PRIMA

Raw materials · Matière première · Matéria prima · Materia prima
CREMA DE AZÚCAR · SUGAR CREAM · CRÈME AU SUCRE · CREME DE AÇÚCAR · CREMA DI ZUCCHERO

FROSTING EN POLVO

In powder · En poudre · Em pó · In polvere



230044
FROSTING CHOCOLATE
Chocolat - Cioccolato
300 g · 4 u.



230046
FROSTING STRAWBERRY
Fresa - Fraise - Morango
Fragola
300 g · 4 u.



230045
FROSTING VANILLA
Vainilla · Vanille · Baunilha
Vaniglia
300 g · 4 u.



Colocar en un bol y mezclar durante 5 minutos / decora a tu gusto pasteles, magdalenas, galletas, bizcochos... Place in a bowl and mix for 5 minutes / decorate cakes, muffins, cookies and more to your liking Mettre dans un bol puis mélanger pendant 5 minutes / décorez gâteaux, madeleines, biscuits, cakes à votre goût Colocar numa taça e misturar durante 5 minutos / decore ao seu gosto: bolos, queques, bolachas, biscoitos... Posizionare in una ciotola e mescolare per 5 minuti / decora come vuoi torte, madeleine, biscotti, ciambelle...

MATERIA PRIMA

Raw materials · Matière première · Matéria prima · Materia prima
 PASTA DE AZÚCAR · SUGAR PASTE · PÂTE À SUCRE · PASTA DE AÇÚCAR · PASTA DI ZUCCHERO



424141
 Blanco - White
 250 g · 6 u.



NEW **424160**
 Lila - Purple
 250 g · 6 u.



NEW **424161**
 Beige - Nude
 250 g · 6 u.



NEW **424162**
 Naranja - Orange
 250 g · 6 u.



NEW **424163**
 Fucsia - Fuchsia
 250 g · 6 u.



424144
 Negro - Black
 250 g · 6 u.



424145
 Amarillo - Yellow
 250 g · 6 u.

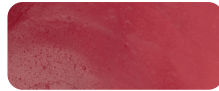

424142
 Rojo - Red
 250 g · 6 u.



424147
 Rosa - Pink
 250 g · 6 u.



424143
 Verde - Green
 250 g · 6 u.



424148
 Marrón - Brown
 250 g · 6 u.



424149
 Azul - Dark blue
 250 g · 6 u.



424146
 Azul - Blue
 250 g · 6 u.



424154
 Blanco - White
 1 kg



424155
 Rosa - Pink
 1 kg



424156
 Rojo - Red
 1 kg



424157
 Negro - Black
 1 kg



424158
 Azul cielo - Blue
 1 kg



MATERIA PRIMA

Raw materials · Matière première · Matéria prima · Materia prima
 PASTA DE AZÚCAR · SUGAR PASTE · PÂTE À SUCRE · PASTA DE AÇÚCAR · PASTA DI ZUCCHERO



100 g

NEW **424159**
FONDANT PACK
 100 g x 6 · 1 u.



424123
PASTA DE AZÚCAR MOLDEABLE COLOR NATURAL
 Natural color shapeable sugar paste
 Pâte de sucre qu'on peut mouler
 Pasta de açúcar moldável cor natural
 Pasta di zucchero modellabile colore naturale
 3 kg



424041
PASTA DE AZÚCAR MOLDEABLE BLANCA
 White shapeable sugar paste
 Pâte de sucre qu'on peut mouler blanc
 Pasta de açúcar moldável branco
 Pasta di zucchero modellabile bianca
 1 kg



PEGAMENTO COMESTIBLE

Edible glue · Colle comestibile · Cola comestível
 Adesivo commestibile



410016
PEGAMENTO
COMESTIBLE
 6 x 40 g



Perfecto para pegar pasta de azúcar.

- Ideal for adhering the sugar paste.
- Idéal pour coller la pâte de sucre.
- Perfeito para colar pasta de açúcar.
- Perfetto per incollare la pasta di zucchero

CMC EN POLVO



424079
 Powder - Poudre
 Pó - Polvere
 4 x 40 g





LACA EN SPRAY BRILLO

Spray brightness lacquer
Laque en spray élat
Laca em spray brilhoso
Lacca spray brillante

430073

300 ml



Ideal para proteger y dar brillo a productos a base de azúcar o chocolate. Se recomienda rociar la superficie a ser decorada con pequeñas pulsaciones. Agitar bien antes de usar.

Ideal to protect surfaces sugar based or chocolate. It is recommended to spray the surface to be decorated with small pulsations. Shake well before using.

Pour protéger et donner briller à surfaces à base de sucre ou de chocolat. Vaporiser la surface à décorer avec de petites pulsations. Bien agiter avant utilisation.

Para proteger e dar brilho a produtos de açúcar com base ou chocolate. Pulverize a superfície a ser decorada com pequenas pulsações. Agitar bem antes de utilizar.

Ideale per proteggere e donare lucentezza ai prodotti a base di zucchero o cioccolato. Si consiglia di spruzzare la superficie da decorare con lievi pressioni. Agitare bene prima dell'uso.



SPRAY DESMOLDANTE

430005

Spray bake non-stick
Anti-adhésif en spray
Desmoldante em spray
Spray sformante

400 ml



Producto para desmoldar: chocolate, fondant, pan, tartas, etc.

Product to release foodstuff preparations from baking pan and mould, etc.

Produit destiné à libérer les préparations alimentaires du moule et des moules, etc.

Produto para desenformar: chocolate, fondant, pão, tortas, etc.

Prodotto per sformare: cioccolata, fondant, pane, torte, ecc.



FRÍO GEL

430025

Cold gel - Froid gel - Frio gel
Gel freddo

400 ml



Cánula larga para un uso preciso.

Long nozzle for precise dispensing

Frío para pegar piezas artísticas de chocolate y caramelo.

Cold to stick artistic pieces of chocolate and caramel.

Froid pour coller des morceaux artistiques de chocolat et de caramel.

Frio para colar pedaços artísticos de chocolate e caramelo.

Freddo per incollare elementi artistici in cioccolato e caramello.

GELATINA EN SPRAY

Gelatina spray · Gélatine en spray · Gelatina spray · Gélatine en spray



430078

200 ml



Gelatina en spray para la decoración de productos alimentarios, en particular para pasteles y tartas. Pulverizar una capa homogénea de producto sobre la superficie a decorar desde una distancia de unos 20-25 cm.

Product for the decoration of food, in particular of pastries and cakes. Spray homogeneous layer of product on the food to be decorated from a distance of about 20-25 cm.

Resto de idiomas, consultar la web / Consulter les langues sur le site web / Consultar idiomas na web / Per le lingue disponibili consultare il sito web.



403005

GELATINA EN HOJAS FINAS CALIDAD ORO

Gelatine sheets gold quality - Gélatine en feuilles fines qualité or - Gelatina em folhas finas qualidade oro - Gelatina in fogli sottili di qualità oro

1 kg



deKora

YouTube

Escanea este código QR

EN: Scan this QR code.
FR: Scannez ce code QR.
PT: Digitalize este código QR.
IT: Scannerizza questo codice QR

403013

GELATINA EN POLVO CALIDAD ORO

Powdered gelatine gold quality
Gélatine en poudre fines qualité or
Gelatina em pó qualidade oro
Gelatina in polvere di qualità oro

1 kg



424031

GEL DE SÍLICE

Silica gel
Gel di silice

100 x 5 g



ÁCIDOS

Acids · Acides · Ácidos · Acidi



410017

ÁCIDO CÍTRICO

Citric acid - Acide citrique - Ácido cítrico - Acido citrico

400 g



Propiedades: Regulador de la acidez y conservador.
 Modo de uso: Directamente sobre el producto y remover.
 Aplicación: Controla la acidez o alcalinidad de un producto alimenticio.
 Solubilidad: Soluble en líquidos.
 Dosificación: 1-10 g/ kg según aplicación.
 Elaboraciones: En golosinas, mermeladas, frutas, gelatinas, etc.



Properties: Acidity regulator and preservative.
 How to use: Directly in the product and stir.
 Application: Controls the acidity or alkalinity of a food product.
 Solubility: Soluble in liquids.
 Dosage: 1-10 g/kg depending on application.
 Production of: Sweets, jams, fruits, gelatine, etc.



410018

ÁCIDO TARTÁRICO

Tartaric acid - Acide tartrique - Ácido tartárico - Acido tartarico

400 g



Propiedades: Acidulante y conservante natural.
 Modo de uso: Directamente sobre el producto y remover.
 Aplicación: Prolonga la vida útil de los alimentos protegiéndolos del deterioro causado por microorganismos, incrementan la acidez de un producto alimenticio o le confieren un sabor ácido, o ambas cosas.
 Solubilidad: Soluble en líquidos.
 Dosificación: 1 g/ kg según aplicación.
 Elaboraciones: Como conservante natural para mermeladas, helados, gelatinas, conservas, bebidas. En los mostos y vinos se emplea para elaborar vinos más equilibrados desde el punto de vista gustativo.



Properties: Acidulant and natural preservative.
 How to use: Directly in the product and stir.
 Application: Prolongs a food's shelf life by protecting it from the deterioration caused by microorganisms, and increases the acidity of a food product or gives it an acidic flavour, or both.
 Solubility: Soluble in liquids.
 Dosage: 1 g/kg depending on application.
 Production of: As a natural preservative in jams, ice creams, gelatine, preserves, drinks. In musts and wines it is used to produce wines that are more balanced in terms of their taste.



Resto de idiomas, consultar la web / Consulter les langues sur le site web / Consultar idiomas na web / Per le lingue disponibili consultare il sito web.

TEXTURIZANTES

Texturizers · Épaississants · Texturas · Testurizzanti



410019

ÁCIDO ASCÓRBICO

Ascorbic acid - Acide ascorbique -
Ácido ascórbico - Acido ascorbico

 400 g



Propiedades: Conservador, acidulante y antioxidante.
Modo de uso: Directamente sobre el producto y remover.
Aplicación: Prolonga la vida útil de los alimentos protegiéndolos del deterioro causado por la oxidación, incrementan la acidez de un producto alimenticio o le confieren un sabor ácido, o ambas cosas. prolongan la vida útil de los alimentos protegiéndolos del deterioro causado por microorganismos o que protegen del crecimiento de microorganismos patógenos.
Solubilidad: Soluble en líquidos.
Dosificación: 0,05 g/l según aplicación.
Elaboraciones: En golosinas, mermeladas, frutas, gelatinas, etc.



Properties: Preservative, acidulant and antioxidant. How to use: Directly in the product and stir.
Application: Prolongs a food's shelf life by protecting it from the deterioration caused by oxidation, and increases the acidity of a food product or gives it an acidic flavour, or both. Prolongs a food's shelf life by protecting it from the deterioration caused by microorganisms.
Solubility: Soluble in liquids.
Dosage: 0,05 g/l depending on application.
Production of: Mix where oxidation needs to be avoided, fruit salads, juices, etc.

ESPESANTES

Thickening agents · Épaississants · Espessantes · Addensanti



Ref. 410022

GOMA GUAR

Guar gum - Gomme de guar -
Goma de guar - Gomma guar

 300 g



Propiedades: Espesante.
Modo de uso: Se presenta en forma de polvo que diluiremos en agua (ya sea fría o caliente) para obtener una salsa o una sopa espesa.
Aplicación: Sustancia que aumenta la viscosidad de un alimento.
Solubilidad: Soluble en líquidos fríos o calientes.
Dosificación: 3-5 g/Kg según aplicación.
Elaboraciones: Helados, repostería y salsas.



Properties: Thickener.
How to use: It comes in powder form that we will dilute in water (either hot or cold)
Application: substance that increases a food's viscosity.
Solubility: Completely soluble in hot water.
Dosage: 3-5 g/kg depending on application.
Production of: Ice cream, baking and sauces.



Resto de idiomas, consultar la web / Consulter les langues sur le site web / Consultar idiomas na web / Per le lingue disponibili consultare il sito web.

TEXTURIZANTES

Texturizers · Épaississants · Texturas · Testurizzanti



410023

GOMA ARÁBIGA

Gum arabic - Gomme d'arabiga
Goma-arábica - Gomma arabica

 300 g



Propiedades: Espesante.

Modo de uso: Se presenta en forma de polvo que diluiremos en agua ya sea fría o caliente.

Aplicación: Sustancia que aumenta la viscosidad de un alimento.

Solubilidad: Soluble en líquidos fríos o calientes.

Dosificación: 2-10 g/ kg según aplicación.

Elaboraciones: Elaboraciones: Gominolas, marshmallows, repostería y confitería.



Properties: Thickener.

How to use: It comes in powder form that we will dilute in water (either hot or cold)

Application: Substance that increases a food's viscosity.

Solubility: Completely soluble in hot water.

Dosage: 2-10 g/kg depending on application.

Production of: Jellybeans, marshmallows, pastries and confectionery.



410025

GOMA XANTANA

Xanthan gum - Gomme xhantane
Goma xantana - Gomma di xantano

 300 g



Propiedades: Espesante.

Modo de uso: Se presenta en forma de polvo que diluiremos en agua ya sea fría o caliente.

Aplicación: Sustancia que aumenta la viscosidad de un alimento.

Solubilidad: Soluble en líquidos fríos o calientes.

Dosificación: 2-10 g/kg según aplicación.

Elaboraciones: Rellenos para pastelerías, emulsiones saborizantes, aderezos, productos lácteos, salsas, confitería, jarabes, etc.



Properties: Thickener.

How to use: It comes in powder form that we will dilute in water (either hot or cold).

Application: Substance that increases a food's viscosity.

Solubility: Completely soluble in hot water.

Dosage: 2-10 g/kg depending on application.

Production of: Fillings for cakes, flavour emulsions, dressings, dairy products, sauces, confectionery, syrups, etc.



Resto de idiomas, consultar la web / Consulter les langues sur le site web / Consultar idiomas na web / Per le lingue disponibili consultare il sito web.

TEXTURIZANTES

Texturizers · Épaississants · Texturas · Testurizzanti

GELIFICANTES

Gelling agents · Gélifiants · Gelificantes · Gelificanti



410020
ALGINATO
Alginate - Alginate - Alginate
300 g



 Propiedades: Gelificante/espesante. Modo de uso: Aplicar directamente sobre el producto y mezclar bien con la ayuda de un batidor eléctrico para homogeneizar bien la mezcla. Aplicación: Sustancia que da textura a un producto alimenticio mediante la formación de un gel / Sustancia que aumenta la viscosidad de un alimento. Indicaciones: actúa como gelificante cuando interactúa con medios cálcicos. En helados ayuda a controlar la formación de cristales de hielo, aumenta el volumen y retarda el descongelamiento, además de ofrecer una sensación suave y tersa en boca. Solubilidad: Soluble en líquidos. Dosificación: 5 g/ Kg Elaboraciones: Esferificación, espumas, aires, espesados, geles irreversibles en agua fría.

 Properties: Gelling/thickener. Apply directly to the product and mix well with the help of an electric hand mixer to thoroughly mix the mixture. Application: Substance that gives a food product texture by forming a gel / Substance that increases a food's viscosity. Indications: Acts as a gelling agent when it interacts with calcium means. In ice cream it helps to control the formation of ice crystals, increases the volume and delays defrosting, besides offering a soft and smooth sensation in the mouth. Solubility: Soluble in liquids. Dosage: 5 g/kg Production of: Spherification, foams, air, thickening, irreversible gels in cold water.



410024
PECTINA LM
300 g



 Pectina LM (bajo metoxilo) forma geles untables, brillantes y confieren al gel características de elevada untabilidad y brillante, son termo-reversibles tanto en caliente como en frío. Para elaboraciones con concentraciones de azúcar (sacarosa) muy altas, se debe trabajar con un PH inferior a 3,5 pues de lo contrario el producto tiende a empanizarse (granillo blanquecino) Para evitar la empanización se recomienda trabajar con pH 3,2 a ácido a la mezcla por ejemplo ácido cítrico. Modo de uso: Mezclar bien la pectina con el azúcar y con la mermelada a fuego lento hasta conseguir la textura deseada. Las mermeladas necesitan un ácido para gelificar mejor, por lo tanto es importante añadir un ácido a la mezcla, por ejemplo, ácido cítrico. Aplicación: Sustancia que da textura a un producto alimenticio mediante la formación de un gel. Solubilidad: Soluble en líquidos llevados a ebullición. Dosificación: 15 g/kg de pulpa. Elaboraciones: Adecuado para la fabricación de gelatinas, productos de pastelería y repostería.

 They form glossy, spreadable gels and give the gel characteristics of high spreadability and shine. They are also thermo-reversible in both hot and cold temperatures. To produce using very high sugar (sucrose) concentrations, work with a pH of less than 3.5, to avoid the product having a coated appearance with white granules. To avoid the coating, it is recommended to work within a pH range of 3.2 - 3.5 or failing that at pH 3.5. Properties: gelling. How to use: Mix the pectin well with the sugar and mix with the jam over low heat until the desired texture is achieved. The jams need an acid for a greater gelation so it is important to add an acid such as citric acid to the mixture. Application: Substance that gives a food product texture by forming a gel. Solubility: Soluble in liquids brought to the boil. Dosage: 15 g/kg of pulp. Production of: Suitable for the production of gelatine, bakery and confectionary products.

 Resto de idiomas, consultar la web / Consulter les langues sur le site web / Consultar idiomas na web / Per le lingue disponibili consultare il sito web.

TEXTURIZANTES

Texturizers · Épaississants · Texturas · Testurizzanti

UTENSILIOS · TOOLS · OUTILLAGE · UTENSÍLIOS



** 100 ml mezcla
Mixture / Mélange



Cazo
Saucepan



Ref: 410021
1 g Ágar ágar



Aceite vegetal
Vegetable oil / Huile végétale / Azeite vegetal



Ref: 535003



Ref: 535330



Agua de botella
Bottle water / Eau en bouteille / Água da garrafa

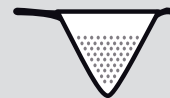

** **ES.** Zumo de frutos rojos (elegir la mezcla líquida a esferificar al gusto pH ≥ 3). **EN.** Red berries juice (choose the liquid mixture to spherify to your liking pH ≥ 3). **FR.** Jus de fruits rouges (choisir le mélange liquide à sphérifier selon votre goût pH ≥ 3). **PT.** Sumo de frutos vermelhos (escolher a mistura líquida a esferificar conforme o gosto pH ≥ 3). **IT.** Succo di frutti rossi (scegliere la miscela liquida ed effettuare la sferificazione a proprio gusto pH ≥ 3).

PASO A PASO · STEP BY STEP · PAS À PAS · PASSO A PASSO

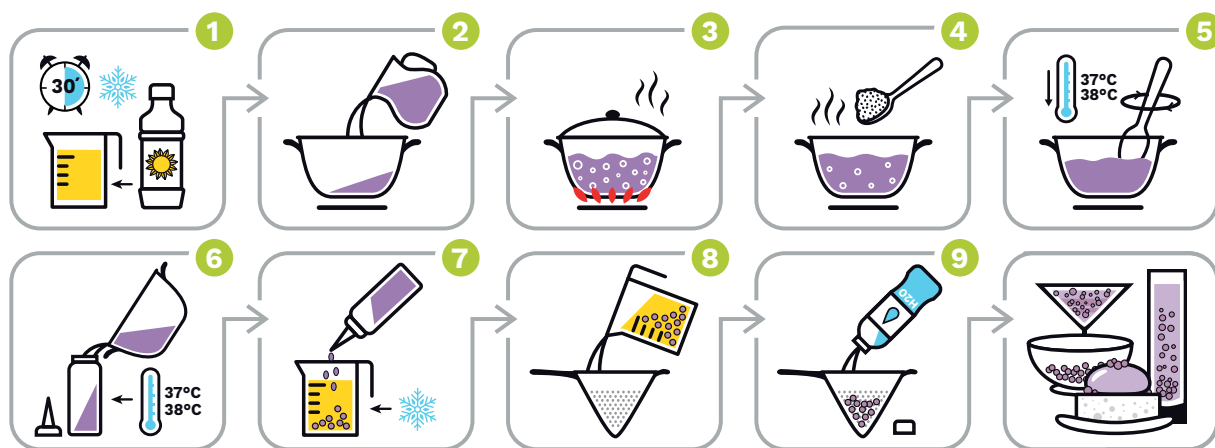

1 **ES.** Congelar o refrigerar durante 30' previamente. **EN.** reeze or refrigerate for 30' beforehand. **FR.** Congeler ou placer préalablement au réfrigérateur durant 30'. **PT.** Congelar ou refrigerar durante 30 segundos antes. **IT.** Surgelare o conservare refrigerato 30' prima. 2 **ES.** Mezcla el producto a esferificar (elegir al gusto). **EN.** Mix or product to spherify (choose to your liking). **FR.** Mélange ou produit à sphérifier (au choix). **PT.** Mistura ou produto a esferificar (escolher conforme o gosto). **IT.** Miscelare il prodotto da sterificare (scegliere a proprio gusto) 3 **ES.** Llevar a ebullición. **EN.** Bring to the boil. **FR.** Porter à ébullition. **PT.** Deixar ferver. **IT.** Portare a ebollizione. 4 **ES.** Añadir 1 g ágar ágar. **EN.** To add 1 g ágar ágar. **FR.** Ajouter 1 g ágar ágar. **PT.** Adicionar 1 g ágar ágar. **IT.** Aggiungere 1 g di ágar ágar. 5 **ES.** Remover bien, una vez el producto este integrado, dejar reposar hasta conseguir 37–38°C. **EN.** Stir well, once the product is integrated, let it rest until you get 37–38°C. **FR.** Une fois le produit ajouté, bien remuer, laisser reposer jusqu'à obtenir 37–38°C. **PT.** Remover bem, uma vez que o produto está impregnado, deixar repousar até conseguir 37–38°C. **IT.** Mescolare con attenzione, una volta ben miscelato il prodotto, lasciar riposare fino a condurre a una temperatura pari a 37–38°C 6 **ES.** Verter la mezcla a 37–38°C. **EN.** Pour the mixture at 37–38°C. **FR.** Verser le mélange à 37–38°C. **PT.** Derramar a mistura a 37–38°C. **IT.** Versare la miscela a 37–38°C 7 **ES.** dejar caer gotitas lentamente. **EN.** drop droplets slowly. **FR.** faire tomber doucement des gouttelettes. **PT.** deixar cair pequenas gotas lentamente. **IT.** Far gocciolare lentamente. 8 **ES.** Colar el contenido de la jarra. **EN.** Strain the contents of the jar. **FR.** Filtrer le contenu du récipient. **PT.** Colar o conteúdo da jarra. **IT.** Scolare il contenuto della brocca. 9 **ES.** Enjuagar con agua de botella. **EN.** Rinse with bottled water. **FR.** Rincer à l'aide d'eau en bouteille. **PT.** Enxaguar com água da garrafa. **IT.** Risciacquare la bottiglia con acqua

RECOMENDACIONES · RECOMMENDATIONS · CONSEILS · RECOMENDAÇÕES · RACCOMANDAZIONI

ES. Usar siempre un recipiente alto para dejar caer las gotitas. **EN.** Always use a tall container for the drops to fall into. **FR.** Toujours utiliser un récipient haut pour laisser tomber les gouttelettes. **PT.** Utilizar sempre um recipiente alto para deixar cair as gotinhas. **IT.** Servirsi sempre di un recipiente alto per lo sgocciolamento. **ES.** Para mezclas dulces, se recomienda usar aceite de girasol, para que no adquieran sabor. Estas perlas se pueden usar para diversas elaboraciones, como decorar tartas, acompañar platos, salsas, incluso dentro de algún coctel, o ensaladas. **EN.** For sweet mixtures, it is recommended to use sunflower oil, so that they do not acquire flavour. These pearls can be used for various preparations, such as decorating cakes, accompanying dishes, sauces, even in a cocktail, or salads. **FR.** Pour des mélanges sucrés, il est conseillé d'utiliser de l'huile de tournesol, afin d'éviter qu'elle prennent le goût des aliments. Ces perles peuvent être utilisées dans différentes recettes, en guise de décoration pour les pâtisseries, pour accompagner plats et sauces, et même dans un cocktail ou des salades. **PT.** Para misturas doces, recomenda-se utilizar óleo de girassol, para que não adquiram sabor. Estes pérolas podem ser utilizadas em várias elaborações, como decorar tartes, acompanhar pratos, molhos, inclusive dentro de cocktails ou saladas. **IT.** Per miscele dolci, si consiglia di utilizzare l'olio di girasole per non alterare sapore al prodotto. Queste perle possono essere utilizzate in diverse lavorazioni, per esempio per la decorazione di torte e piatti, salse e persino all'interno di alcuni cocktail o insalate.

TEXTURIZANTES

Texturizers · Épaississants · Texturas · Testurizzanti



410021
ÁGAR - ÁGAR

 400 g



Propiedades: Gelificante.

Modo de uso: El agar-agar al estar en polvo, se debe de mezclar con la preparación que deseemos espesar y/o gelificar y disolvemos en un líquido para que pueda empezar a funcionar.

Aplicación: Sustancia que da textura a un producto alimenticio mediante la formación de un gel.

Solubilidad: Soluble en agua en ebullición.

Dosificación: 1-10 g/kg según aplicación.

Elaboraciones: En golosinas, mermeladas, frutas, gelatinas, etc.

 **Properties:** Gelling. **How to use:** When agar-agar is a powder, it must be mixed with the preparation we want to thicken and/or gel, and dissolve it in a liquid so that it can begin to take effect. **Application:** Substance that gives a food product texture by forming a gel. **Solubility:** Soluble in boiling water. **Dosage:** 1-10 g/kg depending on application. **Production of:** Sweets, jams, fruits, gelatine, etc.

 **Propriétés:** Gélifiant. **Mode d'utilisation:** L'agar-agar étant en poudre, il doit être mélangé à la préparation que nous souhaitons épaissir et/ou gélifier, et nous le dissolvons en liquide pour pouvoir commencer à fonctionner. **Application:** Substance qui apporte de la texture à un produit alimentaire par la formation d'un gel. **Solubilité:** Soluble dans de l'eau en ébullition. **Dosage:** 1-10 g/kg selon l'application. **Élaborations:** Dans des bonbons, des confitures, des fruits, des gélatines, etc.

 **Propriedades:** Gelificante. **Modo de utilização:** O ágar-ágar ao estar em pó, deve ser misturado com a preparação que queremos espessar e/ou gelificar e disolvemos num líquido para que possa começar a funcionar. **Aplicação:** Substância que dá textura a um produto alimentar através da formação de um gel. **Solubilidade:** Solúvel em água em ebulição. **Dosagem:** 1-10 g/kg, dependendo da aplicação. **Elaborações:** Em doces, compotas, frutas, gelatinas, etc.

 **Proprietà:** Gelificante. **Modalità d'uso:** L'agar-agar si presenta in polvere e deve essere dunque miscelato con il preparato da addensare e/o gelificare, dissolvendolo in un liquido perché possa iniziare a funzionare. **Applicazione:** Sostanza che migliora la consistenza degli alimenti attraverso la formazione di un gel. **Solubilità:** Solubile in acqua bollente. **Dosaggio:** 1-10 g/kg a seconda dell'applicazione. **Elaborazioni:** Caramelle, marmellate, frutta, gelatine, ecc.

AZÚCARES GRANULADOS

Granulated sugars · Sucres granulés · Açúcares granulados · Zuccheri granulati



424138
FRUCTOSA
Fructose - Fruttosio
400 g



424034
GLUCOSA 44
Glucose - Glicose
Glucosio
5 kg



Propiedades: Edulcorante.

Modo de uso: Aplicar directamente sobre el producto y remover.

Aplicación: Sustancia que se emplea para dar sabor dulce a los alimentos.

Solubilidad: Soluble en líquidos.

Elaboraciones: Repostería, confitería, golosinas, etc (a cualquier producto que se quiera endulzar).

 Properties: Sweetener

How to use: Apply directly in the product and stir.

Application: Substance that is used to give food a sweet flavour.

Solubility: Soluble in liquids.

Production of: pastries, confectionary products, sweets... etc. (any product that you want to sweeten).

 Propriétés: Édulcorant.

Mode d'utilisation: Appliquer directement sur le produit et retirer.

Application: Substance utilisée pour donner un goût sucré aux aliments.

Solubilité: Solubilité en liquides.

Élaborations: Pâtisserie, confiserie, bonbons, etc. (à n'importe quel produit que l'on souhaite sucrer).

 Propriedades: Edulcorante.

Modo de utilização: Aplicar diretamente no produto e remover.

Aplicação: Substância que é usada para dar um sabor doce aos alimentos.

Solubilidade: Solúvel em líquidos a ferver.

Elaborações: Pastelaria, confeitaria, doces, etc.(para qualquer produto que se queira adoçar).

 Proprietà: Edulcorante.

Modalità d'uso: Applicare direttamente sul prodotto e mescolare.

Applicazione: Sostanza che conferisce un sapore dolce agli alimenti.

Solubilità: Solubile nei liquidi

Elaboraciones: pasticceria, confetteria, caramelle, ecc. (comprende qualsiasi prodotto si desideri addolcire)

Modo de uso: Aplicar directamente sobre el producto y remover.

Aplicación: Sustancia que se emplea para dar sabor dulce a los alimentos.

Solubilidad: Soluble en líquidos.

Elaboraciones: Repostería, confitería, golosinas, etc (a cualquier producto que se quiera endulzar)

 How to use: Apply directly in the product and stir.

Application: Substance that is used to give food a sweet flavour.

Solubility: Soluble in liquids.
Production of: Pastries, confectionary products, sweets... etc. (any product that you want to sweeten).

 Mode d'utilisation: Appliquer directement sur le produit et retirer.

Application: Substance utilisée pour donner un goût sucré aux aliments.

Solubilité: Solubilité en liquides.
Élaborations: Pâtisserie, confiserie, bonbons, etc. (à n'importe quel produit que l'on souhaite sucrer).

 Modo de utilização: Aplicar diretamente no produto e remover.

Aplicação: Substância que é usada para dar um sabor doce aos alimentos.

Solubilidade: Solúvel em líquidos.
Elaborações: Pastelaria, confeitaria, doces, etc.(para qualquer produto que se queira adoçar).

 Modalità d'uso: Applicare direttamente sul prodotto e mescolare.

Applicazione: sostanza che conferisce un sapore dolce agli alimenti.

Solubilità: Solubile nei liquidi.
Lavorazioni: pasticceria, confetteria, caramelle, ecc. (comprende qualsiasi prodotto si desideri addolcire)

TEXTURIZANTES

Texturizers · Épaississants · Texturas · Testurizzanti



424032

ISOMALT TEXTURA GRUESA

Thick texture - Texture grosse - Textura grossa - Isomalt consistenza grossa

5 kg



Propiedades: Edulcorante.

Modo de uso: Aplicar directamente sobre el producto y remover.

Aplicación: Para trabajos de caramelo, utilizar directamente, dejar alcanzar textura deseada. Admite colorantes líquidos y en polvo.

Solubilidad: Soluble en líquidos.

Elaboraciones: Decoraciones caramelo, figuras caramelo, caramelo soplado.



Properties: Sweetener. How to use: Apply directly in the product and stir.

Application: For sweets, use directly, let them reach desired texture, it can take liquid and powder dyes. Solubility: Soluble in liquids. Production of: Candy decorations, candy figures, blown sugar.



Propriétés: Édulcorant. Mode d'utilisation: Appliquer directement sur le produit et retirer. Application: Pour le travail du caramelo, utiliser directement jusqu'à obtention de la texture souhaitée. Admet les colorants liquides et en poudre. Solubilité: Solubilité en liquides. Élaborations: Décorations en caramelo, figures en caramelo, caramelo soufflé.



Propriedades: Edulcorante. Modo de utilização: Aplicar diretamente no produto e remover. Aplicação: Para trabalhos de caramelo, usar diretamente, deixar atingir a textura pretendida, pode levar colorantes líquidos e em pó. Solubilidade: Solúvel em líquidos. Elaboraões: Decoraões com caramelo, figuras com caramelo, caramelosoprado.



Proprietà: Edulcorante. Modalità d'uso: Applicare direttamente sul prodotto e mescolare. Applicazione: Per lavorazioni in caramello, utilizzare direttamente, lasciare che il prodotto raggiunga la consistenza desiderata. Compatibile con coloranti liquidi e in polvere. Solubilità: Solubile nei liquidi. Lavorazioni: Decorazioni in caramello, sagome in caramello, caramello soffiato.

AZÚCAR LÍQUIDO

Liquid sugar · Sucre liquide · Açúcar líquido · Zucchero liquido



NEW

410026

600 g



Mejora la textura. Proporciona un mejor sabor. Aumenta la vida útil. Facilita la cocción. Mejora la retención de humedad. Estabiliza la masa. Reduce la cristalización. Ayuda a reducir la formación de cristales de hielo. Proporciona una textura más suave. Aumenta la estabilidad. Ayuda a prevenir la resequeidad.



Improves texture. Provides a better taste. Increases the useful life. Makes cooking easier. Improves moisture retention Stabilizes the dough. Reduces crystallization. Helps reduce the formation of ice crystals. Provides a smoother texture Increases stability. Helps prevent dryness.



Améliore la texture. Fournit un meilleur goût. Augmente la durée de vie utile Facilite la cuisson. Améliore la rétention d'humidité Stabilise la pâte. Réduit la cristallisation. Aide à réduire la formation de cristaux de glace. Fournit une texture plus lisse. Augmente la stabilité. Aide à prévenir le dessèchement.



Melhora a textura. Proporciona um sabor melhor Aumenta a vida útil. Torna o cozimento mais fácil. Melhora a retenção de umidade. Estabiliza a massa. Reduz a cristalização. Ajuda a reduzir a formação de cristais de gelo. Proporciona uma textura mais suave. Aumenta a estabilidade. Ajuda a prevenir o ressecamento





Migliora la consistenza. Fornisce un gusto migliore Aumenta la vita utile. Facilita la cottura. Migliora la ritenzione dell'umidità. Stabilizza l'impasto. Riduce la cristallizzazione. Aiuta a ridurre la formazione di cristalli di ghiaccio. Fornisce una consistenza più liscia. Aumenta la stabilità. Aiuta a prevenire la secchezza.

AZÚCAR ANTIHUMEDAD

Sugar antihumidity · Sucre antihumidité · Açúcar anti-umidade · Zucchero antiumidità

- No se disuelve y permanece intacto sobre las tartas, incluso en contacto con humedad.
- Para decorar tartas, donuts, cupcakes y mucho más.
- Colores: Azul, rosa y oro perlados.

-  - It does not dissolve and remains intact on cakes, even if in contact with humidity.
- To decorate cakes, donuts, cupcakes and much more.
- Colours: Blue, pink and gold in the pearled version.

-  - Não se dissolve e permanece intacto nos bolos, mesmo em contato com a umidade.
- Para decorar bolos, donuts, cupcakes e muito mais.
- Cores: Azul, rosa e dourado na versão perlada.

-  - Il ne se dissout pas et reste intact sur les gâteaux, même en contact avec l'humidité.
- Pour décorer des gâteaux, des beignets, des cupcakes et bien plus encore.
- Couleurs : Bleu, rose et doré dans la version nacrée.

-  - Non si dissolve e rimane intatto sulle torte, anche a contatto con l'umidità.
- Per decorare torte, ciambelle, cupcakes e molto altro.
- Colori: Blu, rosa e oro nella versione perlata.



NEW **445089**
AZUL CIELO PERLADO
 Pearl sky blue
 Perlé bleu ciel
 Azul céu perlado
 Azzurro perlato
 25 g



NEW **445087**
ORO PERLADO
 Pearl gold
 Perlé or
 Dourado perlado
 Oro perlato
 25 g



NEW **445088**
ROSA PERLADO
 Pearl pink
 Perlé rose
 Rosa perlado
 Rosa perlato
 25 g



TEXTURIZANTES

Texturizers · Épaississants · Texturas · Testurizzanti

AROMAS EN PASTA

Food flavors in paste · Arômes alimentaires en pâte · Aromas alimentares em pasta
Aromi alimentari in pasta



NEW 60 ml · 4u.







- Los aromas alimentarios en pasta son ideales para aromatizar bizcochos, cremas, frosting, cupcakes, fondant, galletas.
- Además, también están indicados para preparaciones en frío como helados, batidos, granizados.
- Los aromas en pasta son saborizantes que aportan color además de sabor a nuestras preparaciones, ya que en su formulación contienen colorantes, excepto el aroma de coco.
- La dosificación de estos aromas es de +/- 4-7 g por kg de masa, se recomienda añadir el aroma en la última fase de preparación de nuestra receta.

-  - Food flavors in paste are ideal for flavoring cakes, creams, frosting, cupcakes, fondant, cookies.
- They are also suitable for cold preparations such as ice cream, milkshakes, slushies.
- The paste flavors are flavorings that add color as well as flavor to our preparations, as they contain colorants in their formulation, except for the coconut flavor.
- The recommended dosage for these flavors is +/- 4-7 grams per kilogram of dough. It is recommended to add the flavor in the last phase of preparing our recipe.

APTOS PARA VEGANOS:

Suitables for vegans - Convient aux végétaliens - Adequado para veganos - Adatto ai vegani.

 Resto de idiomas, consultar la web / Consulter les langues sur le site web / Consultar idiomas na web / Per le lingue disponibili consultare il sito web.

-  **410027**
NARANJA
Orange
-  **410028**
LIMÓN
Lemon
-  **410029**
FRESA
Strawberry
-  **410030**
FRAMBUESA
Raspberry
-  **410031**
RED VELVET
Red velvet
-  **410032**
VAINILLA
Vanilla
-  **410033**
COCO
Coconut 
-  **410034**
VIOLETAS
Violets



Gama Oro Gourmet

Gourmet gold range

Un toque de lujo a tus elaboraciones **A touch of luxury to your elaborations**

Todos los productos OroGourmet son comestibles y disponen de los Registros Sanitarios exigidos tanto en la Unión Europea como en Estados Unidos, así como el certificado Kasher de alimentación. **OroGourmet se produce a partir de oro de 24 quilates según la normativa europea.** Tiene múltiples aplicaciones y se funde en el paladar sin alterar el sabor ni aroma natural de los alimentos.

All OroGourmet products are edible and have the Sanitary Registries required both in the European Union and in the United States, as well as the Kosher food certificate. **OroGourmet is produced from 24 carat gold according to European regulations.** It has multiple applications and melts on the palate without altering the natural flavor or aroma of food.



CONFORME
NORMATIVA UE
COMPLIES TO EU
REGULATION



FABRICADO
EN ALEMANIA
MADE IN
GERMANY



CERTIFICADO
KOSHER
KOSHER
CERTIFICATE



IDÓNEO HALAL
HALAL SUITABLE



SIN GLUTEN
GLUTEN FREE



ORO
RESPONSABLE
RESPONSIBLE
GOLD



CERTIFICADO
HACCP
HACCP
CERTIFICATE

APTOS PARA VEGANOS
SUITABLES FOR VEGANS



VOIR LA VERSION
FRANÇAISE



VER VERSÃO
EM PORTUGUÊS



VEDI VERSIONE
IN ITALIANO

TEXTURIZANTES

Texturizers · Épaississants · Texturas · Testurizzanti

SHABIN



401052
SHABIN
ORO/GOLD
1 g



401062
SHABIN
PLATA/SILVER
1 g

DOSIFICADORES COPOS

Shakers flakes



401063
DOSIFICADORES
METACRILATO COPOS ORO
Methacrylate shaker gold flakes
100 mg



401064
DOSIFICADORES
METACRILATO COPOS PLATA
Methacrylate shaker silver flakes
200 mg

FILAMENTOS

Filaments



401055
FILAMENTO FINO
ORO
Thin gold filament
300 mg



401056
FILAMENTO GRUESO
ORO
Thick gold filament
300 mg



TEXTURIZANTES

Texturizers · Épaississants · Texturas · Testurizzanti

POLVO

Powder



401048
POLVO ORO
Gold powder
1 g

401049
POLVO ORO
Gold powder
300 mg



401060
POLVO
PLATA
Silver powder
1 g



401066
DOSIFICADOR
METÁLICO POLVO
Stainless Steel Shaker
for powder

COPOS

Flakes



401050
COPOS ORO
Gold flakes
1 g

401051
COPOS ORO
Gold flakes
300 mg



401061
COPOS PLATA
Silver flakes
1 g



401065
DOSIFICADOR
METÁLICO COPOS
Stainless Steel Shaker
for flakes

QUADRATUS

401053
QUADRATUS ORO
Gold quadratus
300 mg



CORAZONES

Hearts

401054
CORAZONES ORO
Gold hearts
300 mg



LÁMINAS COMESTIBLES

Edible leaves



401045
LÁMINAS ORO
Gold leaves
8 x 8 cm · 25 u.



401047
LÁMINAS ORO
Gold leaves
5 x 5 cm · 24 u.



401046
LÁMINAS TRANSFER
ORO
Gold transfer leaves
8 x 8 cm · 25 u.



401059
LÁMINAS PLATA
Silver leaves
8 x 8 cm · 25 u.



401067
TAPA DOSIFICADORA
Dosing cap



401068
BROCHA
Acrylic brush





Premium Set

401058



SHABIN
300 mg



POLVO*
Powder
300mg



COPOS*
Flakes
300 mg



QUADRATUS*
300 mg



CORAZONES*
Hearts
300 mg



PINZAS
Tweezers



* Compatible



TAPA
DOSIFICADORA
Dosing cap



FILAMENTOS
FINOS*
Thin gold filament
300 mg



FILAMENTOS
GRUESOS*
Thick gold filament
300 mg



BROCHA
Acrylic brush



LÁMINAS ORO
Gold leaves
8 x 8 cm · 25 u.



LÁMINAS TRANSFER ORO
Gold transfer leaves
8 x 8 cm · 25 u.



MATERIA PRIMA

Raw materials · Matière première · Matéria prima · Materia prima

macarons

de PARIS

402003

NATURAL, CHOCOLATE, PISTACHO Y FRESA

Natural, chocolate, pistachio and strawberry

Naturel, chocolat, pistache et fraise

Natural, chocolate, pistachio e morango

Naturale, cioccolato, pistacchio e fragola

Ø 3,5 cm · 160 u.



deKora

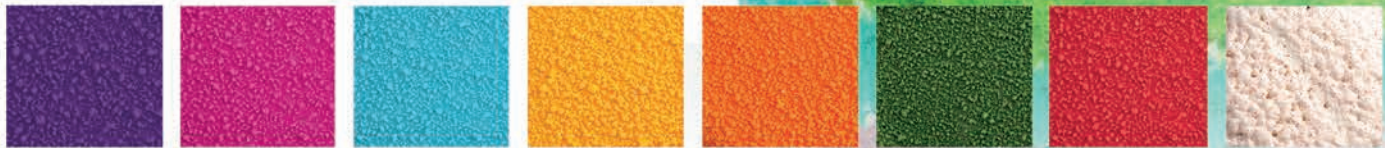

COLORANTES

Colourings · Colorants · Colorantes · Coloranti

COLORANTES

Colourings · Colorants · Colorantes · Coloranti

ROTULADORES PARA DECORAR

Decorating marking pens · Feutres pour décorer · Marca-textos para decorar
Pennarello per decorare



Modo de uso
How to use
Comment l'utiliser
Como utilizar
Come si usa



NEW

414108 ROTULADOR ORO

Gold edible marker.
Marcador comestível dourado.
Marqueur or comestible.
Pennarello commestibile oro.

12 x 12 x 4 u



414094 2 ROTULADORES NEGROS

2 black pastry pens
2 feutres noires
2 marca-textos pretos
2 pennarelli neri

12 x 12 x 2 u



414095 SURTIDO 4 ROTULADORES

Assortment 4 pastry pens.
Assorti 4 feutres.
Sortido 4 marca-textos.
Assortimento 4 pennarelli

12 x 12 x 4 u



COLORANTES

Colourings · Colorants · Colorantes · Coloranti

EN PASTA

In paste · En pâte · Em pasta · In pasta



Modo de uso
How to use
Comment l'utiliser
Como utilizar
Come si usa



415057

Caja surtida - Assorted box
Boîte assortis - Caixa assortada
Scatola assortimento

120 g · 30 g x 4 u



180 g · 30 g x 6 u

415037					
415046					
415047					
415049					
415052					
415053					
415054					
415055					
415056					



200 g · 1 u

NEW	415028					
	415040					
NEW	415041					
	415042					
	415043					
	415044					
	415045					
	415048					
NEW	415097					

Dosis orientativa: 5 g x 10 Kg / Indicative dosis: 5 g x 10 Kg / Dose suggérée: 5 g x 10 Kg / Dose indicada: 5 g x 10 Kg / Dose consigliata: 5 g x 10 Kg

COLORANTES

Colourings · Colorants · Colorantes · Coloranti

EN POLVO LIPOSOLUBLES

Liposoluble in powder · En poudre liposolubles · Em pó lipossolúveis · In polvere liposolubile

Modo de uso
How to use
Comment l'utiliser
Como utilizar
Come si usa



Colorante en polvo liposoluble ideal para la decoración de chocolate blanco, cremas, nata, pasta de azúcar, pasta para moldear, pasta de almendra, mazapán, manteca, semifríos o cualquier otro producto de base grasa.

Será aconsejable realizar una pre-mezcla del contenido a colorear para facilitar el uso y conseguir un color uniforme.

Liposoluble powder colorant perfect for decorating white chocolate, custard, cream, sugar paste, moulding paste, almond paste, marzipan, butter, parfaits or any other fat-based product. You should prepare a pre-mix of the content that is to be coloured to make it easier to use and attain a uniform colour. Colorant en poudre liposoluble, idéal pour décorer le chocolat blanc, les crèmes, crèmes dessert, la pâte à sucre, les pâtes à mouler, la pâte d'amande, le mûssepain, le beurre, les parfait ou tout autre produit à base de matières grasses. Il est conseillé de faire un pré-mélange du contenu à colorier pour faciliter l'utilisation et obtenir une couleur uniforme. Corante em pó lipossolúvel ideal para a decoração com chocolate branco, cremes, nata, pasta de açúcar, pasta para moldar, pasta de amêndoa, maçaçãõ, manteiga, semifrios ou qualquer outro produto de base gorda. É aconselhável realizar uma pré-mistura do conteúdo a colorir para facilitar a utilização e conseguir uma cor uniforme. Colorante in polvere liposolubile, ideale per le decorazioni su cioccolata bianca, creme, panna, pasta di zucchero, pasta per fare stampi, pasta di mandorle, marzapane, burro, semifreddi o qualsiasi altro prodotto con base grassa Sarà opportuno realizzare una pre-miscela del contenuto da colorare, al fine di facilitarne l'utilizzo e ottenere un colore uniforme.

EFECTO PERLADO / | "Pearl effect" · Effet perlé · Efeito nacarado · Effetto perlati

25 g

Esta gama te permite conseguir efectos perlados y brillantes en masas, azúcar, frostings y chocolate.

This range allows you to obtain shiny pearl effects on dough, sugar, frosting and chocolate.

Cette gamme vous permet d'obtenir des effets nacrés et brillants en pâte, sucre, glaçage et chocolat.

Esta gama permite obter efeitos perlados e brilhantes em massas, açúcar, coberturas glacé e chocolate.

Questa linea consente di ottenere effetti perlati e brillanti, su impasti, zucchero, frosting e cioccolato.



418021 Bronce					
418140 Cobre					
418141 Rubí					
418151 Oro					
418152 Plata					

COLORANTES

Colourings · Colorants · Colorantes · Coloranti

EN POLVO LIPOSOLUBLES

Liposoluble in powder · En poudre liposolubles · Em pó lipossolúveis · In polvere liposolubile

EFFECTO MATE / Matte effect · Effet mat · Efeito mate · Effeto opaco

 25 g

Además, se trata de colorantes versátiles porque permite usarlos tanto para colorear superficialmente de forma directa, aplicándolos con un pincel o mezclándolos con una pequeña parte de alcohol.

 Furthermore, they are versatile colours because they can be used to colour straight onto the surface, applying them with a brush or mixing them with a small amount of alcohol.

 En plus, il s'agit de colorants polyvalents qui peuvent être utilisés aussi bien pour colorer rapidement une surface, en les appliquant au pinceau ou en les mélangeant avec une petite quantité d'alcool.

 Também é corantes versáteis porque pode-se utilizá-los para colorir superficialmente de forma direta, aplicando-os com um pincel ou misturando-os com uma pequena quantidade de álcool.

 Inoltre, si tratta di coloranti versatili perché possono essere utilizzati sia per colorare le superfici direttamente, applicandoli con un pennello o mescolando con una piccola parte di alcol.

418143

Amarillo



418037

Amarillo

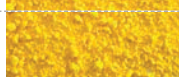

418144 Rojo



418038 Rojo



418175

Rojo Ferrari



418040 Verde



418039

Naranja



418130 Violeta

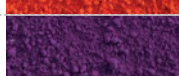

418036 Azul

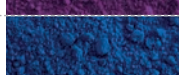

418153 Rosa

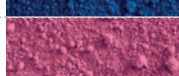

418034 Negro

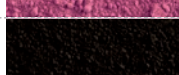

418154 Blanco



COLORANTES

Colourings · Colorants · Colorantes · Coloranti

EN POLVO HIDROSOLUBLES





Water soluble powder · En poudre hydrosoluble dans l'eau · Em pó hidrossolúveis
In polvere idrosolubile

 25 g

Modo de uso
How to use
Comment l'utiliser
Como utilizar
Come si usa



Colorantes en polvo hidrosolubles ideales para colorear todo tipo de masas de productos a base de agua como pasta de azúcar, isomalt nata, merengue, macarons, bebidas y productos de panadería (bollería, galletas, tartas y gofres). Agregar el colorante directamente al producto.

 Water-soluble powder ideal to mass colouring water-base products like sugar paste, isomalt, cream, meringue, macarons, cocktail, confectionery and fine bakery (pastries, cookies, cakes and wafers). Directly add the powder to the product to be colored.  Colorants en poudre solubles dans l'eau, parfaits pour colorer tout type de produits à base d'eau tels que la pâte à sucre, l'isomalt, la crème, la meringue, les macarons, les boissons et les produits de boulangerie (viennoiseries, biscuits, gâteaux et gaufres). Ajouter le colorant directement au produit.  Corantes em pó hidrossolúveis ideais para colorir todo o tipo de massas de produtos à base de água como, por exemplo, pasta de açúcar, isomalt nata, merengue, macarons, bebidas e produtos de padaria (bolos, bolachas, tartes e gofres). Adicionar o corante diretamente ao produto.  Colorante in polvere idrosolubile ideale per la colorazione in massa di prodotti a base acqua quali pasta di zucchero, isomalto zucchero, panna, meringhe, macarons, cocktails, prodotti di confetteria e da forno fini (pasticcini, biscotti, torte e cialde). Aggiungere la polvere direttamente al prodotto da colorare.



418133				
418134				
418135				
418136				
418137				
418138				
418142				







COLORANTES

Colourings · Colorants · Colorantes · Coloranti

PULVERIZADOR

Sprinkler · Pulvérisateur · Spruzzatore

Colorante en polvo con dosificador para obtener efectos perlados y metalizados en elaboraciones de todo tipo, desde cremas, fondants, frostings, masas, chocolate, etc. Pulveriza directamente sobre la superficie del producto a colorear.

 Powder colourant with a dispenser to obtain a pearlescent and metallic effect on all kinds of confectionery products, including creams, fondants, frostings, dough, chocolate, etc. Spray directly onto the surface of the product to be coloured.  Colorant en poudre avec doseur pour obtenir des effets perlés et métallisés dans des préparations de tout type, des crèmes, fondants, glaçages, pâtes, chocolat, etc. Vaporisez directement sur la surface du produit à colorer.  Corante em pó com doseador para obter efeitos perlados e metalizados em elaborações de todo tipo, desde cremas, fondants, coberturas de glacé, massas, chocolate, etc. Pulverize diretamente sobre a superfície do produto a colorir.  Colorante in polvere con dosatore per ottenere effetti perlati e metallizzati, in lavorazioni di qualsiasi tipo, dalle creme, fondant, frosting, impasti, cioccolato, ecc. Spolverare direttamente sulla superficie del prodotto da colorare.

EFECTO PERLADO

“Pearl effect” · Effet perlé · Efeito nacarado · Effetti perlati

 10 g



418155
ORO - Gold
Or - Ouro



418070
ROJO - Red Rouge
Vermelho - Rosso



418174
PLATA - Silver
Argent - Prata
Argento



418159
VERDE ESMERALDA
Esmeralda green
Vert émeraude



418160
VIOLETA
Violet - Violette
Viola



418157
NEGRO - Black
Noir - Preto - Nero



418158
LILA - Lilac
Lila - Lilás



418156
ROSA - Pink
Rose - Rosa



COLORANTES

Colourings · Colorants · Colorantes · Coloranti

SPRAYS - BASE ALCOHOL

Alcohol based · Base d'alcool · Base de álcool · Base alcol

Colorantes alimentarios en spray, son ideales para colorear de forma sencilla productos tanto de azúcar como de chocolate. Para colorear bombones puede rociar directamente el interior del molde antes de rellenarlo con chocolate.

MODO DE USO: Agite bien el bote antes de usar y periódicamente durante la aplicación.

Antes de rociar sobre el postre, practique con una toalla de papel para familiarizarse con la aplicación del rociador.

Rociar a una distancia de 25-30cm sosteniendo el bote lo más vertical posible.

Limpiar la válvula con agua caliente con regularidad.

Deje secar de 1 a 3 minutos.

El rendimiento real variará dependiendo de la intensidad del color deseada.

 Food spray dyes ideal for easily colouring both sugar and chocolate products.

To colour chocolates you can directly spray the inside of the mould before filling it with chocolate.

HOW TO USE: Shake the bottle well before use and periodically during application. Before drizzling over dessert, practice on a paper towel to become familiar with applying the spray. Spray from a distance of 25-30cm, holding the can as vertical as possible. Clean the valve with hot water regularly. Let dry 1 to 3 minutes. Actual performance will vary depending on desired color intensity.

 Resto de idiomas, consultar la web / Consulter les langues sur le site web / Consultar idiomas na web / Per le lingue disponibili consultare il sito web.

EFECTO AERÓGRAFO | Airbrush effect · Effet aérographe · Efeito aerógrafo · Effeto aerografo

 100 ml



430009



430074



430081



430007



430082



430010



430006



430084



430086



COLORANTES

Colourings · Colorants · Colorantes · Coloranti



SPRAYS - BASE ALCOHOL

Alcohol based · Base d'alcool · Base de álcool · Base alcol

Modo de uso
How to use
Comment l'utiliser
Como utilizar
Come si usa

EFFECTO PERLADO

“Pearl effect” · Effet perlé · Efeito nacarado · Effetto perlati

Agrega un acabado perlado a tus creaciones

Add a pearl finish to your creations. Ajoutez une finition perlée à vos créations. Adicione um acabamento perolado às suas criações. Aggiungi una finitura perlata alle tue creazioni



100 ml

430023



NEW

430104



430101



430089

250 ml

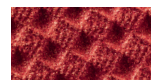

250 ml

430060

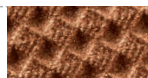

430102



430103







COLORANTES

Colourings · Colorants · Colorantes · Coloranti

SPRAYS - BASE MANTECA DE CACAO

Cocoa butter base · Base beurre de cacao · Base manteiga de cacau · Base burro di cacao

Colorantes alimentarios a base de manteca de cacao coloreada especialmente diseñados para colorear semifríos, helados, mousses, etc.

 Food colourings based on coloured cocoa butter specially designed to colour semifreddos, ice creams, mousses, etc.  Colorants alimentaires à base de beurre de cacao coloré spécialement conçus pour colorer les plats semi-froids, les glaces, les mousses, etc.  Corantes alimentares à base de manteiga de cacau colorida especialmente concebidos para colorir semifrios, gelados, mousses, etc.  Coloranti alimentari a base di burro di cacao colorato, pensati specificamente per la colorazione di semifreddi, gelati, mousse ecc.





Modo de uso
How to use
Comment l'utiliser
Como utilizar
Come si usa

Aplicados sobre una superficie **congelada**, la manteca de cacao se cristaliza creando el efecto terciopelo.

MODO DE USO: El contenido del spray debe estar a una temperatura de entre 20 y 25 grados para que la manteca de cacao no esté solidificada. Si fuera necesario puede ser calentado al baño maría. Agitar enérgicamente para que los ingredientes se mezclen perfectamente. Rociar la pieza con el bote en posición vertical a una distancia de 20cm. Limpiar la boquilla con agua caliente tras su uso para evitar que queden restos y se obstruya.

 Applied to a **frozen** surface, cocoa butter crystallizes, creating the velvet effect. **DIRECTIONS FOR USE:** The content of the spray must be at a temperature between 20 and 25 degrees so that the cocoa butter is not solidified. If necessary it can be heated in a water bath. Shake vigorously so that the ingredients mix perfectly. Spray the piece with the can in a vertical position from a distance of 20cm. Clean the nozzle with hot water after use to prevent debris and clogging.

 Appliqué sur une surface **gelée**, le beurre de cacao cristallise, créant un effet velours. **CONSEILS D'UTILISATION:** Le contenu du spray doit être à une température comprise entre 20 et 25 degrés pour que le beurre de cacao ne se solidifie pas. Si nécessaire, il peut être chauffé au bain-marie. Agiter vigoureusement pour que les ingrédients se mélangent parfaitement. Vaporisez la pièce avec le bidon en position verticale à une distance de 20 cm. Nettoyez la buse avec de l'eau chaude après utilisation pour éviter les débris et le colmatage.

 Aplicada sobre uma superfície **congelada**, a manteiga de cacau cristaliza, criando o efeito aveludado. **INSTRUÇÕES DE USO:** O conteúdo do spray deve estar a uma temperatura entre 20 e 25 graus para que a manteiga de cacau não solidifique. Se necessário, pode ser aquecido em banho-maria. Agite vigorosamente para que os ingredientes se misturem perfeitamente. Pulverize a peça com a lata na posição vertical a uma distância de 20cm. Limpe o bico com água quente após o uso para evitar detritos e entupimentos.

 Applicato su una superficie **ghiacciata**, il burro di cacao cristallizza creando l'effetto velluto. **CONSIGLI D'USO:** Il contenuto dello spray deve essere ad una temperatura compresa tra 20 e 25 gradi in modo che il burro di cacao non si solidifichi. Se necessario può essere riscaldato a bagnomaria. Agitare vigorosamente in modo che gli ingredienti si amalgamino perfettamente. Spruzzare il pezzo con la bomboletta in posizione verticale da una distanza di 20cm. Pulire l'ugello con acqua calda dopo l'uso per evitare detriti e intasamenti.

EFECTO TERCIPELO

Velvet effect · Effet velours · Efeito veludo · Effetto velluto



100 ml

NEW

430096

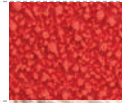

430098



400 ml

430076

Rojo cerezo

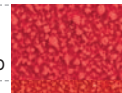

430091

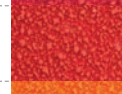

430029



430092



430093



430095



430035



430099

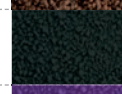

430100



COLORANTES

Colourings · Colorants · Colorantes · Coloranti







SUPER COLORS



























COLORANTE SUPER CONCENTRADO

Super concentrated liquid liposoluble dye
Colorant super concentré liquide liposoluble
Corante líquido super concentrado lipossolúvel
Colorante super concentrato liquido liposolubile

30 ml · 1 u.

Colorante super concentrado líquido liposoluble. No modifica ni el sabor ni la consistencia del producto a colorear. Puedes modular la intensidad del color en función de la cantidad de colorante fácilmente gracias a su tapón dosificador. Indicado para colorear masas con base grasa como chocolate, buttercream, masas para hornear, manteca de cacao, natas, etc. Sin E171, sin gluten, sin alcohol. Apto para veganos y Kosher.

 Super concentrated liquid liposoluble dye. It does not alter the taste or consistency of the product being colored. You can easily adjust the color intensity based on the amount of dye thanks to its dosing cap. Suitable for coloring fat-based masses such as chocolate, buttercream, baking doughs, cocoa butter, creams, etc. No E171, gluten-free, alcohol-free. Suitable for vegans and Kosher. /  Colorant super concentré liquide liposoluble. Il ne modifie ni le goût ni la consistance du produit à colorer. Vous pouvez facilement ajuster l'intensité de la couleur en fonction de la quantité de colorant grâce à son bouchon doseur. Convient pour colorer les pâtes à base de matières grasses telles que le chocolat, le beurre, les pâtes à pâtisserie, le beurre de cacao, les crèmes, etc. Sans E171, sans gluten, sans alcool. Adapté aux végétaliens et casher. /  Corante líquido super concentrado lipossolúvel. Não altera o sabor nem a consistência do produto a ser colorido. Você pode ajustar facilmente a intensidade da cor com base na quantidade de corante graças à sua tampa dosadora. Indicado para colorir massas à base de gordura, como chocolate, buttercream, massas para assar, manteiga de cacau, natas, etc. Sem E171, sem glúten, sem álcool. Adequado para veganos e kosher. /  Colorante super concentrato liquido liposolubile. Non modifica né il sapore né la consistenza del prodotto da colorare. Puoi facilmente regolare l'intensità del colore in base alla quantità di colorante grazie al suo tappo dosatore. Indicato per colorare impasti a base di grassi come cioccolato, crema di burro, impasti per la cottura, burro di cacao, panna, ecc. Senza E171, senza glutine, senza alcool. Adatto per vegani e kosher.

	412067					
	412068					
	412069					
	412070					
	412071					
	412072					



YouTube



COLORANTES

Colourings · Colorants · Colorantes · Coloranti



COLORANTES

Colourings · Colorants · Colorantes · Coloranti



LÍQUIDOS LIPOSOLUBLES

Liposoluble liquids · Liquides liposolubles
Líquidos lipossolúveis · Liquidi liposolubili

Modo de uso
How to use
Comment l'utiliser
Como utilizar
Come si usa

Colorantes liposolubles con base de aceite y textura oleosa ideal para la decoración de chocolate, coberturas y otras masas grasas como cremas y manteca.

Se recomienda agitar previamente para homogeneizar el producto y con la ayuda de su nuevo tapón dosificador podrá agregar progresivamente el colorante hasta conseguir la intensidad de color deseada.

 Liposoluble dye with oil base and oily texture ideal for decorating chocolate, coatings and other high in fat doughs such as creams and butters. It is recommended that you stir the product beforehand to blend it and with the helpfull new dosing cap you can add the dye gradually until you reach the desired color intensity.

 Colorant liposoluble à base d'huile et à texture huileuse, idéal pour décorer le chocolat, les enrobages et autres compositions grasses comme les crèmes et le beurre. Il est conseillé d'agiter le colorant au préalable pour homogénéiser le produit. Aidez-vous ensuite du nouveau bouchon doseur pour ajouter progressivement le colorant jusqu'à l'obtention de l'intensité de couleur souhaitée.

 Corante lipossolúvel com base de óleo e textura oleosa ideal para a decoração com chocolate, coberturas e outras massas gordas como cremes e manteiga. Recomenda-se agitar previamente para homogeneizar o produto e ajudar-lhe com a sua nova tampa doseadora para adicionar progressivamente o corante até conseguir a intensidade de cor desejada.

 Coloranti liposolubili a base di olio con consistenza oleosa, ideali per la decorazione del cioccolato, coperture e altri elementi grassi, come creme e burro. Si consiglia di agitare per omogeneizzare il prodotto. Servendosi del nuovo tappo con dosatore, è possibile aggiungere progressivamente il colorante fino a raggiungere l'intensità desiderata del colore.

EFECTO NEUTRO | Neutral effect · Effet neutre · Efeito neutro · Effeto neutro

 100 g



412024



412025



412026



412027



412066



COLORANTES

Colourings · Colorants · Colorantes · Coloranti



KIT AERÓGRAFO

Airbrush Kit · Kit aérographe

539000

AERÓGRAFO

Airbrush - Aérographe - Aerógrafo

 1 u



El Kit incluye: aerógrafo doble acción de 0,2 mm, mini compresor de 1 bar, soporte para aerógrafo y bolsa de viaje.

 The Kit includes: dual action 0.2 mm airbrush, 1 bar mini compressor, airbrush holder and travel bag.

 Le kit comprend : un aérographe à double action de 0,2 mm, un mini compresseur de 1 bar, un support pour aérographe et un sac de voyage.

 O kit inclui: aerógrafo de dupla ação de 0,2 mm, mini compressor de 1 barra, suporte para aerógrafo e bolsa de viagem.

 Il kit comprende: aerografo a doppia azione da 0,2 mm, mini compressore da 1 bar, supporto per l'aerografo e contenitore da viaggio.



Ref. 412035

LIMPIADOR DE AERÓGRAFO

Airbrush cleaner

Ettoyant aérographie

Limpador para aerógrafo

Detersivo per aerografo

100 ml



COLORANTES

Colourings · Colorants · Colorantes · Coloranti

LÍQUIDOS ESPECIALES PARA AERÓGRAFO BASE AGUA

For airbrush water based · Pour aérographe base d'eau

Para aerógrafo base de água · Liquido speciale per aerografo base d'acqua

Colorante líquido indicado para difuminar, marcar y pintar superficies de tartas y dulces con la ayuda de un aerógrafo. Gracias a su formulación hidrosoluble, también es ideal para la coloración de nata, cremas, gelatinas, pasta de almendra, mazapán, azúcar y bebidas en general.

 Liquid dye indicated to blend, set and paint cake and candy surfaces with the help of an airbrush. Thanks to its water-soluble composition, it is also ideal for coloring whipped cream, creams, jellies, almond paste, marzipan, sugar and drinks in general.



 Colorant liquide parfait pour recouvrir, marquer et peindre les surfaces de gâteaux et autres desserts à l'aide d'un aérographe. Grâce à sa formulation hydrosoluble, ce colorant est également idéal pour la coloration des crèmes dessert, crèmes, gélatines, de la pâte d'amande, du massepain, du sucre et des boissons en général.

 Corante líquido indicado para esfumar, marcar e pintar superficies de bolos y doces com a ajuda de um aerógrafo. Graças à sua fórmula hidrossolúvel, também é ideal para a coloração de natas, cremes, gelatinas, pasta de amêndoa, maçapão, açúcar e bebidas em geral.

 Colorante liquido indicato per sfumare, evidenziare e dipingere superfici di torte e dolci con l'aerografo. Grazie alla sua formulazione idrosolubile, è anche ideale per la colorazione di panna, creme, gelatine, pasta di mandorle, marzapane, zucchero e bevande in generale.

EFECTO PERLADO |
“Pearl effect” · Effet perlé
Efeito nacarado · Effetto
perlati



 190 ml ·  1 u

412031



EFECTO NEUTRO | Neutral effect · Effet neutre
Efeito neutro · Effeto neutro



 190 ml ·  1 u 

412012



412017



412014



412018



412015



412019



412016



412020



412021



COLORANTES

Colourings · Colorants · Colorantes · Coloranti

CONSUMIBLES PARA IMPRESORAS

Consumables for printers · Consommables pour des imprimantes
Consumíveis para impressoras · Idonei all'uso con stampante

PASO A PASO

Step by step - Pas à pas - Passo a passo - Passo dopo passo

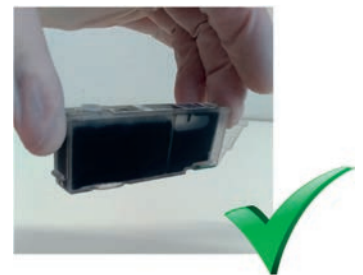

1 - Retirar las protecciones color naranja del cartucho.



Take the orange protectors off the cartridge.



Retirer les protections couleur orange de la cartouche.



Retirar as proteções côr de laranja dos tinteiros.



Rimuovere le protezioni arancioni dalla cartuccia

2 - Sujetar el cartucho por los extremos sin apretar el tanque de tinta, de lo contrario la tinta saldrá por el orificio.



Hold the cartridges at each end without squeezing the ink can, if not then the ink will leak out of the hole.



Fixer la cartouche par les extrémités sans serrer la réserveoir d'encre, sinon l'encre sortira par l'orifice.



Segurar o tinteiro nos extremos sem apertar o tanque da tinta, caso contrario a tinta sai pelo orificio.



Afferrare la cartuccia dalle estremità senza esercitare pressioni sul serbatoio dell'inchiostro o questo uscirà dall'orifizio

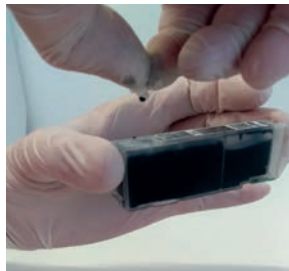

3 - Retirar la tapa de silicona.



Take off the silicon lid.



Retirer le couvercle en silicone.



Retirar a tampa de silicone.



Rimuovere il tappo in silicone.



4 - Colocar el cartucho en la impresora.



Place the cartridge in the printer.



Placer la cartouche dans l'imprimante.



Colocar o tinteiro na impressora.



Collocare la cartuccia nella stampante.



5 - Al colocar el cartucho en la impresora, se debe encender un led de color rojo, si no se enciende es que hay algún error. POSIBLES CAUSAS: Chip quemado, cartucho intercambiado, contactos de chip obstruidos, etc.



When the cartridge is placed in the printer, a red LED should light up. If this is not the case, then there is an error. POSSIBLE CAUSES: Burnt chip, switched cartridge, chip contact obstructed, etc.



En plaçant la cartouche dans l'imprimante, il faut allumer une led de couleur rouge. Si elle ne s'allume pas, cela signifie qu'il y a une erreur. CAUSES POSSIBLES : puce brûlée, cartouche échangée, contacts de puce obstrués, etc.



Ao colocar o tinteiro na impressora, tem de acender um led de côr vermelha, caso não acenda, ou caso fique a piscar algo de errado aconteceu! POSSIVEIS CAUSAS: Chip queimado, tinteiro trocado, contactos de chip obstruídos, etc.



Dopo aver collocato la cartuccia nella stampante, si noterà che si accenderà una luce led rossa; se non avviene, allora si è verificato un errore. CAUSE POSSIBILI: chip bruciato, cartuccia invertita, contatti del chip ostruiti, ecc.

COLORANTES

Colourings · Colorants · Colorantes · Coloranti

412023					
412011					
412010					
412000					



Compatible con las impresoras -
Compatible with printers -
Compatible avec les imprimantes -
Compatível com as impressoras -
Compatibile con le stampanti:
EcoTank ET-14000; EcoTank ET-
2500; EcoTank ET-2550;
EcoTank ET-2600; EcoTank ET-2650;
EcoTank ET-4500; EcoTank L355;
EcoTank L555

 1 u.

BOTE COLORANTE PARA IMPRESORAS EPSON (80 c.c.)

Colour box for Epson printers (80 c.c.) - Boîte colorant pour imprimante Epson (80 c.c.)

Pote colorante para impressora Epson (80 c.c.) - Barattolo colorante per stampanti Epson (80 c.c.)

627051					
627052					
627053					
627054					



Compatible con las impresoras -
Compatible with printers -
Compatible avec les imprimantes -
Compatível com as impressoras -
Compatibile con le stampanti:
EcoTank ET4750/3750/3700/
2756/2751/2700/15000/4700/
2726/2720/2715/2714/2712/
2711/2710.

 1 u.

BOTE COLORANTE PARA IMPRESORAS EPSON (100 c.c.)

Colour box for Epson printers (100 c.c.) - Boîte colorant pour imprimante Epson (100 c.c.)

Pote colorante para impressora Epson (100 c.c.) - Barattolo colorante per stampanti Epson (100 c.c.)

627027					
627028					
627026					
627025					



 1 u.

BOTE COLORANTE PARA IMPRESORAS CANON (60 c.c.)

Colour box for Canon printers (60 c.c.) - Boîte colorant pour imprimante Canon (60 c.c.)

Pote colorante para impressora Canon (60 c.c.) - Barattolo colorante per stampanti Canon (60 c.c.)

COLORANTES

Colourings · Colorants · Colorantes · Coloranti

627010						
627007						
627041						
627018						
627006 *						
627042						



CARTUCHOS APTOS PARA LAS NUEVAS IMPRESORAS CANON CON MICROCHIP (PGI-550/CLI-551)

1 u.

Edible ink cartridges for the new Canon printers with microchip.

Des cartouches aptes pour les nouvelles imprimantes Canon avec microchip.

Cartuchos aptos para as novas impressoras Canon com microchip.

Cartucce idonee all'utilizzo con le nuove stampanti canon con microchip.

413003						
413004						
413001						
413002						
413000 *						



CARTUCHOS APTOS PARA LAS NUEVAS IMPRESORAS CANON CON MICROCHIP (PGI-570/CLI-571)

1 u.

Edible ink cartridges for the new Canon printers with microchip.

Des cartouches aptes pour les nouvelles imprimantes Canon avec microchip.

Cartuchos aptos para as novas impressoras Canon com microchip.

Cartucce idonee all'utilizzo con le nuove stampanti canon con microchip.

(*) MAS GRANDE/ bigger/ plus gros/ Maior / Più grandi

COLORANTES

Colourings · Colorants · Colorantes · Coloranti



627047								1 u.
627048							1 u.	
627049							1 u.	
627050							1 u.	
627046 *							1 u.	

Más grande () MAS GRANDE/ bigger/ plus gros/ Maior / Più grandi



CARTUCHOS APTOS PARA LAS NUEVAS IMPRESORAS CANON CON MICROCHIP (PGI580 e CLI581)

(Canon pixma tr7550, Canon pixma tr8550, Canon pixma ts705, Canon pixma ts6150, Canon pixma ts6151, Canon pixma ts6250, Canon pixma ts6251, Canon pixma ts6350, Canon pixma ts8150, Canon pixma ts8151, Canon pixma ts8152, Canon pixma ts9150, Canon pixma ts9155)

Edible ink cartridges for the new Canon printers with microchip.

Des cartouches aptes pour les nouvelles imprimantes Canon avec microchip.

Cartuchos aptos para as novas impressoras Canon com microchip.

Cartucce idonee all'utilizzo con le nuove stampanti canon con microchip.



413006							1 u.
413007							1 u.
413008							1 u.
413009							1 u.

CARTUCHOS APTOS PARA IMPRESORAS EPSON 16 Series

(WF-2540WF, WF-2520NF, WF-2510WF, WF-2010W)

Edible ink cartridges for Epson printers with microchip - Des cartouches aptes pour imprimantes Epson

Cartuchos aptos para as impressoras Epson - Cartucce adatte per stampanti Epson.

TUTORIAL CARTUCHOS TINTA ALIMENTARIA

Food dye containers - Cartouches d'encre alimentaire - Cartuchos de tinta comestível - Tutorial cartucce inchiostro alimentare

Escanea este código QR y sigue los sencillos pasos de este video.

Scan this QR code and follow the simple steps in this video.

Scannez ce code QR et suivez les étapes de cette vidéo.

Digitalize este código QR e siga os passos simples deste vídeo.

Scannerizza questo codice QR e segui le semplici istruzioni fornite nel video.



COLORANTES

Colourings · Colorants · Colorantes · Coloranti

LÁMINA COMESTIBLE PARA IMPRIMIR SIN AZÚCAR

Free sugar edible printer sheets · Feuilles comestibles pour impression sans sucre · Folhas comestíveis para imprimir sem açúcar · Lamina commestibile per la stampa senza zucchero

SIN AZÚCAR Gracias a su composición es apto para clientes que buscan reducir o controlar el consumo de azúcar.

FABRICADO EN EUROPA

Elaborado bajo estrictos controles de calidad.



421005		ZERO A3 - 29,7 x 42 cm	20 u.	
421004	LÁMINA COMESTIBLE Edible printer sheets Feuilles comestibles pour impression Folhas comestíveis para imprimir Lamina commestibile	ZERO A4 - 21 x 29,7 cm	25 u.	
421010		A4 - 21 x 29,7 cm	25 u.	

SUGAR FREE Thanks to its composition, it is suitable for customers looking to reduce or control their sugar intake. **MADE IN EUROPE** Produced under strict quality controls.

SANS SUCRE Grâce à sa composition, il convient aux clients qui cherchent à réduire ou à contrôler leur consommation de sucre. **FABRIQUÉ EN EUROPE.** Fabriqué sous de stricts contrôles de qualité.

SEM AÇÚCAR Devido à sua composição é apropriado para clientes que pretendem reduzir ou controlar o consumo de açúcar. **FABRICADO NA EUROPA** Preparado sob rigorosos controles de qualidade.

SENZA ZUCCHERO Grazie alla sua speciale composizione, risulta idoneo per clienti che mirano a ridurre o controllare il consumo di zuccheri. **PRODOTTO IN EUROPA** Prodotto osservando i più rigorosi standard di qualità.



OBLEA PARA IMPRIMIR

Wafer ready to print · Azyme pour imprimer · Obreia para imprimir · Oblea per la stampa

★ 107127

DOBLE CARA LISA

Double smooth face

Double face lisse.

29,7 x 42 cm **DIN A3** · 50 u



107117

DOBLE CARA LISA

Double smooth face

Double face lisse.

21 x 29,7 cm **DIN A4** · 50 u

650 g aprox. · 0,65 mm aprox.



107031

UNA CARA LISA PARA MÁQUINAS DE ÚLTIMA GENERACIÓN.

One smooth face for new generation printers. Une face lisse.

Un lato liscio per le macchine di ultima generazione

21 x 29,7 cm **DIN A4** · 50 u

270 g aprox. · 0,27 mm aprox.



COLORANTES

Colourings · Colorants · Colorantes · Coloranti

OBLEA INDUSTRIAL

Industrial wafer · Azyme industrielle Obreia industrial · Oblea industriale



107033

Ø 20 cm

150 u.



107020

50 x 40 cm · 2 kg.



107022

70 x 40 cm · 3 kg.



OBLEA INDUSTRIAL: 1 CARA LISA/ 1 CARA RAYADA

Industrial wafer: 1 Face lined/ 1 face smooth. • Azyme industrielle: 1 Face lisse/1 face rayée.

Obreia industrial: 1 Cara lisa/ 1 cara rayada. • Oblea industriale: 1 lato liscio / 1 faccia rigata.

LÁMINA SERIGRAFÍA PARA IMPRESIÓN EN CHOCOLATE

Transfer sheet for chocolate printing
Lame serigraphie impression en chocolat

Lâmina serigrafia para impressão em chocolate

Lamina da serigrafia per la stampa sul cioccolato

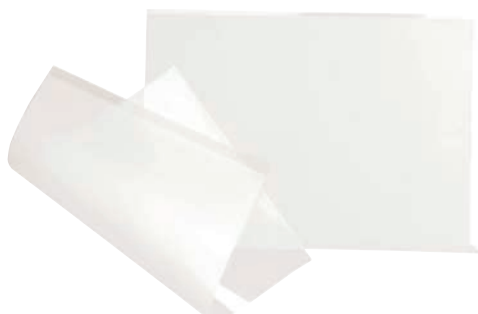

545083

21 x 29,7 cm **DIN A4**

30 u.



LÁMINA COMESTIBLE TROQUELADA

Edible die-cut sheet

Lame comestible découpe

Lámina cortada comestível

Lamina commestibile fustellata



421008

Ø 20 cm

25 u.



421009

Ø 5 cm

25 u.



COLORANTES

Colourings · Colorants · Colorantes · Coloranti



Resto de idiomas
Other languages
Autres langues
Outros idiomas
Altre lingue



CARTUCHOS Y BOTES DE TINTA ALIMENTARIA CONSEJOS Y RECOMENDACIONES

Food ink cartridges and containers. Tips and recommendations
Cartouches et récipients d'encre alimentaire. Conseils et recommandations
Cartuchos e recipientes de tinta alimentícia. Dicas e recomendações
Cartucce e contenitori di inchiostro alimentare. Consigli e raccomandazioni



En el mercado hay de dos tipos de impresoras, **EPSON** y **CANON**:

EPSON

Trabajan mediante un sistema de impresión que impulsa la gota de tinta desde la boquilla al papel a través de una presión.

Work by a printing system that propels ink droplets from the nozzle to the paper through pressure.

Canon

Tienen un proceso de inyección térmico.

A pesar de su buena calidad de impresión, las tintas CANON pueden sufrir cambios debido a ese calentamiento que necesitan para su funcionamiento. Por otro lado, las tintas EPSON por lo general garantizan una mayor rapidez y estabilidad con las tintas y tienen una buena calidad de impresión.



Nuestra recomendación es usar impresoras **EPSON** con nuestros cartuchos y/o botes de tinta alimentaria compatibles.

IMPRESORAS Y TINTAS COMPATIBLES

Compatible printers and inks - Imprimantes et encres compatibles - Impressoras e tintas compatíveis
Stampanti e inchiostri compatibili



En estas páginas podrá buscar y comprobar qué impresoras o qué cartuchos y tintas son compatibles:



On these pages, you can search and check which printers or which cartridges and inks are compatible:



Sur ces pages, vous pouvez rechercher et vérifier quelles imprimantes ou quelles cartouches et encres sont compatibles. compatibles:



Nestas páginas, você pode procurar e verificar quais impressoras ou quais cartuchos e tintas são compatíveis:



Su queste pagine, è possibile cercare e verificare quali stampanti o quali cartucce e inchiostri sono compatibili:

Canon



EPSON



deKora



DECORACIÓN NO COMESTIBLE

Non edible decoration · Décoration non comestible
Decoração não comestível · Decorazione non commestibile

DECORACIÓN NO COMESTIBLE

Non edible decoration · Décoration non comestible · Decoração não comestível
Decorazione non commestibile

PVC · PLASTIC FIGURINES



NEW **303024**
KIT PVC MINNIE
CON VELAS
9 cm · x 6



NEW **303028**
KIT PVC TESIA
CON VELAS
8,5 cm · x 6



NEW **303025**
KIT PVC FROZEN
CON VELAS
9,5 cm · x 6



DECORACIÓN NO COMESTIBLE

Non edible decoration · Décoration non comestible · Decoração não comestível
Decorazione non commestibile

PVC · PLASTIC FIGURINES



(x 10 u.)



(x 10 u.)



303023
KIT PVC MICKEY
CON VELAS

9 cm ·  x 6 



(x 10 u.)



(x 10 u.)



303027
KIT PVC PAW PATROL
CON VELAS

6 cm ·  x 6 



DECORACIÓN NO COMESTIBLE

Non edible decoration · Décoration non comestible · Decoração não comestível
Decorazione non commestibile

PVC · PLASTIC FIGURINES



NEW **303026**
KIT PVC SPIDERMAN
CON VELAS
9 cm · x 6



NEW **303029**
KIT PVC FÚTBOL
CON VELAS
8,5 cm · x 6



302057
BALONES FÚTBOL
Ø 2,3 cm · x 12 x 6 u.



DECORACIÓN NO COMESTIBLE

Non edible decoration · Décoration non comestible · Decoração não comestível
Decorazione non commestibile

PVC · PLASTIC FIGURINES



350092
CAPITÁN AMÉRICA

7,5 cm · x 6



350143
SPIDER-MAN

9 cm · x 6



NEW **302018**
KIT PVC FÚTBOL

8,5 cm · x 6



DECORACIÓN NO COMESTIBLE

Non edible decoration · Décoration non comestible · Decoração não comestível
Decorazione non commestibile

PVC · PLASTIC FIGURINES



350144
FROZEN

9,5 cm · x 6



350091
CENICIENTA & BELLA

9,5 cm · x 6



303018
UNICORNIO / UNICORN

8,5 cm · x 6



DECORACIÓN NO COMESTIBLE

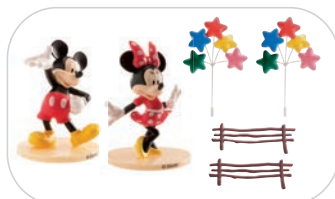

Non edible decoration · Décoration non comestible · Decoração não comestível
Decorazione non commestibile

PVC · PLASTIC FIGURINES



350057
MICKEY & MINNIE
9 cm ·  x 6 



350233
WINNIE THE POOH
8,5 cm ·  x 6 



350249
11 cm ·  x 6 kits



DECORACIÓN NO COMESTIBLE

Non edible decoration · Décoration non comestible · Decoração não comestível
Decorazione non commestibile

PVC · PLASTIC FIGURINES





302012
MINNIE
8,5 cm ·  x 6 



302029
PEPPA PIG
11 cm ·  x 4 



302044
PAW PATROL
6 cm ·  x 6 

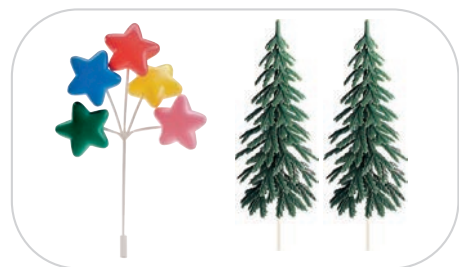

DECORACIÓN NO COMESTIBLE

Non edible decoration · Décoration non comestible · Decoração não comestível
Decorazione non commestibile

PVC · PLASTIC FIGURINES

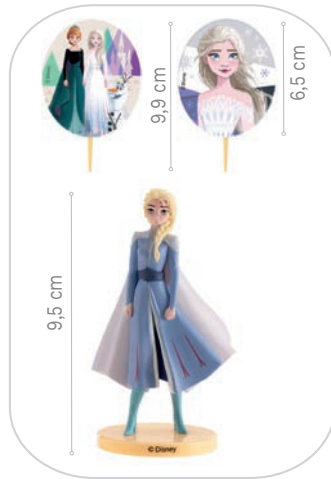
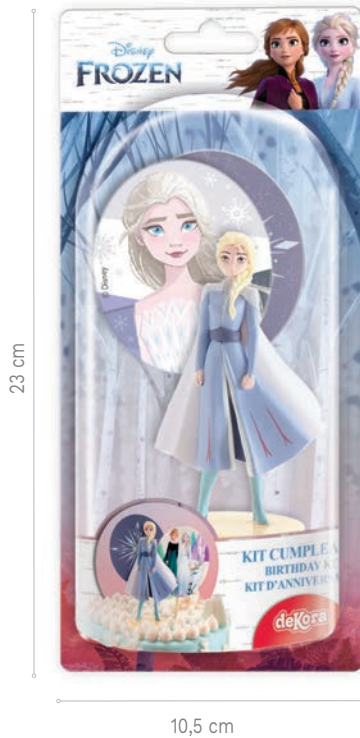

303020
FROZEN
9,5 cm · x 6



Front - Anverso



Back - Reverso



303005
IRON MAN
7,5 cm · x 6

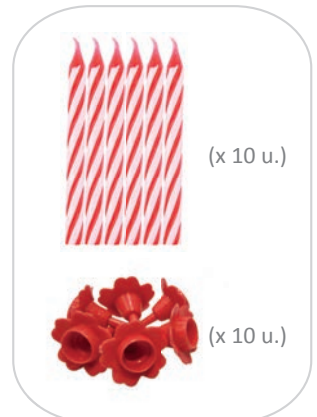

DECORACIÓN NO COMESTIBLE

Non edible decoration · Décoration non comestible · Decoração não comestível
Decorazione non commestibile

PVC · PLASTIC FIGURINES

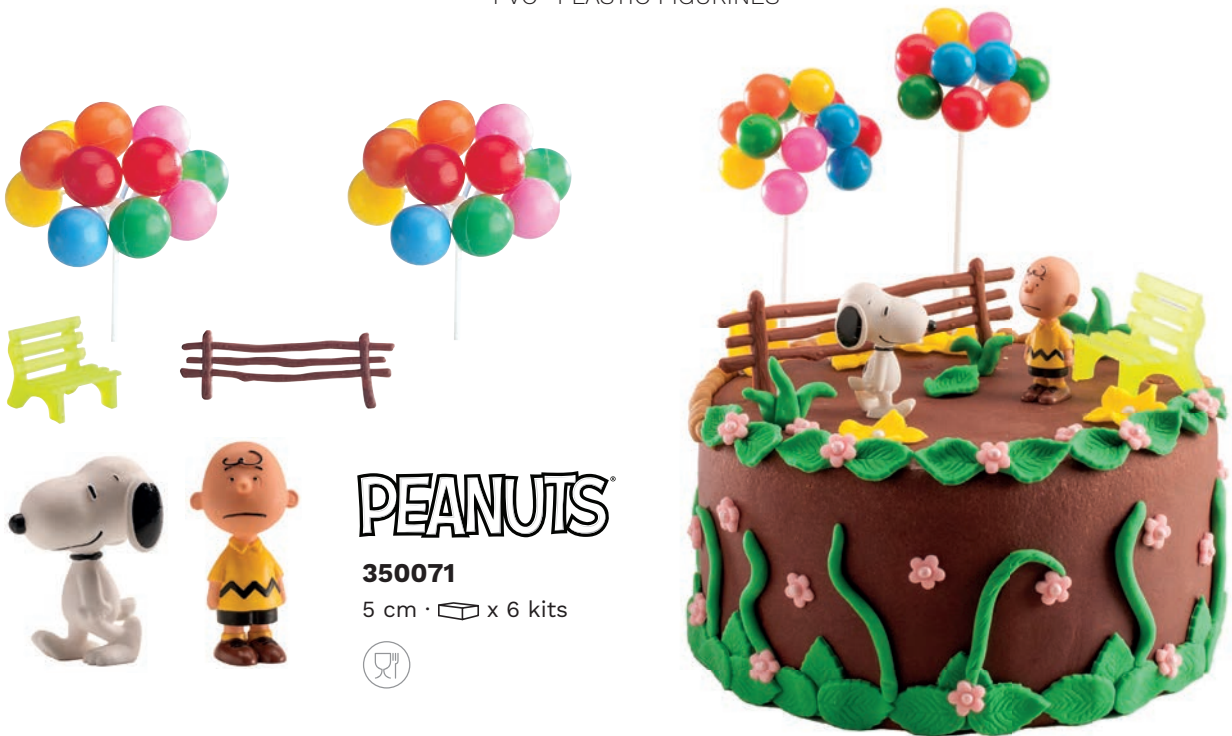

DECORACIÓN NO COMESTIBLE

Non edible decoration · Décoration non comestible · Decoração não comestível
Decorazione non commestibile

PVC · PLASTIC FIGURINES



2 u.

350186

5 - 6,5 cm ·  x 12 kits



350196

6 cm ·  x 6 kits₁₁ x H: 12 cm

2 u.



DECORACIÓN NO COMESTIBLE

Non edible decoration · Décoration non comestible · Decoração não comestível
Decorazione non commestibile

PVC · PLASTIC FIGURINES

Disney
JUNIOR
MICKEY



350181
MICKEY AND FRIENDS

3 - 3,5 cm · 6 u.



DECORACIÓN NO COMESTIBLE

Non edible decoration · Décoration non comestible · Decoração não comestível
Decorazione non commestibile

PVC · PLASTIC FIGURINES



347173
MICKEY

9 cm ·  6 u.



347174
MINNIE

9 cm ·  6 u.



347150
PLUTO

7 cm ·  6 u.



347148
DONALD

8,5 cm ·  x 6 u.



Disney



347149
DAISY

8,5 cm ·  6 u.



347157
CARS

8 cm
 6 u.



Disney
Winnie
the Pooh



347182
WINNIE THE
POOH

8,5 cm ·  6 u.



DECORACIÓN NO COMESTIBLE

Non edible decoration · Décoration non comestible · Decoração não comestível
Decorazione non commestibile

PVC · PLASTIC FIGURINES



347168
UNICORNIO
UNICORN
8,5 cm · 6 u.



347131
PAW PATROL
6 cm · 12 u.



347121
PEPPA PIG
11 cm · 6 u.



347052
DORA EXPLORADORA
7,5 cm · 12 u.



347159
SHIMMER
8 cm · 6 u.



347160
SHINE
8 cm · 6 u.



347145
BRANCH - TROLLS
7 cm · 6 u.



347094
BOB ESPONJA
8 cm · 12 u.



DECORACIÓN NO COMESTIBLE

Non edible decoration · Décoration non comestible · Decoração não comestível
Decorazione non commestibile

PVC · PLASTIC FIGURINES



347170

ELSA

9,5 cm ·  6 u.



347171

ANNA

9,5 cm ·  6 u.



347172

OLAF

5,5 cm ·  6 u.



347155

ARIEL

8,5 cm ·  6 u.



347107

BELLA

8,5 cm ·  6 u.



347108

CENICIENTA

8,5 cm ·  6 u.



DECORACIÓN NO COMESTIBLE

Non edible decoration · Décoration non comestible · Decoração não comestível
Decorazione non commestibile

PVC · PLASTIC FIGURINES



347169
HULK
9 cm · 6 u.



347152
CAPITÁN AMÉRICA
7,5 cm · 6 u.



347153
IRON MAN
7,5 cm · 6 u.



347120
TORTUGAS NINJA
8 cm · 12 u.



347158
SPIDER-MAN
9 cm · 6 u.



DECORACIÓN NO COMESTIBLE

Non edible decoration · Décoration non comestible · Decoração não comestível
Decorazione non commestibile

PVC · PLASTIC FIGURINES



PEANUTS

347133
PEANUTS
5 cm · x 5 u



PEANUTS

347134
PEANUTS
5 cm · x 5 u



PEANUTS

347135
PEANUTS
5 cm · x 5 u



los
PITUFOS

347123
LOS PITUFOS
5,5 cm · 12 u.



DECORACIÓN NO COMESTIBLE

Non edible decoration · Décoration non comestible · Decoração não comestível
Decorazione non commestibile



347141
JETT

9 cm · 6 u.



347142
JEROME

9 cm · 6 u.



347143
DIZZY

9 cm · 6 u.



MINIONS

349006
STUART_MINIONS

6 cm · 10 u.

Porcelana · Porcelain
Porcelaine · Porcellana



MINIONS

349000
KEVIN_MINIONS

7 cm · 10 u.

Porcelana · Porcelain
Porcelaine · Porcellana



Trolls

349009
BRANCH_TROLLS

7 cm · 10 u.

Porcelana · Porcelain
Porcelaine · Porcellana



Trolls

349030
POPPY_TROLLS

7 cm · 10 u.

Porcelana · Porcelain
Porcelaine · Porcellana

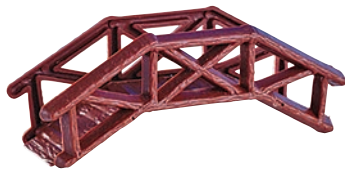

350132

11 x 4 x H: 3,5 cm · 30 u.



350134

13 x 3 cm · 144 u.



350238

4 x 4 cm · 50 u.



350251

4 x 4 cm · 50 u.



DECORACIÓN NO COMESTIBLE

Non edible decoration · Décoration non comestible · Decoração não comestível
Decorazione non commestibile

PVC · PLASTIC FIGURINES



350022

17 cm ·  36 u.



350023

17 cm ·  36 u.



350229

17 cm ·  36 u.



350145

17 cm ·  36 u.



350027

17 cm ·  144 u.



350030

12 cm ·  36 u.



350235

8,5 cm ·  144 u.



350039

Ø 2,3 cm ·  144 u.



350230

26,5 cm ·  24 u.



350059

12,5 x 7 x 5 cm ·  24 u.



350231

11 x 11 cm ·  36 u.



350236

5,5 cm ·  144 u.



350207

Ø 8 x 7 cm ·  12 u.



DECORACIÓN NO COMESTIBLE

Non edible decoration · Décoration non comestible · Decoração não comestível
Decorazione non commestibile

PVC · PLASTIC FIGURINES



350208

7,5 cm · 144 u.



350129

11,5 cm · 144 u.



x 4 x 4 x 4

301029

11 cm

x 12 x 12 u.



350136

2 cm · 144 u.



350135

4 x 5 cm · 144 u.



350131

8,5 / 9 cm.

144 u.



354146

9 / 9,5 cm.

72 u.



354145

5 cm · x 72 u.



350209

5 x 5 cm · x 144 u.



354144

5 cm.

72 u.



354074

4 cm.

144 u.



DECORACIÓN NO COMESTIBLE

Non edible decoration · Décoration non comestible · Decoração não comestível
Decorazione non commestibile

COIN BANKS · TIRELIRES · MEALHEIROS · SALVADANAÍ



203085

Bob Esponja con piruletas/
with lollipops / avec sucettes
com pirulitos / con lecca-lecca
28 g ·  6 u.



204011

Spider-Man con oblea/
with wafer / avec azyne /
com obreia / con cialda
10 g ·  6 u.



DECORACIÓN NO COMESTIBLE

Non edible decoration · Décoration non comestible · Decoração não comestível
Decorazione non commestibile

COIN BANKS · TIRELIRES · MEALHEIROS · SALVADANAÍ



x4

Peppa PigTM

204001

Peppa Pig con piruletas/
with lollipops / avec
sucettes / com pirulitos /
con lecca-lecca
28 g ·  6 u.



204018

Unicornio con caramelos
with candies / avec
bonbons / com doces /
con caramelle
30 g ·  4 u.



DECORACIÓN NO COMESTIBLE

Non edible decoration · Décoration non comestible · Decoração não comestível
Decorazione non commestibile

COIN BANKS · TIRELIRES · MEALHEIROS · SALVADANAÍ

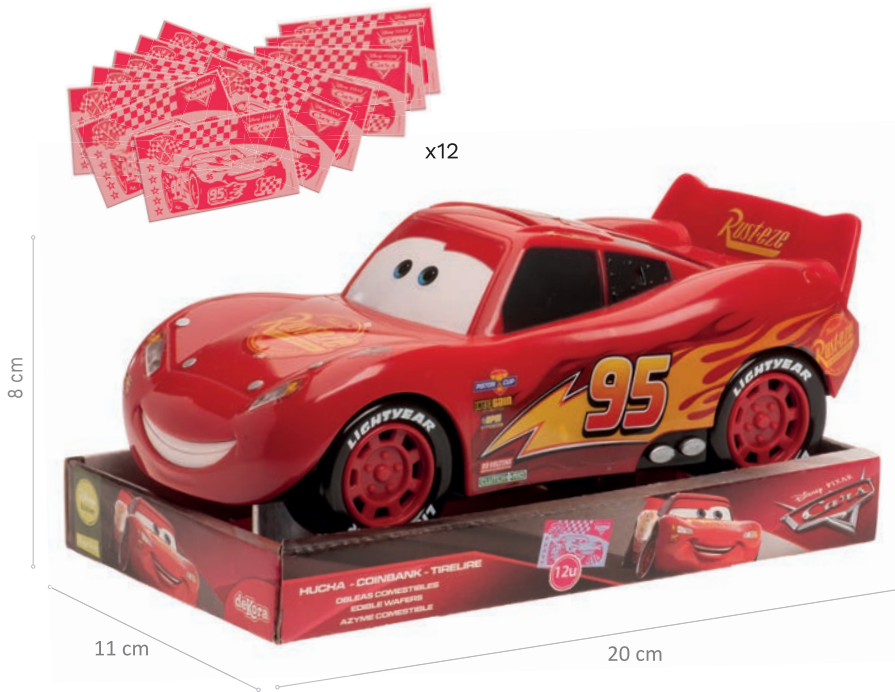

204012

Cars con oblea/
with wafer / avec azyme /
com obreia / con cialda
10 g · 6 u.



x12

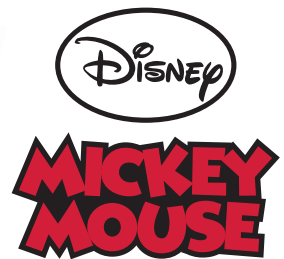

204009

Mickey Mouse con oblea/
with wafer / avec azyme /
com obreia / con cialda
10 g · 6 u.



DECORACIÓN NO COMESTIBLE

Non edible decoration · Décoration non comestible · Decoração não comestível
Decorazione non commestibile

CAKE TOPPERS

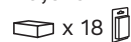

359011
MICKEY & MINNIE
16,5 cm

 x 18



DECORACIÓN NO COMESTIBLE

Non edible decoration · Décoration non comestible · Decoração não comestível
Decorazione non commestibile

CAKE TOPPERS



359012
PAW PATROL
16,5 cm
📦 x 18 📦



359013
TESIA
16,5 cm
📦 x 18 📦



DECORACIÓN NO COMESTIBLE

Non edible decoration · Décoration non comestible · Decoração não comestível
Decorazione non commestibile

CAKE TOPPERS



359000
FROZEN

🍷 x 30 u.

📦 x 12 📦



359001

PAW PATROL

🍷 x 30 u.

📦 x 12 📦



DECORACIÓN NO COMESTIBLE

Non edible decoration · Décoration non comestible · Decoração não comestível
Decorazione non commestibile

CAKE TOPPERS



359008

MICKEY

🍷 x 30 u.

📦 x 12 📦



359009

MINNIE

🍷 x 30 u.

📦 x 12 📦



359010

TESIA

🍷 x 30 u.

📦 x 12 📦



DECORACIÓN NO COMESTIBLE

Non edible decoration · Décoration non comestible · Decoração não comestível
Decorazione non commestibile

CUPCAKE CAPSULES + KITS · CAISSETES CUPCAKES + KITS
CÁPSULAS CUPCAKES + KITS · CAPSULE DI CUPCAKE + KITS



Tesia & friends

339252
TESIA

x 6



x 12 u.



x 12 u.



x 12 u.



x 12 u.

Disney
MICKEY
AND FRIENDS

339269
MICKEY AND FRIENDS

x 6



x 12 u.



x 12 u.



x 24 u.

DECORACIÓN NO COMESTIBLE

Non edible decoration · Décoration non comestible · Decoração não comestível
Decorazione non commestibile

CUPCAKE CAPSULES · CAISSETES CUPCAKES · CÁPSULAS CUPCAKES · CAPSULE DI CUPCAKE



339264
MINNIE



339260
PEPPA PIG



339240
CINDERELLA



339262
FROZEN II



339263
MICKEY



339267
CARS



339257
PJ MASKS



339258
PAW PATROL



339255
FAST FOOD



339265
FOOTBALL



339237
LOONEY TUNES



339261
SPIDER-MAN



All our range of Cupcake Capsules is suitable for food contact. - Toda nuestra selección de Cápsulas Cupcakes + Kits es apta para el contacto alimentario. - Toute notre sélection de Caissettes Cupcakes est adaptée au contact alimentaire. - A nossa seleção de Capsulas Cupcakes é adequada para contato alimentar. - La nostra selezione di capsule cupcake + kit è idonea al contatto con alimenti.

DECORACIÓN NO COMESTIBLE

Non edible decoration · Décoration non comestible · Decoração não comestível
Decorazione non commestibile

CUPCAKE CAPSULES · CAISSETES CUPCAKES · CÁPSULAS CUPCAKES · CAPSULE DI CUPCAKE



339264
MINNIE

Ø 5 x H: 3 cm.

☞ x 8 ☞ x 25 u.



339260
PEPPA PIG

Ø 5 x H: 3 cm.

☞ x 8 ☞ x 25 u.

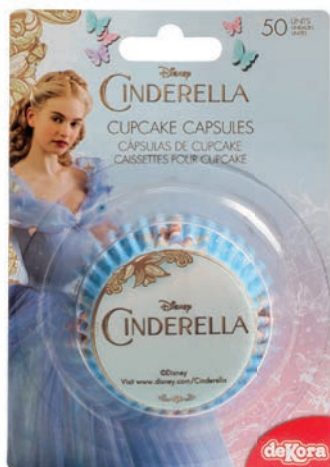

339240
CINDERELLA

Ø 5 x H: 3 cm.

☞ x 8 ☞ x 50 u.



339262
FROZEN II

Ø 5 x H: 3 cm.

☞ x 8 ☞ x 25 u.



DECORACIÓN NO COMESTIBLE

Non edible decoration · Décoration non comestible · Decoração não comestível
Decorazione non commestibile

CUPCAKE CAPSULES · CAISSETES CUPCAKES · CÁPSULAS CUPCAKES · CAPSULE DI CUPCAKE



339263
MICKEY

Ø 5 x H: 3 cm.
x 8 x 25 u.



339267
CARS

Ø 5 x H: 3 cm.
x 8 x 25 u.



339257
PJ MASKS

Ø 5 x H: 3 cm.
x 8 x 25 u.



339258
PAW PATROL

Ø 5 x H: 3 cm.
x 8 x 25 u.



DECORACIÓN NO COMESTIBLE

Non edible decoration · Décoration non comestible · Decoração não comestível
Decorazione non commestibile

CUPCAKE CAPSULES · CAISSETES CUPCAKES · CÁPSULAS CUPCAKES · CAPSULE DI CUPCAKE



339255
FAST FOOD
Ø 5 x H: 3 cm.
x 8 x 25 u.



339265
FOOTBALL
Ø 5 x H: 3 cm.
x 8 x 25 u.



DECORACIÓN NO COMESTIBLE

Non edible decoration · Décoration non comestible · Decoração não comestível
Decorazione non commestibile

CUPCAKE CAPSULES · CAISSETES CUPCAKES · CÁPSULAS CUPCAKES · CAPSULE DI CUPCAKE

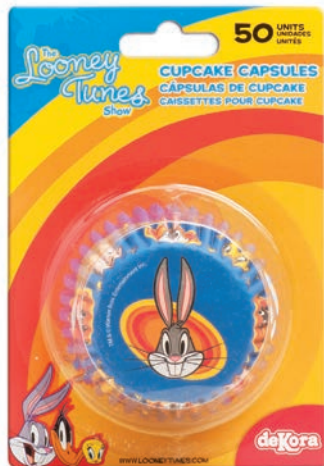

339237
LOONEY TUNES

Ø 5 x H: 3 cm.

☞ x 8 ☞ x 50 u.



339261
SPIDER-MAN

Ø 5 x H: 3 cm.

☞ x 8 ☞ x 25 u.



DECORACIÓN NO COMESTIBLE

Non edible decoration · Décoration non comestible · Decoração não comestível
Decorazione non commestibile

Cubre tu tarta y sopla las velas de forma segura e higiénica

Cover your cake and blow out the candles safely and hygienically



Disney
JUNIOR
MICKEY

354124

MICKEY AND FRIENDS

Ø 25 cm · H: 12 cm ·  x 1 u.



MARVEL
AVENGERS

354134

AVENGERS

Ø 25 cm · H: 12 cm ·  x 1 u.



Cubre-Tartas
Cake-Cover

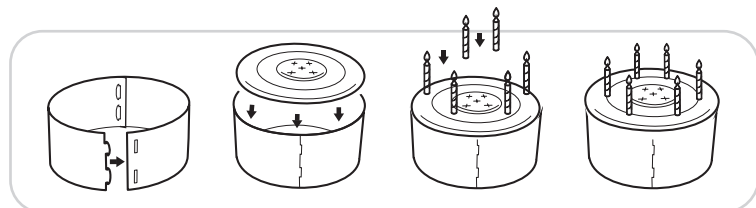

Velas no incluidas - Candles not included

deKora



CAKE TOPPERS



CAKE TOPPERS

PLÁSTICO · PLASTIC · PLASTIQUE · PLÁSTICO · PLASTICA

Felicidades



NEW

354154

11 x 14 cm

☎ x 6



Parabens



NEW

354157

11 x 14 cm

☎ x 6



Joyeux Anniversaire



NEW

354158

10 x 16 cm

☎ x 6



Happy Birthday



354136

18 x 10 cm · ☎ x 6



Happy Birthday



354112

*Oro efecto espejo
Gold mirror effect

15,4 x 10 cm · ☎ x 6



Congrats Grad



354114

13,2 x 11,3 cm · ☎ x 6

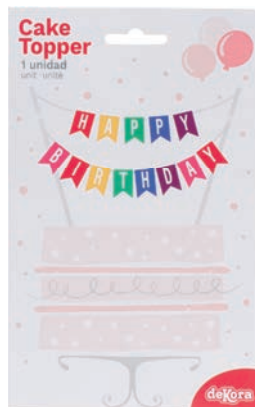

350158

19 cm · ☎ 24 u.



CAKE TOPPERS

PLÁSTICO · PLASTIC · PLASTIQUE · PLÁSTICO · PLASTICA

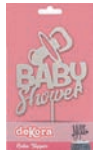

354108
 *Plata efecto espejo
 Silver mirror effect
 16 x 10 cm · 6 x 6



NEW **354151**
 17 x 10 cm · 6 x 6



354119
 16 x 6 cm · 6 x 6



354111
 15 x 9,8 cm · 6 x 6



NEW **354162**
 10 x 15,6 cm · 6 x 6



NEW **354161**
 10 x 14,3 cm · 6 x 6



CAKE TOPPERS

PLÁSTICO - METAL · PLASTIC - METAL · PLASTIQUE - METAL · PLÁSTICO - METAL · PLASTICA - METAL



NEW **354156**
PLÁSTICO
 Plastic - Plastique
 Plastica
 12 x 15 cm · x 6



NEW **354160**
PLÁSTICO
 Plastic - Plastique
 Plastica
 10 x 16 cm · x 6



354113
PLÁSTICO
 Plastic - Plastique - Plastica
 13,5 x 10 cm · x 6



354120
PLÁSTICO
 Plastic - Plastique - Plastica
 16 x 10 cm · x 6



305098
METAL
 14,5 cm · x 2 u.
 © Dekora



305070
METAL
 19 x 19 cm · x 2 u.
 © Dekora



CAKE TOPPERS

METAL



305109

18 cm ·  x  1 u.

© Dekora



NEW

305115

18 cm ·  x  1 u.

© Dekora



305102

18 cm ·  x  1 u.

© Dekora



305107

18 cm ·  x  1 u.

© Dekora



305097

18 cm ·  x  2 u.

© Dekora



305100

18 cm ·  x  2 u.

© Dekora



CAKE TOPPERS

PLÁSTICO · PLASTIC · PLASTIQUE · PLÁSTICO · PLASTICA



354107

*Plata efecto espejo
Silver mirror effect
16 x 10 cm · 6 u.



354106

*Oro efecto espejo
Gold mirror effect
16 x 10 cm · 6 u.



305062

20 x 16 cm
2 x 2 u.
© Dekora



305063

20 x 16 cm
2 x 2 u.
© Dekora



305199

10 cm · 6 u.
© Dekora



354109

*Oro efecto espejo
Gold mirror effect
16,5 x 9,9 cm · 6 u.



CAKE TOPPERS

PLÁSTICO · PLASTIC · PLASTIQUE · PLÁSTICO · PLASTICA



354150

16 x 11 cm · 6 x 6

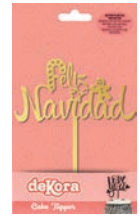

354155

11 x 14 cm · 6 x 6



354135

16,5 x 10 cm

6 x 6



354116

16,5 x 10 cm

6 x 6



CAKE TOPPERS



359000

FROZEN

Q x 30 u.

☞ x 12 ☞



359001

PAW PATROL

Q x 30 u.

☞ x 12 ☞



CAKE TOPPERS



359008
MICKEY
 x 30 u.
 x 12



359009
MINNIE
 x 30 u.
 x 12



359010
TESIA
 x 30 u.
 x 12



CAKE TOPPERS

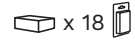

359011
MICKEY & MINNIE
16,5 cm

 x 18





359012
PAW PATROL
16,5 cm

📦 x 18



359013
TESIA
16,5 cm

📦 x 18



CAKE TOPPERS



354121
11,5 cm
x 4 u.
© Dekora



354122
12 x 11,5 cm
x 4 u.
© Dekora



Envasado individual



=



Individual packaging



354129
12 x 12,5 cm · x 4 u.



354130
12 x 12,5 cm · x 4 u.



354125
12 x 12,5 cm · x 4 u.
© Dekora



NEW **354128**
12 x 12,5 cm · x 4 u.



deKora



VELAS + BENGALAS

Candles + Sparkles · Bougies + Bougies fontaines
Velas + foguetes · Candele + Bengala

Doble deseo

Double wish

Vela Solidaria / Solidarity candle



MECHAS DESEOS **2** WICKS WISHES

Sopla una mecha por ti y otra por un niño con una enfermedad grave.

Doble deseo.
Doble ilusión.

Blow out one wick for yourself and other for a child with a serious illness.

Double wish.
double illusion.



NEW **345412**
9,5 cm ·  x 8 u.





Doble deseo

Double wish

Vela Solidaria / Solidarity candle



A veces cumplir el deseo de un niño es su mejor medicina.

La Fundación Pequeño Deseo y Dekora se han unido para crear unas velas muy especiales con 2 mechas (doble deseo). Estas velas tienen una condición muy importante, y es que cada vez que se soplen las 2 mechas, al menos 1 deseo se va a cumplir seguro, ya que, con el dinero recaudado ayudaremos a la Fundación Pequeño Deseo a que pueda seguir mejorando el estado anímico de niños y niñas con enfermedades graves a través del cumplimiento de su mayor deseo y así ayudarles a afrontar con más fuerza su tratamiento.

Sometimes fulfilling a child's wish is his best medicine.

The Pequeño Deseo Foundation and Dekora have joined forces to create very special candles with 2 wicks (double wish). These candles come with a very important condition, and that is that every time both wicks are blown out, at least 1 wish will come true for sure, as the money raised will help the Pequeño Deseo Foundation continue to improve the emotional well-being of children with serious illnesses by fulfilling their greatest wish and thus helping them better cope with their treatment.

NEW 6 X 6 cm · x 12 u.

345451

345452

345453

345454

345455

345456

345457

345458

345459

345450

VELAS

Candles · Bougies · Candele

2D



345417
HAPPY BIRTHDAY II
10 x 6 cm ·  x 12 u.



345415
HAPPY BIRTHDAY
10 x 6,5 cm ·  x 12 u.



VELAS

Candles · Bougies · Candele

2D



345406
MI PRIMER CUMPLE
7,5 cm ·  x 12 u.



345403
BABY 2D
4,2 - 4,4 cm ·  x 8 u.



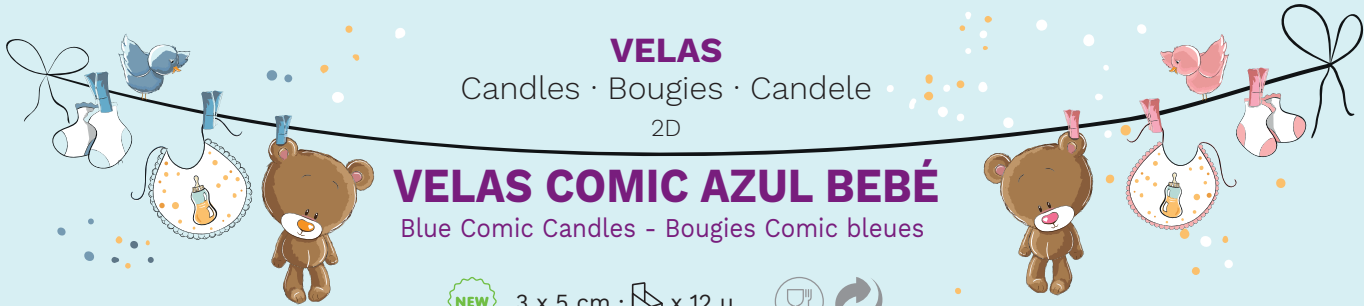

VELAS
Candles · Bougies · Candeles
2D

VELAS COMIC AZUL BEBÉ

Blue Comic Candles - Bougies Comic bleues



3 x 5 cm · x 12 u.



345430

345431

345432

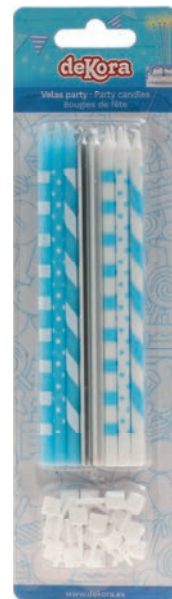

345448

13 cm · x 12 u.





VELAS

Candles · Bougies · Candele

2D

VELAS COMIC ROSA BEBÉ

Pink Comic Candles - Bougies Comic roses



3 x 5 cm · x 12 u.



345414

345418

345419



345447

13 cm · x 12 u.



VELAS

Candles · Bougies · Candele

2D



346223
MICKEY 2D
7,5 cm ·  x 12 u.



346224
MINNIE 2D
6,5 cm ·  x 12 u.



346243
MICKEY AND
FRIENDS 2D
Ø 3 cm ·  x 12 u.



346173
DISNEY
9 cm ·  x 12  x 8 u.



VELAS

Candles · Bougies · Candeles

3D



346028
MINNIE 3D
8 cm ·  x 6 u.



346141
MICKEY 3D
6,5 cm ·  x 8 u.



346027
MICKEY 3D
8 cm ·  x 6 u.



VELAS

Candles · Bougies · Candele

2D



HELLO KITTY



346220
HELLO KITTY 2D
7 cm ·  x 12 u.



346203
SHIMMER & SHINE 2D
7,5 cm ·  x 12 u.



VELAS

Candles · Bougies · Candele

2D



NEW **345413**
TESIA 2D
7,5 cm ·  x 12 u.



345408
MIX VELAS UNICORNIO 2D
3 - 5 cm ·  x 12  x 15 u.



(x 12 u.)



Tesia & friends



345405
TESIA 2D
8 x 6,2 cm ·  x 8 u.



VELAS

Candles · Bougies · Candeles

2D / 3D



346233

PEPPA PIG 2D

7 cm ·  x 12 u.



Peppa PigTM



346089

PEPPA PIG 3D

7,5 cm ·  x 6 u.



VELAS

Candles · Bougies · Candele

2D



346248

PEPPA PIG 2D

4,4 - 5 cm ·  x 8 u.



346198

HERO GIRLS 2D

7,5 cm ·  x 12 u.



VELAS

Candles · Bougies · Candele

2D / 3D





Disney
CINDERELLA

346127
CINDERELLA 2D

8 cm ·  x 12 u.



346175
DISNEY PRINCESS
9 cm ·  x 12  x 8 u.



346194
CENICIENTA 3D

5,5 cm ·  x 8 u.



VELAS

Candles · Bougies · Candele

2D / 3D



346002

BELLA 2D

7,5 cm ·  x 12 u.



Disney
PRINCESS



346206

BELLA 3D

5,5 cm ·  x 8 u.



VELAS

Candles · Bougies · Candele

2D

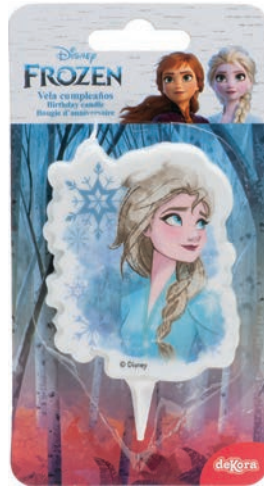

346228
FROZEN 2D
7 cm ·  x 12 u.



Disney
FROZEN



346227
FROZEN 2D
7,5 cm ·  x 12 u.



VELAS



Candles · Bougies · Candele

2D / 3D



346174

FROZEN

9 cm ·  x 12  x 8 u.



Disney
FROZEN



346244

FROZEN 2D

Ø 3 cm ·  x 12 u.



VELAS

Candles · Bougies · Candeles

2D / 3D



346249
PAW PATROL 2D
4,2 - 4,4 cm ·  x 8 u.

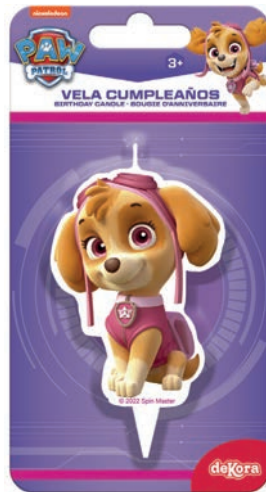

346171
SKYE 2D
7,5 cm ·  x 12 u.



346181
SKYE 3D
7 cm ·  x 6 u.



VELAS

Candles · Bougies · Candele

2D



346245
PAW PATROL 2D
Ø 3 cm ·  x 12 u.



346226
PAW PATROL 2D
7 cm ·  x 12 u.



346170
PAW PATROL 3D
7 cm ·  x 6 u.



VELAS

Candles · Bougies · Candele

2D



345386
DINOSAURIO 2D
7,5 cm · x 12 u.



345407
MIX VELAS DINOSAURIO 2D
3 - 5 cm · x 12 x 15 u.



(x 12 u.)



345404
DINOS 2D
3,3 - 5 cm · x 8 u.



VELAS

Candles · Bougies · Candele

2D / 3D



346215
CARS 2D

7,5 cm ·  x 12 u.



346053
CARS 3D

8,5 x 6 cm ·  x 6 u.



346204
PJ MASK 2D

7,5 cm ·  x 12 u.



VELAS



Candles · Bougies · Candeles

2D / 3D



346193

SPIDER-MAN

9 cm ·  x 12  x 8 u.

MARVEL
SPIDER-MAN



MARVEL
SPIDER-MAN

346208

SPIDER-MAN 2D

7 cm ·  x 12 u.



MARVEL
SPIDER-MAN

346205

SPIDER-MAN 3D

9 cm ·  x 6 u.



VELAS

Candles · Bougies · Candele



2D



AVENGERS



346192
AVENGERS

9 cm ·  x 12  x 8 u.



AVENGERS

346185
CAPTAIN
AMERICA 2D
7,5 cm ·  x 12 u.



AVENGERS

346221
HULK 2D
7,5 cm ·  x 12 u.



VELAS

Candles · Bougies · Candeles



NEW **345449**
2D
7,5 cm ·  x 12 u.



345255
2D
7 cm ·  x 12 u.



345256
2D
7 cm ·  x 12 u.



345257
2D
7 cm ·  x 12 u.



345260
2D
7 cm ·  x 12 u.



VELAS

Candles · Bougies · Candeles



345261

2D

7 cm · x 12 u.



345262

2D

7 cm · x 12 u.



345263

2D

7 cm · x 12 u.



345264

2D

7 cm · x 12 u.



345265

2D

7 cm · x 12 u.



345266

2D

7 cm · x 12 u.



VELAS

Candles · Bougies · Candele

2D / 3D



NEW

345375

2D

x 12 x 12 u.



345315

x 12 x 12 u.



345335

3D

3 - 5 cm

x 12 x 6 u.



VELAS

Candles · Bougies · Candele

2D



345338

8 x 6 cm ·  x 12 u.



345398

6,3 cm ·  x 12 u.



345399

6,3 cm ·  x 12 u.



345400

6,3 cm ·  x 12 u.



345401

6,3 cm ·  x 12 u.



345402

6,3 cm ·  x 12 u.



VELAS

Candles · Bougies · Candele

3D

LA VELA QUE NO SE APAGA

The candle that never goes out
La bougie qui ne s'éteint jamais
A vela que nunca sai
La candela che non si spegne mai



345310
VELA MÁGICA
Magic candle
Bougie magique
Candela magica
x 18 x 10 u.



345311

(50A + 50B)
A: Rosa - Pink - Rose
B: Azul - Blue - Bleu



345309

x 12 x 24 u.



345333

VELAS LLAMA DE COLOR
Colour flame candles
Bougies a flamme colorée
Velas chama de cores
Candele con fiamma colorata
6 cm x 12 x 6 u.



VELAS

Candles · Bougies · Candele



NEW 345443
10 cm ·  x 12 u.



NEW 345444
12 cm ·  x 12 u.



NEW 345446
2,3 x 3,3 cm
 x 12 u.



VELAS

Candles · Bougies · Candele

VELAS GIGANTES

Giant candles - Bougies géantes - Candele giganti



New base perfect position

Nueva base. Posición perfecta

Nouvelle base. Position parfaite

Nuova base.
Posizione perfetta

15 cm ·  x 6 u.



15 cm



VELAS

Candles · Bougies · Candele



15 cm ·  x 6 u.



345278



345279



345280



345281



345282



345283



345284



345285



345286



345277



VELAS

Candles · Bougies · Candele

VELAS PURPURINA ROSA

Pink glitter candles - Bougies à paillettes couleur roses - Velas com purpurina e rosa
Candela porporina rosa

7 cm ·  x 12 u.  

6,8 cm



345340



345341



345342



345343



345344



345345



345346



345347



345348



345349



15,6 cm

9,8 cm



8,8 cm

14,9 cm

VELAS

Candles · Bougies · Candele

VELAS PURPURINA ORO

Golden glitter candles - Bougies à paillettes couleur or - Velas com purpurina e ouro
Candela porporina oro

13 cm ·  x 10 u.  



13 cm

345351

345352

345353

345354

345355

345356

345357

345358

345359

345360

23,5 cm

18,5 cm

11 cm

22,3 cm

10 cm

VELAS

Candles · Bougies · Candele

VELAS COMIC

Comic Candles - Bougies Comic

5,5 x 3 cm ·  x 12 u.  



345172



345173



345174



345175



345176



345177



345178



345179



15 cm

8,3 cm



345180



345181





345055

VELAS

Candles · Bougies · Candele

VELAS COMIC ORO

Gold Comic Candles - Bougies Comic D'or

5,5 x 3 cm ·  x 12 u.  



345420



345421



345422



345423



345424



345425



345426



345427



345428



345429



15 cm

8,3 cm





VELAS

Candles · Bougies · Candele

VELAS FLUORESCENTES

Fluorescent candles - Bougies fluorescent - Candele fluorescenti

6 cm ·  x 12 u.  

6 cm



345267



345268



345269



345270

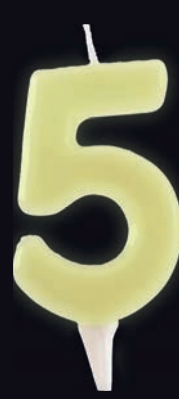

345271



345272



345273



345274



345275



345276





VELAS

Candles · Bougies · Candele

VELAS HELVET

Helvet Candles - Bougies Helvet

4,5 x 3,5 cm ·  x 12 u. 

4,5 cm



345075



345076



345077



345078



345079



345080



345081



345082



345083



345084





VELAS

Candles · Bougies · Candele

VELAS BENGALA

Sparkler candles - Bougies fontaine - Velas foguete - Candele bengala

12 cm  x 12 u.  



345299

12 cm  x 12 u.



345300

12 cm  x 12 u.



345301

12 cm  x 12 u.



345302

12 cm  x 12 u.



345303

12 cm  x 12 u.



345304

12 cm  x 12 u.



345305

12 cm  x 12 u.



345306

12 cm  x 12 u.



345307

12 cm  x 12 u.



345308

12 cm  x 12 u.



2,2 g de pólvora
gunpowder / poudre / polvere x u.



Apto para contacto alimentario - Suitable for food contact - Adapté au contact alimentaire - Adequado para contato alimentar - Idoneo al contatto con alimenti

NUEVAS VELAS DE CUMPLEAÑOS CHISPEANTES

Gold birthday candles sparkling - Bougies d'anniversaire pétillantes or
Velas de aniversário de ouro espumante - Candele di compleanno in oro scintillante



0,17 g pólvora - Gunpowder
Poudre - Polvere x u. 12 cm x 10 u.



1.4S



±20 s.



345433



345434



345436



345436



345437



345438



345439



345440



345441



345442



2 IN 1
DUO



BENGALA



VELA

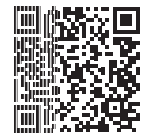

YouTube



VELAS

Candles · Bougies · Candele

BENGALAS

Candle sparkler - Fontaine lumineuse - Foguete



1.4S



± 45 s.

316004

4,1 g pólvora - Gunpowder
Poudre - Polvere x u.

12 cm · x 12 u.



1.4S



± 45 s.

345372

4,1 g pólvora - Gunpowder
Poudre - Polvere x u.

12 cm x 12 x 2 u.

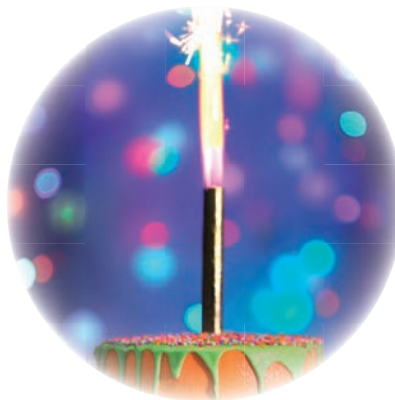

1.4S



± 55 s.

345015

4,1 g pólvora - Gunpowder
Poudre - Polvere x u.

12 cm · x 10 u.



Apto para contacto alimentario - Suitable for food contact - Adapté au contact alimentaire - Adequado para contato alimentar - Idoneo al contatto con alimenti

VELAS

Candles · Bougies · Candele

BENGALAS

Candle sparkler - Fontaine lumineuse - Foguete



1.4S



± 60 s.

345411

4,1 g pólvora - Gunpowder

Poudre - Polvere x u.

12 cm ·  x 60 u.





VELAS

Candles · Bougies · Candele



316001 *

0,5 g de pólvora - Gunpowder - Poudre - Polvere x u.

17 cm  x 25  x 12 u



 **No apto para el contacto alimentario***

 Not suitable for food contact*

 Non apte au contact alimentaire*

 Não apto para o contacto alimentar*

 Non idoneo al contatto con alimenti*



1.4S

± 35 s.



1.4S

± 35 s.

316000 *

0,5 g de pólvora - Gunpowder - Poudre
Polvere x u.

17 cm ·  x 120 u.



No apto para el contacto alimentario*



Not suitable for food contact*



Non apte au contact alimentaire*



Não apto para o contacto alimentar*



Non idoneo al contatto con alimenti*



1.4S

± 35 s.

316002 *

1 g de pólvora - Gunpowder - Poudre
Polvere x u.

13,5 cm ·  x 20 u.



No apto para el contacto alimentario*



Not suitable for food contact*



Non apte au contact alimentaire*



Não apto para o contacto alimentar*



Non idoneo al contatto con alimenti*

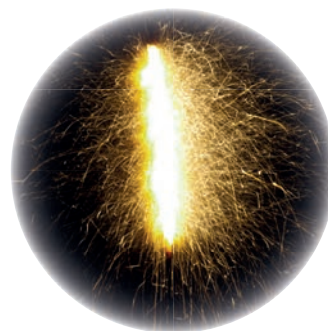

VELAS

Candles · Bougies · Candele



316003 *

0,5 g de pólvora - Gunpowder - Poudre
Polvere x u.

17 cm ·  x 25  x 8 u.



 **No apto para el contacto alimentario***

 **Not suitable for food contact***

 **Non apte au contact alimentaire***

 **Não apto para o contacto alimentar***



 **Non idoneo al contatto con alimenti***



345410 *

1 g pólvora
Gunpowder
Poudre

Polvere x u.

13,5 cm ·  x 12  x 4 u.



 **No apto para el contacto alimentario***

 **Not suitable for food contact***

 **Non apte au contact alimentaire***

 **Não apto para o contacto alimentar***

 **Non idoneo al contatto con alimenti***

VELAS



Candles · Bougies · Candele

VELAS METÁLICAS

Metallic candles - Bougies métalliques - Candele metalliche





345329

13 cm  x 12  x 16 u.





345330

13 cm
 x 12  x 16 u.



345332

13 cm
 x 12  x 16 u.



deKora



EVENTOS

Events · Évènements · Eventos · Eventi

BODA

Weddings · Mariage · Nozze

RESINA · RESIN · RÉSINE · RESINA



305111

16 cm ·  x  1 u.

© Dekora

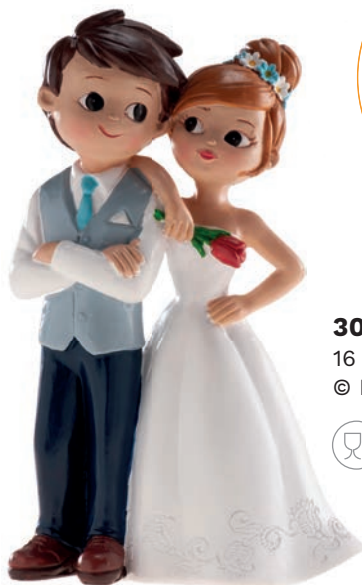

305113

16 cm ·  x  1 u.

© Dekora



305101

16 cm ·  x  1 u.

© Dekora



305103

16 cm ·  x  2 u.

© Dekora



BODA

Weddings · Mariage · Nozze

RESINA · RESIN · RÉSINE · RESINA



305080

16 cm ·  x  1 u.

© Dekora



305081

16 cm ·  x  1 u.

© Dekora



305104

16 cm ·  x  1 u.

© Dekora



305072

12 cm ·  x  2 u.

© Dekora



BODA

Weddings · Mariage · Nozze

RESINA · RESIN · RÉSINE · RESINA



305108

16 cm ·  x  1 u.

© Dekora

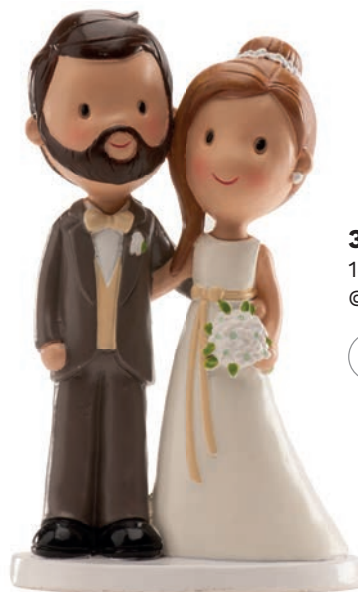

305074

14 cm ·  x  2 u.

© Dekora



CLAY · HECHO A MANO · HAND MADE · FAIT À LA MAIN · FEITO A MÃO · FATTO A MANO



305052

CLAY

13 cm ·  2 u.

© Dekora



305030

CLAY

14 cm ·  2 u.

© Dekora



BODA

Weddings · Mariage · Nozze

RESINA · RESIN · RÉSINE · RESINA



305082

16 cm ·  x  2 u.

© Dekora



305086

16 cm ·  x  2 u.

© Dekora



305090

16 cm ·  x  2 u.

© Dekora



305083

16 cm ·  x  2 u.

© Dekora



305088

16 cm ·  x  2 u.

© Dekora



305087

16 cm ·  x  2 u.

© Dekora



BODA

Weddings · Mariage · Nozze

RESINA · RESIN · RÉSINE · RESINA

Envasado individual



=



Individual packaging



305065

20 cm ·  x  2 u.

© Dekora



305010

20 cm ·  x  2 u.

© Dekora



305001

20 cm ·  x  2 u.

© Dekora



305068

20 cm ·  x  1 u.

© Dekora



305067

20 cm ·  x  2 u.

© Dekora





BODA

Weddings · Mariage · Nozze

RESINA · RESIN · RÉSINE · RESINA



305133

18 x 19 cm ·  x  1 u.

© Dekora



305066

20 cm ·  x  2 u.

© Dekora



305000

16 cm ·  x  2 u.

© Dekora



305058

18 cm ·  x  2 u.

© Dekora



305060

18 cm ·  x  2 u.

© Dekora



BODA

Weddings · Mariage · Nozze

RESINA · RESIN · RÉSINE · RESINA



305045

16 cm ·  x  2 u.

© Dekora

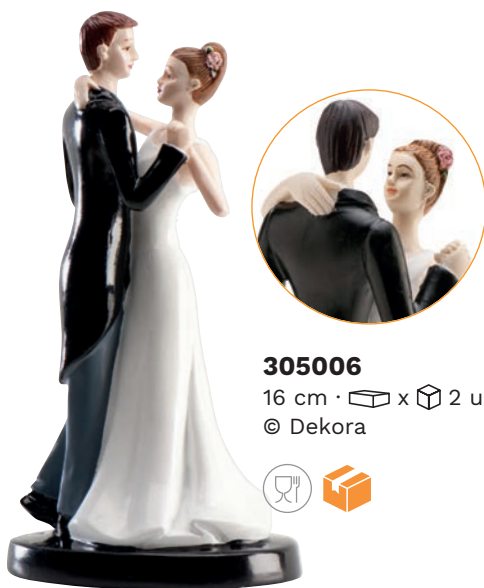

305006

16 cm ·  x  2 u.

© Dekora



305096

16 cm ·  x  2 u.

© Dekora



305073

16 cm ·  x  2 u.

© Dekora



BODA

Weddings · Mariage · Nozze

RESINA · RESIN · RÉSINE · RESINA



305069

18 x 15 cm ·  x  2 u.

© Dekora



305093

18 cm ·  x  2 u.

© Dekora



305226

17 cm ·  x  2 u.

© Dekora



BODA

Weddings · Mariage · Nozze

RESINA · RESIN · RÉSINE · RESINA



305054

20 cm ·  x  2 u.

© Dekora



305008

20 cm ·  x  1 u.

© Dekora



305217

EFFECTO PORCELANA

Porcelain effect

Effet porcelaine

Efeito porcelana

Effetto porcellanato

21 cm ·  1 u.

© Dekora



305224

20 cm ·  x  1 u.

© Dekora



BODA

Weddings · Mariage · Nozze





305057
METAL
18 cm ·  2 u.
© Dekora



305056
METAL
18 cm ·  2 u.
© Dekora





306001
CLAY
12,5 cm ·  x 5 
© Dekora





CAKE TOPPER METAL



305098
14,5 cm ·  x  2 u.
© Dekora



305070
19 x 19 cm ·  x  2 u.
© Dekora



BODA

Weddings · Mariage · Nozze

CAKE TOPPER METAL



305109

18 cm ·  x  1 u.

© Dekora



NEW

305115

18 cm ·  x  1 u.

© Dekora



305102

18 cm ·  x  1 u.

© Dekora



305107

18 cm ·  x  1 u.

© Dekora



305097

18 cm ·  x  2 u.

© Dekora



305100

18 cm ·  x  2 u.

© Dekora



BODA

Weddings · Mariage · Nozze

CAKE TOPPER PLÁSTICO · PLÁSTICO · PLASTIC · PLASTIQUE · PLÁSTICO · PLASTICA

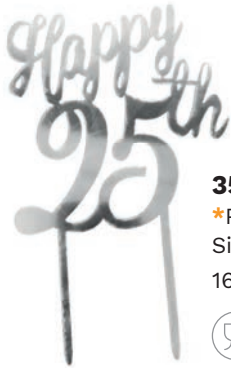

354107
 *Plata efecto espejo
 Silver mirror effect
 16 x 10 cm · 1 x 6



354106
 *Oro efecto espejo
 Gold mirror effect
 16 x 10 cm · 1 x 6



305062
 20 x 16 cm
 1 x 2 u.
 © Dekora



305063
 20 x 16 cm
 1 x 2 u.
 © Dekora



305199
 10 cm · 6 u.
 © Dekora



CINTA STRASS · RHINESTONE WITH STRASS · BANDE AVEC STRASS



319045
 H: 5 cm · 15 mts
 Blanco - White



319046
 H: 5 cm · 15 mts
 Rosa - Pink



319044
 H: 5 cm · 15 mts
 Azul - Blue



319020
 H: 3,5 cm
 10 mts
 Plata - Silver



319024
 H: 3,5 cm
 10 mts
 Azul - Blue

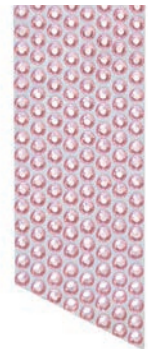

319025
 H: 3,5 cm
 10 mts
 Rosa - Pink



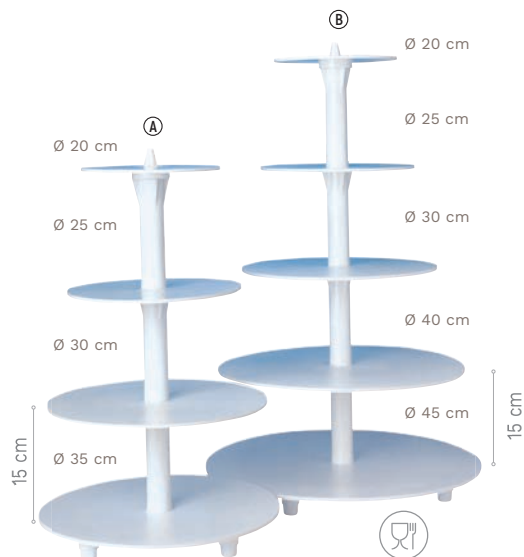

341003 (A)

PLÁSTICO - Plastic - Plastique - Plástico
4 Pisos - 4 Tiers - 4 Étages - 4 Andares - 4 piani
1 u.

341004 (B)

PLÁSTICO - Plastic - Plastique - Plástico
5 Pisos - 5 Tiers - 5 Étages - 5 Andares - 5 piani
1 u.

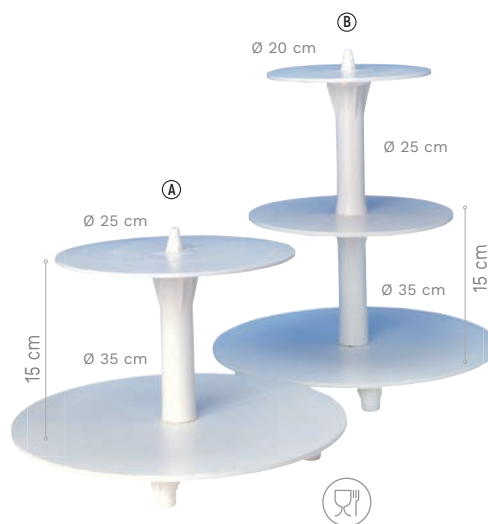

341001 (A)

PLÁSTICO - Plastic - Plastique - Plástico
2 Pisos - 2 Tiers - 2 Étages - 2 Andares - 2 piani
1 u.

341002 (B)

PLÁSTICO - Plastic - Plastique - Plástico
3 Pisos - 3 Tiers - 3 Étages - 3 Andares - 3 piani
1 u.



341125

PLÁSTICO - Plastic
Plastique - Plástico
2 Brazos - 2 Supports
2 Bras - 2 Suportes
H: 24 cm · 1 u.



341126

PLÁSTICO - Plastic
Plastique - Plástico
4 Brazos - 4 Supports
4 Bras - 4 Suportes
H: 45 cm · 1 u.



535230

BANDEJA DE EXPOSICIÓN INCLINABLE GIRATORIA

Cake Display rotatory tilting
Plateau présentoir pivotant avec inclinaison
Bandeja exposição giratório de inclinação
Vassoio da esposizione inclinabile e girevole
Ø 23 cm · 1 u.





341153

PLÁSTICO - Plastic - Plastique - Plástico

4 Brazos - 4 Supports

4 Bras - 4 Suportes

1 u.

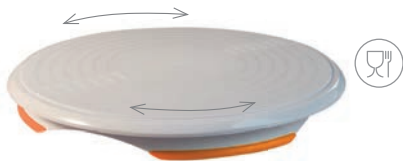

341155

BANDEJA EXPOSICIÓN - GIRATORIA

Cake display stand - ROTARY • Plateau présentoir

- PIVOTANT • Bandeja exposição - GIRATÓRIO •

Vassoio da esposizione - GIREVOLE

Ø 30,5 X H: 3,2 cm · 1 u.



535217

GIRATORIO - Rotary - Pivotant - Giratório - Girevole

Ø 32 x 10 cm · Peso / Weight: 600 g · 1 u.



BODA

Weddings · Mariage · Nozze

SOPORTES · CAKE STANDS · SUPPORTS · SUPPORTES · SUPPORTI

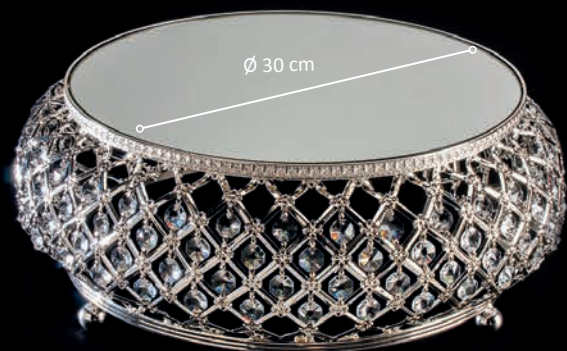

SOPORTE PLATA ESPEJO Y CRISTAL

Silver mirror and crystal support
Support argent avec miroir
Supporto argento specchio e cristallo

342018

Ø 30 x H: 15 cm

1 u.



SOPORTE CUADRADO CON DIAMANTES

Square support with diamonds
Support carré avec diamants
Supporto quadrato con diamanti

342044

21 x 21 x H: 22 cm

1 u.

342042

25 x 25 x H: 32 cm

1 u.



SOPORTE REDONDO CON DIAMANTES

Round support with diamonds
Support rond avec diamants
Supporto rotondo

342033

Ø 25 cm - H: 32 cm

1 u.

342023

Ø 30 cm - H: 33,5 cm

1 u.



MINI SOPORTE NEGRO TARTA PLEXIGLÁS

Mini black plexiglass cake stand - Mini support à gâteau noir plexiglas - Mini suporte preto para bolos plexiglas - Mini alzata nera in plexiglas per torte

(A) **341156** Ø 21 x H: 10,3 cm  1 u.

(B) **341157** Ø 21 x H: 16,3 cm  1 u.



MINI SOPORTE BLANCO TARTA PLEXIGLÁS

Mini white plexiglass cake stand - Mini support à gâteau blanc plexiglas - Mini suporte branco para bolos plexiglas - Mini alzata bianca in plexiglas per torte

(A) **341158** Ø 21 x H: 10,3 cm  1 u.

(B) **341159** Ø 21 x H: 16,3 cm  1 u.



SOPORTE CRYSTAL BARROCO PLEXIGLÁS

Crystal baroque plexiglass stand - Support crystal baroque plexiglas - Suporte crystal barroco plexiglas - Supporto crystal barocco in plexiglas

(A) **341160** Ø 26 x H: 21 cm  1 u.

(B) **341161** Ø 26 x H: 35 cm  1 u.



SOPORTE NEGRO BARROCO PLEXIGLÁS

Black baroque plexiglass stand - Support noir baroque plexiglas - Suporte preto barroco plexiglas - Supporto nero barocco plexiglas

(A) **341162** Ø 26 x H: 21 cm  1 u.

(B) **341163** Ø 26 x H: 35 cm  1 u.



BODA

Weddings · Mariage · Nozze

SOPORTES · CAKE STANDS · SUPPORTS · SUPORTES · SUPPORTI



blancas - white - blanc - branco - bianco

NEW	(A) 540360	25 x 25 cm x H: 1,2 cm	1 u.
NEW	(B) 540361	30 x 30 cm x H: 1,2 cm	1 u.

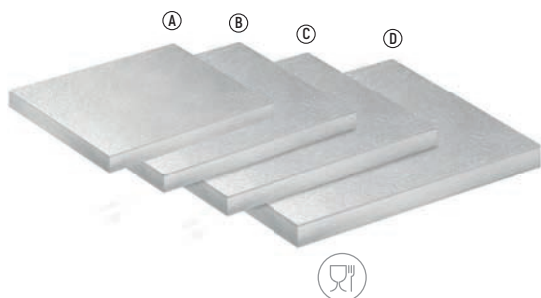

plata - silver - argent - prata - argento

NEW	(A) 540359	25 x 25 cm x H: 1,2 cm	1 u.
	(B) 540270	30 x 30 cm x H: 1,2 cm	1 u.
	(C) 540075	35,5 x 35,5 cm x H: 1,2 cm	1 u.
	(D) 540271	40 x 40 cm x H: 1,2 cm	1 u.



blancas - white - blanc - branco - bianco

NEW	(A) 540365	20 x 30 cm x H: 1,2 cm	1 u.
NEW	(B) 540367	35 x 30 cm x H: 1,2 cm	1 u.
NEW	(C) 540370	30 x 40 cm x H: 1,2 cm	1 u.

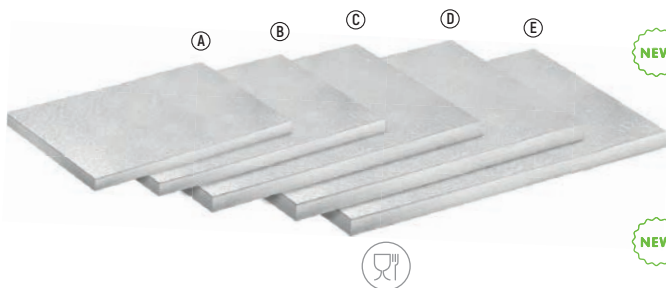

plata - silver - argent - prata - argento

NEW	(A) 540364	20 x 30 cm x H: 1,2 cm	1 u.
	(B) 540273	30 x 25 cm x H: 1,2 cm	1 u.
	(C) 540272	35 x 25 cm x H: 1,2 cm	1 u.
	(D) 540277	35 x 30 cm x H: 1,2 cm	1 u.
NEW	(E) 540371	30 x 40 cm x H: 1,2 cm	1 u.



plata - silver - argent - prata - argento

NEW	(A) 540358 Ø 20 x H: 1,2 cm	1 u.
	(B) 540226 Ø 25 x H: 1,2 cm	1 u.
	(C) 540229 Ø 30 x H: 1,2 cm	1 u.
	(D) 540236 Ø 35 x H: 1,2 cm	1 u.
	(E) 540268 Ø 40 x H: 1,2 cm	1 u.
	(F) 540269 Ø 45 x H: 1,2 cm	1 u.



blancas - white - blanc - branco - bianco

NEW	(A) 540356 Ø 20 x H: 1,2 cm	1 u.
	(B) 540299 Ø 25 x H: 1,2 cm	1 u.
	(C) 540304 Ø 30 x H: 1,2 cm	1 u.
	(D) 540305 Ø 35 x H: 1,2 cm	1 u.
	(E) 540352 Ø 40 x H: 1,2 cm	1 u.



doradas - gold - or - oro

(A) 540306 Ø 25 x H: 1,2 cm	1 u.
(B) 540307 Ø 30 x H: 1,2 cm	1 u.
(C) 540308 Ø 35 x H: 1,2 cm	1 u.
(D) 540353 Ø 40 x H: 1,2 cm	1 u.

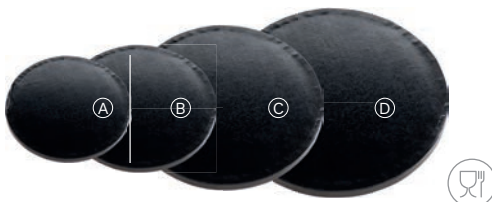

negras - black - noir - preto - nero

(A) 540309 Ø 25 x H: 1,2 cm	1 u.
(B) 540310 Ø 30 x H: 1,2 cm	1 u.
(C) 540311 Ø 35 x H: 1,2 cm	1 u.
(D) 540354 Ø 40 x H: 1,2 cm	1 u.

BODA

Weddings · Mariage · Nozze
OBLEA · WAFER · AZYME · OBREIA · CIALDA



126140
12,5 cm · 1 u.



126142
12,5 cm · 1 u.



126141
12,5 cm · 1 u.





NEW 126174
12,5 cm ·  1 u.



NEW 126172
12,5 cm ·  1 u.



NEW 126173
12,5 cm ·  1 u.



BAUTIZO

Christening · Baptême · Baptizado · Battesimo

RESINA · RESIN · RÉSINE · RESINA



310001

10 cm ·  x  6 u.

© Dekora



310002

10 cm ·  x  6 u.

© Dekora



310133

10 cm ·  x  6 u.

© Dekora



310134

10 cm ·  x  6 u.

© Dekora



BAUTIZO

Christening · Baptême · Baptizado · Battesimo

RESINA · RESIN · RÉSINE · RESINA



310142

10 cm ·  6 u.

© Dekora



310140

10 cm ·  6 u.

© Dekora



310135

10 cm ·  x  6 u.

© Dekora



310136

10 cm ·  x  6 u.

© Dekora





BAUTIZO



Christening · Baptême · Baptizado · Battesimo

RESINA · RESIN · RÉSINE · RESINA



310124
10,5 cm ·  x  6 u.
© Dekora



310123
10,5 cm ·  x  6 u.
© Dekora



310129
11 x 7 cm
 x  6 u.
© Dekora



310097
10 cm ·  6 u.



310098
10 cm ·  6 u.





BAUTIZO

Christening · Baptême · Baptizado · Battesimo

RESINA · RESIN · RÉSINE · RESINA





310114

10 x 6 cm ·  x  6 u.

© Dekora



310115

10 x 6 cm ·  x  6 u.

© Dekora



310138

10 cm ·  x  6 u.

© Dekora



310137

10 cm ·  x  6 u.

© Dekora



BAUTIZO

Christening · Baptême · Baptizado · Battesimo

RESINA · RESIN · RÉSINE · RESINA

Envasado individual



Individual packaging



310110

10 cm ·  x  4 u.

© Dekora



310111

10 cm ·  x  4 u.

© Dekora



310112

10 cm ·  x  4 u.

© Dekora



310113

10 cm ·  x  4 u.

© Dekora



310107

METAL

18 cm ·  4 u.

© Dekora



310108

METAL

18 cm ·  4 u.

© Dekora



BAUTIZO

Christening · Baptême · Baptizado · Battesimo

RESINA · RESIN · RÉSINE · RESINA





310048
14,5 cm ·  4 u.
© Dekora





310047
14,5 cm ·  4 u.
© Dekora





310105
13 x 10 cm
 x  4 u.
© Dekora



310106
13 x 10 cm
 x  4 u.
© Dekora



310103
13 x 10 cm ·  x  4 u.
© Dekora



BAUTIZO

Christening · Baptême · Baptizado · Battesimo



NEW **354161**
CAKE TOPPER
10 x 14,3 cm · 📦 x 6



NEW **354151**
CAKE TOPPER
17 x 10 cm · 📦 x 6

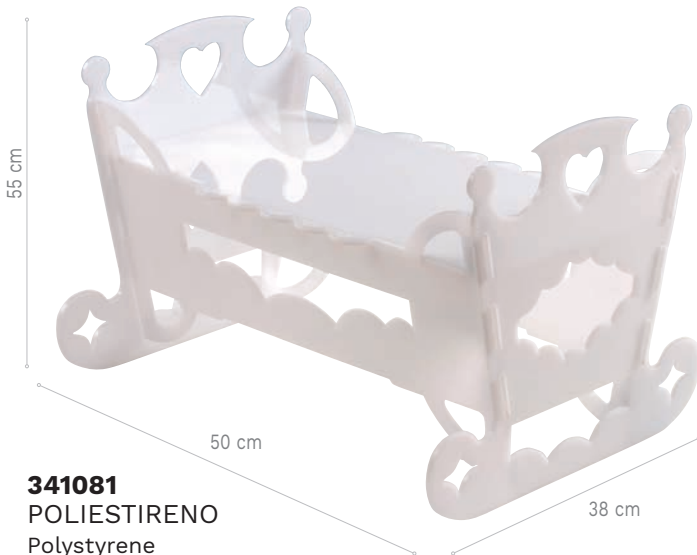

341081
POLIESTIRENO
Polystyrene
50 x 38 x H: 55 cm · 📦 1 u.



354108
CAKE TOPPER
PLÁSTICO
Plastic - Plastique
*Plata efecto espejo
Silver mirror effect
16 x 10 cm · 📦 x 6



310004
10 cm · 📦 6 u.
© Dekora

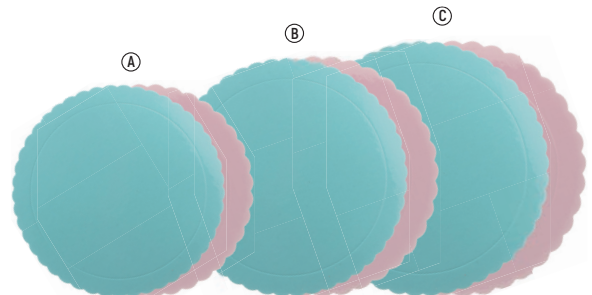

DOBLE CARA
Doble cara - Double face - Duas caras - Doppia faccia

(A)	540296	0,3 Ø 25 cm	📦 1 u.
(B)	540297	0,3 Ø 30 cm	📦 1 u.
(C)	540298	0,3 Ø 35 cm	📦 1 u.

BAUTIZO

Christening · Baptême · Baptizado · Battesimo



NEW

345447
13 cm ·  x 12 u.



NEW

345448
13 cm ·  x 12 u.



345403
BABY 3D
4,2 - 4,4 cm ·  x 8 u.



BAUTIZO

Christening · Baptême · Baptizado · Battesimo



CHOCO DRIP
AZUL

401031
AZUL
Blue - Bleu
Azul - Blu

CHOCO DRIP
ROSA

401030
ROSA
Pink - Rose
Rosa



CHOCO DRIP
AMARILLO

401032
AMARILLO
Yellow - Jaune
Amarelo - Giallo



CHOCO DRIP
180 g · 1 u.



126159
OBLEA
Wafer - Azyme
Obreia - Cialda
3 cm · 150 u.



126160
OBLEA
Wafer - Azyme
Obreia - Cialda
3 cm · 100 u.



126006
OBLEA
Wafer - Azyme
Obreia - Cialda
8 cm · 50 u.



145109
OBLEA
Wafer - Azyme - Obreia - Cialda
MINI BABY SHOWER BOY
Troqueladas - Pre-cut
Pré-découpées - Sagomati
Ø 3,4 cm. · 6 x 20



145108
OBLEA
Wafer - Azyme - Obreia - Cialda
MINI BABY SHOWER GIRL
Troqueladas - Pre-cut
Pré-découpées - Sagomati
Ø 3,4 cm. · 6 x 20



BAUTIZO

Christening · Baptême · Baptizado · Battesimo

AZÚCAR · SUGAR · SUCRE · AÇUCAR · ZUCCHERO



205056

4 - 5,5 cm

16 u. (6A + 4B + 6C)



211111

2D

A: 4,5 x 6 cm / B: 4,2 x 7 cm

C: 4,9 x 5,9 cm / D: 5,4 x 2,9 cm

E: 6 x 3,1 cm

50 u.



205190

MACARONS

72 u.





COMUNIÓN



Holy Communion · Communion · Comunhão · Comunione

RESINA · RESIN · RÉSINE · RESINA





315117
16 cm ·  x  6 u.
© Dekora





315119
16 cm ·  x  6 u.
© Dekora



315118
16 cm ·  x  6 u.
© Dekora



315120
16 cm ·  x  6 u.
© Dekora



COMUNIÓN

Holy Communion · Communion · Comunhão · Comunione

RESINA · RESIN · RÉSINE · RESINA



315125

16 cm ·  x  6 u.

© Dekora



315122

16 cm ·  x  6 u.

© Dekora



315123

16 cm ·  x  6 u.

© Dekora





COMUNIÓN



Holy Communion · Communion · Comunhão · Comunione

RESINA · RESIN · RÉSINE · RESINA





315110
16 cm ·  x  6 u.
© Dekora





315115
16 cm ·  x  6 u.
© Dekora



315105
15 cm ·  x  6 u.
© Dekora



315104
15 cm ·  x  6 u.
© Dekora





COMUNIÓN



Holy Communion · Communion · Comunhão · Comunione

RESINA · RESIN · RÉSINE · RESINA





315111
16 cm ·  x  6 u.
© Dekora





315112
16 cm ·  x  6 u.
© Dekora



315113
16 cm ·  x  6 u.
© Dekora



315114
16 cm ·  x  6 u.
© Dekora



COMUNIÓN

Holy Communion · Communion · Comunhão · Comunione

RESINA · RESIN · RÉSINE · RESINA



315099

15 cm ·  x  6 u.

© Dekora



315098

15 cm ·  x  6 u.

© Dekora



315109

13 cm ·  x  6 u.

© Dekora



315107

13 cm ·  x  6 u.

© Dekora



COMUNIÓN

Holy Communion · Communion · Comunhão · Comunione

RESINA · RESIN · RÉSINE · RESINA





315082
12 cm ·  6 u.
© Dekora





315081
12 cm ·  6 u.
© Dekora





315108
13 cm ·  x  6 u.
© Dekora





315106
13 cm ·  x  6 u.
© Dekora



315100
13 cm ·  x  6 u.
© Dekora



315101
13 cm ·  x  6 u.
© Dekora



COMUNIÓN

Holy Communion · Communion · Comunhão · Comunione

RESINA · RESIN · RÉSINE · RESINA



315096

13 cm ·  6 u.

© Dekora



315095

13 cm ·  6 u.

© Dekora



315007

13 cm ·  6 u.

© Dekora



315063

15 cm ·  x  6 u.

© Dekora



COMUNIÓN

Holy Communion · Communion · Comunhão · Comunione

METAL



315054

METAL

16 cm ·  4 u.

© Dekora



315055

METAL

16 cm ·  4 u.

© Dekora



COMUNIÓN

Holy Communion · Communion · Comunhão · Comunione

CLAY



315048
8 cm · 📦 6 u.
© Dekora



315049
8 cm · 📦 6 u.
© Dekora



308002
8 cm · 📦 x 6
© Dekora



308003
8 cm · 📦 x 6
© Dekora



305155
RESINA - Resin
19,5 cm · 📦 2 u.
© Dekora



315041
RESINA - Resin
11 cm · 📦 6 u.
© Dekora



354109
CAKE TOPPER PLÁSTICO
Plastic - Plastique
*Oro efecto espejo · Gold mirror effect
16,5 x 9,9 cm · 📦 x 6



COMUNIÓN

Holy Communion · Communion · Comunhão · Comunione

AZÚCAR · SUGAR · SUCRE · AÇUCAR · ZUCCHERO

AZÚCAR 2D

Sugar - Sucre - Açúcar

211000

10 - 5,5 cm ·  12 u.



205108

6 X 2,5 cm ·  48 u.



210125

3,5 cm ·  70 u



210127

5 / 6 / 7 cm

 12 u.



deKora



UTILLAJE

Tools · Outillage · Utensílios · Utensili



UTILLAJE

Tools · Outillage · Utensílios · Utensili

UTENSILIOS PARA EL DÍA A DÍA

Everyday utensils - Utensiles du quotidien - Utensílios para o dia a dia

Utensili per tutti i giorni



MANGA PASTELERA "SILVER"

Piping bag "Silver" - Poche à douille "Silver"

Saco pasteleiro "Silver" - Tasca da pasticciera "SILVER"

505088	25 cm	6 u.
505089	28 cm	6 u.
505090	34 cm	6 u.
505091	40 cm	6 u.
505093	50 cm	6 u.
505094	55 cm	6 u.
505095	60 cm	6 u.
505096	65 cm	6 u.
505097	70 cm	6 u.
505098	75 cm	6 u.

Efecto anti microbios, reduce el crecimiento de la bacteria y el mal olor (incluso después de lavarlas).



Anti-microbe effect, reduces the growth of the bacteria and the bad smell (even after washing them).



Effet anti-microbes, réduit l'augmentation bactérienne et les mauvaises odeurs (y compris après lavage).



Efeito antimicrobiano, reduz o crescimento da bactéria e o mau odor (mesmo depois de lavar).



Effetto antimicrobico, contrasta la diffusione di batteri e cattivi odori (anche dopo il lavaggio).



Fabricado con múltiples recubrimientos de plástico. Los tamaños desde 34 hasta 75cm tienen la punta reforzada, con costura y colgador. Garantía de THERMO.

MANGAS ESTÁNDAR ALGODÓN

Standard piping bags. Cotton - Poches à douille standar en coton

Sacos pasteleiros standar algodão - Tasche standard in cotone

505001	34 cm	6 u.
505002	40 cm	6 u.
505003	46 cm	6 u.
505004	50 cm	6 u.
505005	55 cm	6 u.
505006	60 cm	6 u.
505007	65 cm	6 u.
505008	70 cm	6 u.
505009	75 cm	6 u.

UK Made multiple plastic coatings. Sizes from 34 to 75 cm With reinforced tip. With seams and hanger. With the THERMO guarantee. **FR** Fabrication à base de multiples revêtements en plastique. Les dimensions allant de 34 à 75 cm ont une extrémité renforcée, avec une couture et un crochet. Garantie THERMO. **PT** Fabricado com múltiplos recubrimientos de plástico. Os tamanhos entre 34 cm e 75cm têm a ponta reforçada, com costura e pega. Garantia THERMO. **IT** Prodotto realizzato con differenti rivestimenti in plastica. I formati dalle dimensioni fra i 34 e i 75 cm sono dotati di punta rinforzata con cucitura e staffa per appendere. Garanzia THERMO.



MANGAS NYLON

Standard piping bags. Nylon - Poches à douille standar en nylon
Saco pasteleiro standar nylon - Tasche in nylon



505079	25 cm	6 u.
505080	34 cm	6 u.
505013	40 cm	6 u.
505023	46 cm	6 u.
505036	50 cm	6 u.
505037	55 cm	6 u.
505038	60 cm	6 u.
505078	75 cm	6 u.



MANGAS PASTELERAS DESECHABLES

Disposable piping bags - Poches à douille "One day" - Mangas confeiteiras descartáveis "one day" - Tasche da pasticciere usa e getta "one day"

VENTAJAS: Transparente, higiénico, punta cerrada, adaptable a boquillas.

ADVANTAGES: Transparent, hygienic, closed tip, adaptable to nozzles. **AVANTAGES:** Transparent, hygiénique, bout fermé, adaptable aux douilles. **VANTAGEN:** Transparente, higiénico, ponta fechada, adaptável aos bicos. **VANTAGGI:** trasparente, igienico, punta chiusa, adattabile ai beccucci

505105 40 cm · 90 μ 100 u.

505106 55 cm · 90 μ 100 u.

505107 65 cm · 90 μ 100 u.

Alta presión

High pressure - Haute pression - Alta pressão - Alta pressione



COLGADOR MANGAS Y BOQUILLAS

Hanger for piping bags and nozzles
Patère pochés à douille et tuyaux
Cabide sacos pasteleiros e bicos
Staffa per appendere tasche e beccucci

535244
0,5 x 0,5 cm · Peso / Weight: 1,3 Kg 1 u.



505081
MANGAS PASTELERAS DESECHABLES

Disposable piping bags
Poches à douille jetables
Mangas confeiteiras descartáveis
Tasche da pasticciere usa e getta
30 cm · 75 μ · 26 mangas







MANGAS DESECHABLES KEE SEAL ULTRA

Kee seal ultra disposable piping bags - Poches à douille jetables Kee Seal Ultra - Sacos pasteiros descartáveis Kee Seal Ultra - Tasche da pasticciere usa e getta Kee Seal Ultra

505025	53 cm	72 µ	 100 u.
505026	63 cm	72 µ	 80 u.
505065	73 cm	72 µ	 50 u.



ANTIDESLIZANTE / NON SLIP / ANTIDÉRAPANT / ANTI-DESLIZANTE / ANTISCIVOLO
MATERIAL RUGOSO / ROUGH MATERIAL / MATIÈRE RUGUEUSE
 / MATERIAL RUGOSO / MATERIALE RUGOSO

CARACTERÍSTICAS: Interior estéril. Superficie exterior Ultra antideslizante para un agarre excelente. Nuevas soldaduras dobles irrompibles en cada manga para extrema resistencia y seguridad. Si la presión ejercida es demasiado extrema, una burbuja alerta al usuario. Cumple con las directivas de la UE para plásticos en contacto con alimentos. Producto de alta calidad fabricado en la UE horneable hasta 110°C, puede calentarse en el microondas y puede congelarse -30°C. • **CERTIFICADO KOSHER**

 **FEATURES:** Sterile inner side. Ultra non-slip outside surface for an excellent grip. New unbreakable double welded seams on each piping bag for extreme security and resistance. If the pressure exerted is too extreme a bubble will alert its user. It complies with the directives of the E.U. for plastics in contact with food. High quality product made in the E.U. Suitable for oven (up to 110°C). Suitable for microwave. Suitable for freezing. (down to -30°C) • **KOSHER CERTIFIED.**  **Intérieur stérile.** Surface extérieure ultra-antidérapante pour une prise optimale. Nouvelles doubles soudures incassables sur chaque manche pour une résistance et une sécurité à toute épreuve. Si la pression exercée est trop forte, une bulle avertit l'utilisateur. Produit conforme aux normes UE s'appliquant aux plastiques entrant en contact avec des aliments. Produit de grande qualité fabriqué en UE, allant au four (jusqu'à 110°C). Il peut être réchauffé au micro-ondes et il peut être congelé jusqu'à -30°C. • **CERTIFIÉ CASHER.**  **Interior estéril.** Superficie exterior ultra anti-deslizante para excelente aderência. Novas soldas duplas inquebráveis em cada saco para maior resistência e segurança. Caso a pressão exercida seja demasiado forte, uma bolha irá alertar o utilizador. Em conformidade com as normas da UE para plásticos em contacto com alimentos. Produto de elevada qualidade fabricado na UE, pode ir ao forno até 110°C, pode ser aquecido no micro-ondas e pode ser congelado a -30°C • **CERTIFICADO KOSHER.**  **CARATTERISTICHE:** Interno sterile. Superficie esterna con effetto ultra-antiscivolo per una presa ottimale. Nuove saldature doppie anti rottura su ciascuna tasca, per il massimo della resistenza e della sicurezza. Quando la pressione esercitata diventa eccessiva, una bolla avverte l'utente. Il prodotto soddisfa i requisiti delle direttive UE sui prodotti in plastica in contatto con gli alimenti. Prodotto di prima qualità, realizzato in UE, può essere riscaldato in forno fino a 110°, in microonde e può essere congelato -30°. • **CERTIFICATO KOSHER**



UTILLAJE

Tools · Outillage · Utensílios · Utensili



BOQUILLA INOXIDABLE INYECTORA

Injector nozzle. Stainless -
Tuyau inoxydable injecteur
Bico inoxidável injector
Beccuccio di iniezione
inossidabile

535084

Ø 0,4 x 9,5 cm · 5 u.



ADAPTADOR PORTABOQUILLAS MEDIANO

Piping bag coupler medium
Adaptateur pour douilles moyen
Adaptador porta-bicos médio -
Adattatore porta beccuccio medio

510082

Ø 2,5 - 3,1 cm · 2 u.



ADAPTADOR PORTABOQUILLAS PEQUEÑO

Piping bag coupler small
Adaptateur pour douilles petit
Adaptador porta-bicos pequeno
Adattatore porta beccuccio piccolo

510081

Ø 1,8 cm · 1 u.



BOQUILLAS LISA INOX.

Piping bag tip round stainless steel - Douille unie en
acier inoxydable - Bicos liso inox. - Beccucci lisci inox.

510083	Ø 0,3 cm	2 u.
510084	Ø 0,5 cm	2 u.
510085	Ø 0,7 cm	2 u.
510086	Ø 0,9 cm	2 u.
510087	Ø 1,1 cm	2 u.
510088	Ø 1,3 cm	2 u.
510089	Ø 1,5 cm	2 u.
510090	Ø 1,8 cm	2 u.



BOQUILLAS ESTRIADAS INOX.

Piping bag tip drop flower stainless steel - Douille
cannelée en acier inoxydable - Bicos estriados inox.

510091	Ø 0,35 cm	2 u.
510092	Ø 0,5 cm	2 u.
510093	Ø 0,7 cm	2 u.
510094	Ø 0,9 cm	2 u.
510095	Ø 1,1 cm	2 u.
510096	Ø 1,3 cm	2 u.
510097	Ø 1,8 cm	2 u.



X6

BOQUILLAS LISA INOX

Smooth nozzles stainless.
Douilles lisses inox.
Bicos liso inox.
Beccucci lisci inox

510140

Ø 0,4/0,6/0,8/1/1,3/1,5 cm 6 u.
Juego 6 boquillas / nozzles set



X6

BOQUILLAS ESTRIADAS 8 DIENTES INOX.

Grooved nozzles 8 stainless grips.
Douilles strié 8 dents inox.
Bicos estriados 8 dentes inox.
Beccucci rigati a 8 denti inox

510143

Ø 0,4/0,6/0,8/1/1,3/1,5 cm 6 u.
Juego 6 boquillas / nozzles set



BOQUILLAS SAINT HONORE INOX

Saint Honore nozzles stainless.
Douilles Saint Honore inox.
Bicos Saint Honore inox.
Beccucci Saint Honore inox

510001

Ø 1,3 x 2 cm TOP: Ø 2,5 cm
📦 5 u.



BOQUILLAS SAINT HONORE INOX

Saint Honore nozzles stainless.
Douilles Saint Honore inox.
Bicos Saint Honore inox.
Beccucci Saint Honore inox

510002

Ø 1,2 x 1,6 cm TOP: Ø 2,5 cm
📦 5 u.



527282

Ø 3,2 x 5,7 cm TOP: Ø 2,2 cm
📦 1 u.



X1

527277

Ø 5,5 x 6 cm TOP: Ø 3,1 cm
📦 1 u.



X1

527278

Ø 5,5 x 6 cm TOP: Ø 3,1 cm
📦 1 u.



527283

Ø 3,2 x 5,7 cm TOP: Ø 2,2 cm
📦 1 u.



527279

Ø 3,2 x 6 cm TOP: Ø 2,2 cm
📦 1 u.



527280

Ø 3,2 x 5,7 cm TOP: Ø 2,2 cm
📦 1 u.



527281

Ø 3,2 x 5,7 cm TOP: Ø 2,2 cm
📦 1 u.



UTILLAJE

Tools · Outillage · Utensílios · Utensili

BOQUILLAS RUSAS

Russian piping sets - Douilles russes - Bicos rusos - Beccuccio russo



527296
Ø 2,7 x 4 cm
8 u.

KIT DE BOQUILLAS SURTIDAS ACERO INOX.

Stainless Steel piping tips box
Kit douilles assorties acier inoxydable
Kit de bicos de aço inoxidável sortido
Kit di beccucci assortiti in acciaio inossidabile



527276
Ø 3,7 x 4,2 cm
12 u.

KIT DE BOQUILLAS SURTIDAS ACERO INOX.

Stainless Steel piping tips box
Kit douilles assorties acier inoxydable
Kit de bicos de aço inoxidável sortido
Kit di beccucci assortiti in acciaio inossidabile



Nº 1 Ø 2,3 cm · 1 u.



Nº 2 Ø 2,5 cm · 1 u.



Nº 3 Ø 2,3 cm · 1 u.



Nº 4 Ø 2,3 cm · 1 u.



Nº 5 Ø 2,5 cm · 1 u.



Nº 6 Ø 2,5 cm · 1 u.



Nº 7 Ø 2,5 cm · 1 u.



Nº 8 Ø 2,5 cm · 1 u.



Nº 9 Ø 2,5 cm · 1 u.



Nº 10 Ø 2,5 cm · 1 u.



Nº 11 Ø 2,5 cm · 1 u.



Nº 12 Ø 2,5 cm · 1 u.



○○○○○
○○○○○
Ø 2,8 cm

PORTA BOQUILLAS 535316

Piping tips display
Porte douilles
Porta bicos
Porta beccuccio

535316

Hasta 30 boquillas
Up to 30 piping tips
Jusqu'à 30 douilles
Até 30 bicos
Fino a 30 beccucci
Ø 2,8 cm



BOQUILLA RIZADA PLÁSTICO

Curled plastic nozzle - Tuyau frisé plastique
Bico ondeado plástico - Beccuccio arricciato in plastica

510019	Ø 0,3 cm	boquilla nº3	6 u.
510020	Ø 0,5 cm	boquilla nº5	6 u.
510021	Ø 0,7 cm	boquilla nº7	6 u.
510022	Ø 0,9 cm	boquilla nº9	6 u.
510023	Ø 1,1 cm	boquilla nº11	6 u.
510024	Ø 1,3 cm	boquilla nº13	6 u.

510200 Ø 0,3/0,5/0,7/0,9/1,1/1,3 cm
 6 u. · Juego 6 boquillas / nozzles set



BOQUILLA LISA PLÁSTICO

Smooth plastic nozzle - Tuyau en plastique
Bico liso plástico - Beccuccio liscio in plastica

510009	Ø 0,5 cm	boquilla nº3	6 u.
510010	Ø 0,7 cm	boquilla nº5	6 u.
510011	Ø 0,9 cm	boquilla nº7	6 u.
510012	Ø 1,1 cm	boquilla nº9	6 u.
510013	Ø 1,3 cm	boquilla nº11	6 u.
510014	Ø 1,5 cm	boquilla nº13	6 u.

510201 Ø 0,5/0,7/0,9/1,1/1,3/1,5 cm
 6 u. · Juego 6 boquillas / nozzles set



BOQUILLAS DE PLÁSTICO SURTIDAS

Assortment of plastic nozzles - Tuyaux en plastique assortis
Bicos de plástico sortidos - Beccucci assortiti in plastica

510138 - A

12 u.

510139 - B

12 u.



BOQUILLAS DE PLÁSTICO SURTIDAS + ADAPTADOR ESPECIALES PARA DECORACIÓN

Assortment of plastic nozzles + special adaptors for decoration - Tuyau en plastique assortis + adaptateurs spéciaux pour décorer - Bicos de plástico sortidos + adaptador especial para decoração - Beccucci assortiti in plastica + adattatori speciali per la decorazione

510136

24 u.



UTILLAJE

Tools · Outillage · Utensílios · Utensili



RODILLO DE PLÁSTICO

Plastic rolling pin - Rouleau en plastique
Rolo de plástico - Rullo in plastica

535194

Rodillo / rolling pin: Ø 7 x 40 cm

Largo total / Total length: 62 cm · 1 u.



RODILLO ESPECIAL MADERA

Special wooden rolling pin - Rouleau spécial en bois
Rolo especial madeira

535410

Rodillo / rolling pin: Ø 8 x 50 cm

Largo total / Total length: 80 cm · 1 u.



RODILLOS PUNTEADORES PLÁSTICO

Plastic pointed rolling pins - Rouleaux pontillieurs en plastique - Rolos ponteadores plástico - Rulli puntatori in plastica

535171

Ancho rodillo / Width of the rolling pin: 11,5 cm · 1 u.



CORTADORES PLÁSTICO CIRCULAR DE REJILLA

Round plastic cutters with grid - Coupeur en plastique rond avec grillage - Cortadores plástico circular de grade cutter plastica circolare a griglia

535306

Ancho rodillo / Width of the rolling pin: 10 cm · 1 u.



RODILLO FIJO MADERA

Wooden rolling pin - Rouleau en bois - Rolo de madeira - Rullo fisso legno

535000

Rodillo / rolling pin: Ø 8 x 50 cm

Largo total / Total length: 70 cm · 1 u.

PISTOLA DE AZÚCAR

Sugar gun - Pistolette du sucre - Pistola de açúcar - Rullo speciale legno
Pistola da zucchero

535197

1 u.

CON 20 DISCOS INTERCAMBIABLES

With 20 interchangeable discs
Avec 20 disques interchangeables
Com 20 discos intercambiáveis
Con 20 dischi intercambiabili

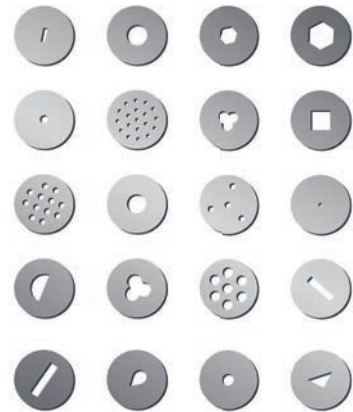

L



CORTADOR INOX.

Stainless cutter - Coupeur inox.
Cortador inox. - Cutter inox

535352

L: 23 cm x Ø 10 cm · 1 u.





CORTA PASTAS CIRCULAR EXOGLASS®

Round cookie cutter - Coupe-pâtes rond
Corta pastas circular - Affetta torte circolare

535139 - B

535138 - A

Ø 3 a 10 cm · 9 u

Ø 2 a 10 cm · 9 u.



CORTAPASTAS CORAZÓN ACERO INOX.

Pastry cutter heart-shaped - Coupe-pâte cœur - Cortador massa coração
Affetta torte cuore inox

535235

Ø 5 / 6,5 / 8 cm · 3 u.



CORTADOR CROISSANTS ACERO INOX.

Stainless croissant cutter - Coupeur croissant inox. - Cortador croissants inox. Cutter croissant inox

535117

20 x 12 cm · 1 u.



MINI ECLAIR

Cookie cutter inox. Coupe-pâtes inox. Cortapastas inox. Affetta torte inox.

543236

1,8 x 6 cm · 1 u.



ECLAIR

Cookie cutter inox. Coupe-pâtes inox. Cortapastas inox. Affetta torte inox.

543235

2,5 x 12,5 cm · 1 u.



CORTAPASTAS REDONDO INOX.

Round cookie cutter inox. Coupe-pâtes rond inox. Cortapastas redondo inox. Affetta torte rotondo inox.

541027

Ø 3 - 14 cm · 12 u.

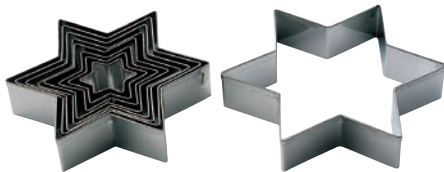

SURTIDO CORTAPASTAS ESTRELLAS ACERO INOX.

Christmas cookie cutter set
Set décopoirs Noël
Set corta massas Natal
Set formine Natale

543017

Ø 3,7/5,1/6,6/8,2/9,6/11/12,5/13,7/15 cm

x 9 u.



SURTIDO CORTAPASTAS ESTRELLAS ACERO INOX.

Christmas cookie cutter set
Set décopoirs Noël- Set corta massas Natal - Set formine Natale

543233

Ø 6/8,5/11/13,5/16 cm x H: 4 cm

x 5 u.

PARTIDOR TORTAS

Cake cutter - Fendeur de galettes
Partidor tortas Porzionatore torte

535273

Ø 26,5 cm · 12 / 16 piezas. · 1 u.





UTILLAJE

Tools · Outillage · Utensílios · Utensili



CORTADOR EXTENSIBLE 5 RUEDAS INOX.

Extendible cutter, 5 wheels. Stainless - Coupeur extensible 5 roues inox. - Cortador extensível 5 rodas inox. - Cutter estensibile 5 ruote inox.

535148

1 u. · Ancho máximo / Maximum width: 50,5 cm



CORTADOR EXTENSIBLE 7 RUEDAS INOX.

Extendible cutter 7 wheels. Stainless - Coupeur extensible 7 roues inox. - Cortador extensível 7 rodas inox - Cutter estensibile 7 ruote inox.

535149

1 u. · Ancho máximo / Maximum width: 50,5 cm



CUCHILLA PARA CORTAR PAN CON 25 CUCHILLAS

Bread slashing lame with 25 blade - Lame droite pour pain avec 25 lames - Faca de pão direitas com 25 facas Taglierino per pane a 25 lame

535240

14,5 x 1,4 cm · Plástico + inox. alimentario
PVC + inox food grade · 1 u.



CUCHILLA PARA CORTAR PAN

Blade for cutting bread - Lame pour couper le pain
Folha para cortar pão - Taglierino per pane

535251

15 cm · Cuchilla / Blade: 4 cm · 1 u.



PALAS DE MEDICIÓN DE PLÁSTICO

Plastic - Plastique - Plástico - Palette con misurino in plastica

535025

500 ml

6 u.

535026

1.000 ml

6 u.

535029

1.250 ml

6 u.



PALAS DE MEDICIÓN DE PLÁSTICO (PP)

Plastic - Plastique - Plástico - Palette con misurino in plastica

535321

250 ml

6 u.



ESTAMPADOR DE REJILLA

Cookie stamp crisscross pattern - Grille d'impression
Estampador de grelha - Stampo per decorare a griglia

535271

Ø 3 cm · 1 u.



CEPILLO HARINERO

Flour brush - Brosse farinière - Escova farinha
Spazzolino per farina
Blanco - White - Blanc - Branco - Bianco

535064

30 cm · 1 u.



BOL DE PLÁSTICO ROJO

Material: plástico
 Color: rojo
 Con asa
 Apilable
 Apto para uso corto en microondas

535032	Ø 17,5 cm · H: 8 cm	1 u.
535033	Ø 23 cm · H: 10,5 cm	1 u.
535034	Ø 27,5 cm · H: 12 cm	1 u.

RED PLASTIC BOWLS

Material: PP
 Colour: red
 With convenient handle
 Stackable
 Suited for short-term in microwaves

BOL PLASTIQUE ROUGE

Matière: Plastique
 Coloris: rouge
 Avec anses
 Empilable
 Convient pour une courte utilisation au micro-ondes

TACA PLÁSTICO VERMELHA

Material: Plástico
 Cor: vermelho
 Com pegas
 Empilhável
 Apto para uma curta utilização em micro-ondas

CIOTOLA DI PLASTICA ROSSA

Materiale: Plastica
 Colore: rosso
 Con manici
 Impilabile
 Adatto per un uso breve ni microonde



BOL SEMIREDONDO PLÁSTICO

Half round plastic bowl - Bol semi-rond en plastique - Tigela semi-redonda plástico - Ciotola semi rotonda in plastica

Altura / H: 8 cm	Ø 17,5 cm
Altura / H: 10,5 cm	Ø 23 cm
Altura / H: 11,5 cm	Ø 27,5 cm
Altura / H: 15 cm	Ø 32 cm
Altura / H: 16 cm	Ø 36 cm
Altura / H: 18 cm	Ø 40 cm

536025

6 u.



BOL PLÁSTICO CON PICO Y ASA

Plastic bowl with spout and handle - Cul de poule plastique - Ciotola in plastica con beccuccio e maniglia

526000

23,5 x H: 14 cm · 4.000 ml · 1 u.



BOL DE PLÁSTICO

Plastic bowl - Bol en plastique - Tigela plástico - Ciotola in plastica

(A)	526140	Ø 17,5 cm · H: 8 cm · 1.000 ml	1 u.
(B)	526141	Ø 27,5 cm · H: 12 cm · 4.500 ml	1 u.
(C)	526142	Ø 36 cm · H: 16 cm · 9.000 ml	1 u.



BOL DE METAL

Metal Bowl - Bol en métal - Tigela metal - Ciotola in metallo

535266 Ø 24 cm · H: 10 cm · 2.500 ml 1 u.



UTILLAJE

Tools · Outillage · Utensílios · Utensili



COLADOR TAMIZ EXOGLASS

MALLA A. INOX.

Exoglass sieve strainer
Tamis exoglass maille inox
Colino setaccio maglia
in acciaio inox

535218

Ø 20 cm - 0.7 mm PASO - MESH

1 u.



CEDAZO PLÁSTICO AZÚCAR GLAS

Plastic strainer. Icing sugar
Tamis en plastique sucre glace
Peneira plástico açúcar glass
Setaccio plastico zucchero a velo

535036

Ø 18,5 x 10,5 cm

Paso / abertura: 0,5 mm

Malla / rede: 0,2 mm · 1 u.



CEDAZO PLÁSTICO

Plastic strainer - Tamis en plastique
Peneira de plástico
Setaccio plastico

535040

Ø 30,5 x 11 cm

Paso / abertura: 0,85 mm

Malla / rede: 0,24 mm

1 u.



JARRA DE MEDICIÓN DE PLÁSTICO

Meter Jar - Carafe mesurante - Jarra medidora
Caraffa con misurino in plastica

535003

1 litro.

6 u.

535004

2 litros.

6 u.

535005

3 litros.

6 u.

535006

5 litros.

6 u.



JARRA MEDIDORA DE CRISTAL

Glass measuring cup
Pichet gradué en verre
Jarro medição
Caraffa con misurino in vetro

535055

1 litro · 1 u.



BOTELLA DE PLÁSTICO PARA BAÑAR BIZCOCHO CON ESCALA GRADUADA

Plastic bottle to dip sponge cake with graduated
scale - Bouteille en plastique pour bagner gâteaux
avec échelle graduée - Garrafa de plástico para
banha com escala graduada - Borraccia in plastica
per inzuppare il biscotto con scala graduata

ERGONÓMICA

Ergonomic - Ergonomique
Ergonómico - Ergonomica

535198

10,5 x 6 x H: 27,5 cm · 1 litro.

1 u.



BIBERÓN BOCA ANCHA

Dispenser wide nozzle
Dosificateur bouche large
Dosificadores bocal largo
Biberon bocca larga

535330

236 ml

1 u.

535350

354 ml

1 u.

535351

708 ml

1 u.



RASPADOR FLEXIBLE ACERO INOX.

Scraper Stainless steel
Grattoir flexible acier inox.
Rasgador flexível aço inox.
Raschiatore flessibile acciaio inox.

541197

17,5 x 10 cm · 1 u.



RASPADOR FLEXIBLE ACERO INOX.

Scraper Stainless steel
Grattoir flexible acier inox.
Rasgador flexível aço inox.
Raschiatore flessibile acciaio inox.

541308

12 x 11,5 cm · 1 u.



RASPADOR RÍGIDO ACERO INOX.

Stiff Scraper Stainless - Grattoir rigide acier inox
Rasgador rígido aço inox. - Raschiatore rigido acciaio inox.

541311

19 x 14,5 cm · 1 u.



RASPADOR RÍGIDO INOX.

Stiff scraper Stainless
Grattoir rigide inox.
Rasgador rígido inox.
Raschiatore rigido acciaio inox.

541215

11 x 10,5 cm · 1 u.



ESPÁTULA PROFESIONAL CHOCOLATE

Professional spatula Chocolate
Spatule professionnelle chocolat
Espátula professional Chocolate
Spatola professionale cioccolato

541309

15 x 6 cm · 1 u.



RASPADOR LISO PLÁSTICO

Dough scraper plastic - Grattoir lisse en plastique
Rasgador liso plástico - Raschiatore liscio plastico

541321

11,3 x 7,5 cm · 1 u.



RASPADOR LISO PLÁSTICO RESISTENTE HASTA 125°

Smooth plastic scraper. Resistant up to 125°
Grattoir lisse en plastique résistant jusqu'à 125°
Rasgador liso plástico resistente até 125° -
Raschiatore liscio plastico resistente fino a 125°

541314

14,8 x 9,9 cm · 1 u.



RASQUETA ACERO INOX.

Scraper Stainless steel
Grattoir acier inox.
Rasgador aço inox.
Affilatore piccolo acciaio inox.

541312

24,5 x 15 cm

1 u.



RASPADOR A. INOX CON AGARRE REDONDEADO

Stainless steel dough cutter with round handle
Corne de pâtissier inox avec grip rond
Raschiatore inox. con impugnatura arrotondato

541001

13 x 11 cm · 1 u.



UTILLAJE

Tools · Outillage · Utensílios · Utensili



BATIDORES MANGO PP

Whisk - Fouet - Batedor - Frullatore manico PP

535515	25 cm	1 u.
535010	30 cm	1 u.
535746	35 cm	1 u.
535747	40 cm	1 u.
535745	45 cm	1 u.
535748	50 cm	1 u.

BATIDORES MANGO FIBRA

Whisk - Fouet - Batedor - Frullatore manico fibra

535044	25 cm.	1 u.
535045	30 cm.	1 u.
535046	35 cm.	1 u.
535047	40 cm.	1 u.
535048	45 cm.	1 u.
535049	50 cm.	1 u.



BATIDORES MANGO ACERO INOX.

Handle. Stainless steel - Fouets manche en acier inox. - Batedores cabo de aço inox. Frullatori manico acciaio inox.

535199	25 cm	1 u.
535226	35 cm	1 u.
535219	40 cm	1 u.
535224	45 cm	1 u.
535225	60 cm	1 u.

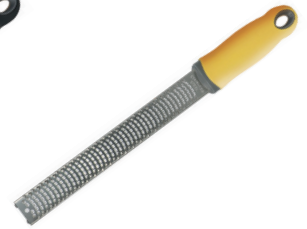
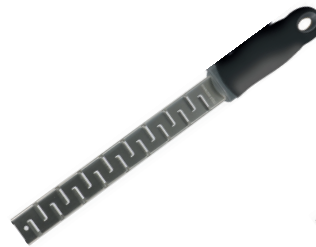

RALLADOR GRANDE ESPECIAL

Grater - Râpe - Ralador Grattugia rende speciale **626002**

20 x 2,5 cm · 1 u.

RALLADOR FINO ESPECIAL

Grater - Râpe - Ralador - Grattugia fino speciale **626000**

20 x 2,5 cm · 1 u.



BROCHA CERDA NATURAL

Brush. Natural bristle - Brosse soie naturelle Broxa cerda natural - Spazzola setole naturali

535058	Cerda / Bristle: 4 x 4 cm	1 u.
535059	Cerda / Bristle: 4 x 6 cm	1 u.
535060	Cerda / Bristle: 4 x 7,5 cm	1 u.
535742	Cerda / Bristle: 4 x 10 cm	1 u.



BROCHA CERDA NATURAL

Brush. Natural bristle - Brosse soie naturelle Broxa cerda natural - Spazzola setole naturali

535294	Cerda / Bristle: 6 x 4 cm	1 u.
535315	Cerda / Bristle: 6 x 5 cm	1 u.
535156	Cerda / Bristle: 6 x 7,5 cm	1 u.

UTILLAJE

Tools · Outillage · Utensílios · Utensili



ESPÁTULAS EXOGLASS®

Spatulas - Spatule - Espátula - Spatole

541017	25 cm	1 u.
541020	30 cm	1 u.
541021	35 cm	1 u.
541024	50 cm	1 u.



BROCHA DE SILICONA 220°

Silicone brush 220° - Pinceau silicone 220°
Broxa silicone 220° - Spazzola silicone 220°

535077	(1) Cerda / Bristle: 6 cm	1 u.
535539	(1) Cerda / Bristle: 7,5 cm	1 u.



ESPÁTULA SILICONA

Silicone spatula - Spatule silicone
Espátula resistente - Spatola silicone

541113	25 cm	1 u.
---------------	-------	------

Mango de fibra reforzada
Incluye agujero para colgar



ESPÁTULA SILICONA SUPER RESISTENTE 230°

Silicone spatula super resistant 230° - Spatule silicone super résistant 230° - Espátula resistente até 230° - Spatola silicone super resistente fino a 230°

541245	(1): 25 cm	1 u.
541007	(1): 35 cm	1 u.
541246	(1): 45 cm	1 u.

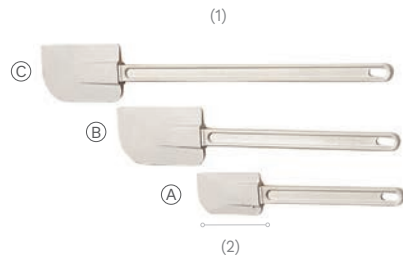

ESPÁTULAS PLÁSTICO - GOMA

Plastic-rubber spatulas - Spatules en plastique
Gomme Espátulas plástico - goma - Spatole plastica-gomma

541028 A	(1): 25 cm (2): 8 x 5 cm	1 u.
541029 B	(1): 35 cm (2): 11,5 x 7 cm	1 u.
541030 C	(1): 45 cm (2): 11,5 x 7 cm	1 u.



UTILLAJE

Tools · Outillage · Utensílios · Utensili



ESPÁTULA ACERO INOX. PLANA

Palette knife. Stainless - Spatule acier inox
Espátula aço inox. - Spatola acciaio inox. piana

541052

(1): 34 cm
(2): 21 cm
Ancho / Widht:
3,4 cm

1 u.

541053

(1): 39 cm
(2): 26 cm
Ancho / Widht:
3,4 cm

1 u.

541054

(1): 43 cm
(2): 31 cm
Ancho / Widht:
3,4 cm

1 u.

541055

(1): 49 cm
(2): 36 cm
Ancho / Widht:
3,4 cm

1 u.



ESPÁTULA FLEXIBLE A. INOX

Flexibel stainless spatula
Spatule inox - Spatola flessibile inox.

541026 (1): 24 cm · (2): 12 cm

1 u.

541019 (1): 35 cm · (2): 24 cm

1 u.



ESPÁTULA EXTRALARGA A. INOX

Extra long stainless spatula
Spatule extra longue inox - Spatola extralarge inox.

541010 (1): 30,5 cm · (2): 4,5 cm

1 u.

541011 (1): 35,5 cm · (2): 5 cm

1 u.



ESPÁTULA CODO ESPECIAL PIZZA/PAN A. INOX

Pizza/pan flippers offset stainless spatula
Spatule coudée spécial pizza/pain INOX
Spatola gomito speciale per pizza/paine inox.

541048

19 x 7,5 cm · 1 u.



ESPÁTULA ACERO INOX. CODO

Offset spatula - Spatule acier inox coudée

Espátula aço inox. Cotovelo - Spatola acciaio inox. Gomito

541106	(1) 10 x (2) 3,4 cm	1 u.
541228	(1) 15 x (2) 3,4 cm	1 u.
541008	(1) 20 x (2) 3,4 cm	1 u.
541230	(1) 25 x (2) 3,4 cm	1 u.

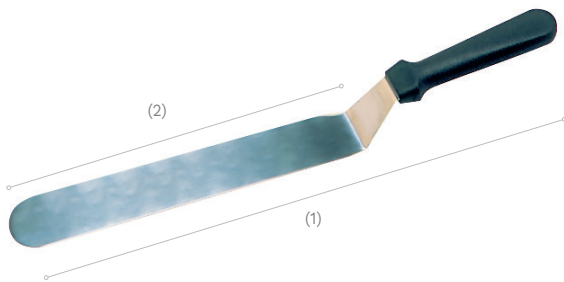

ESPÁTULA ACERO INOX. CODO

Palette knife. Elbow. Stainless

Spatule acier inox coudé

Espátula aço inox. Cotovelo

Spatola acciaio inox. Gomito

541194

(1): 31,5 cm

(2): 15,5 cm

Ancho / Width: 3,2 cm

1 u.



ESPÁTULA CODO ANGULAR A. INOX

Angular offset stainless spatula - Spatule coudée angulaire inox - Spatola gomito angolare inox.

541012

9 cm · ancho hoja 2 cm

1 u.

ESPÁTULA CODO A. INOX.

Offset stainless spatula
Spatule coudée inox
Spatola gomito angolare inox.

541013

9,5 cm · ancho hoja 2 cm

1 u.

ESPÁTULA CODO HOJA ONDULADA A. INOX

Angular blade offset stainless spatula
Spatule coudée ondulée inox
Spatola gomito ondulata inox.

541014

9 cm · 1 u.



UTILLAJE

Tools · Outillage · Utensílios · Utensili



CUCHILLO ANGULAR SIERRA

Angular knife serrated wave - Couteau angulaire denté - Coltello angolare seghettato

541015

(1): 18 cm · (2): 3 cm

1 u.



CUCHILLO CON PUNTA DOBLE HOJA SIERRA/LISA

Pointed knife double sided
Couteau avec point double lame
Coltello con doppia punta seghettato/liscio

541016

(1): 17 cm · (2): 4,8 cm

1 u.



CUCHILLO LISO PARA PASTERERÍA

Cake and pastry plain knife - Couteau lame lisse pâtisserie - Faca lisa para pasteleria - Coltello liscio per pasticceria

541003

(1): 31 cm · (2): 3,4 cm

1 u.



CUCHILLO SIERRA PARA PASTERERÍA

Cake and pastry saw knife - Couteau denté pour pâtisserie - Faca serra para pasteleria
Coltello seghettato per pasticceria

541009

(1): 31 cm · (2): 4,5 cm

1 u.



CUCHILLO DE DOBLE SIERRA INOX.

Baker's knife double sided - Couted double dentelé inox. - Faca de dupla serra inox. - Coltello a doppia seghettatura inox

541340

(1): 36 cm (2): 3,4 cm · 1 u.



CUCHILLO DE SIERRA DIENTES DE OLA INOX.

Bread knife - Couteau à pain - Faca para pão
Coltello con lama seghettata a onde inox.

541098

(1): 24 cm (2): 2,6 cm · 1 u.



CUCHILLO DE SIERRA INOX.

Stainless serrated knife - Couteau dentelé inox.
Faca de serra inox. - Coltello chiuso inox.

541079

(1): 44,5 cm · (2): 31 cm (3): 3,4 cm · 1 u.

541085

(1): 49,5 cm (2): 36 cm (3): 3,4 cm · 1 u.



CUCHILLO LISO

Cake knife - Couteau lisse - Faca lisa - Coltello liscio

541105

(1): 24 cm

1 u.



CUCHILLO DE SIERRA

Bread scoring knife - Couteau dentelé - Faca de serra - Coltello chiuso

541190

(1): 8,7 cm (2): 1,5 cm · 1 u.



CUCHILLO PUNTILLA

Paring knife - Couteau pointu - Faca de ponta
Coltello punta

541108

(1): 9 cm · 1 u.

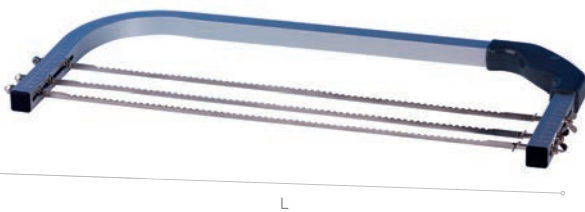

CUCHILLO SERRADO PARA TARTAS

Serrated knife for cakes - Couteau dentelé pour des tapes - Faca serrada para tapas - Coltello chiuso per torte

541350

46 cm · Peso / Weight: 250 g · 1 u.

Acero inox. · Con 3 hojas de sierra · Ajustable desde 1 a 9 cm

With 3 saw leaves. Adjustable from 1 to 9 cm

Avec 3 feuilles de scie. Ajustable de 1 à 9 cm

Com 3 folhas de serra. Ajustável de 1 a 9cm

Con sega a 3 fogli. Regolabile da 1 a 9 cm



NIVELADOR ACERO INOX.

Stainless steel leveler - Nivelador de aço inoxidável
Niveleur en acier inoxydable - Livellatore in acciaio inox

535530

50 x 18 x h: 6 cm. · 1 u.

Ancho max. de espacamiento: 40 cm. / Grosor: 0,1 a 1,8 cm.

Max width spread: 40 cm. / Thickness: 0.1 to 1.8 cm

Largeur maximale largeur : 40 cm. / Épaisseur : 0,1 à 1,8 cm.

Largura máxima propagação: 40 cm. / Espessura: 0,1 a 1,8 cm.

Larghezza massima diffusione: 40 cm. / Spessore: da 0,1 a 1,8 cm.

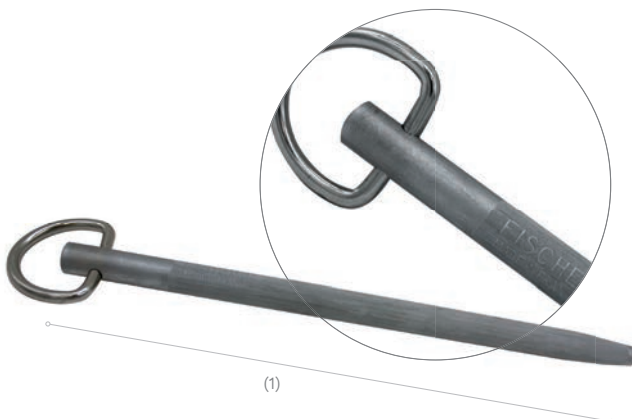

AFILADOR CHAIRA A. INOX.

Steel professional knife sharpening
Aiguiseur de couteau en acier inoxydable
Apontador aço inox faca
Affilatore acciaio inox.

541184

(1): 19 cm · Ø 1 cm

1 u.



UTILLAJE

Tools · Outillage · Utensílios · Utensili

HERRAMIENTAS PARA TRABAJAR FONDANT

Fondant tools - Outils pour travail fondant - Ferramentas para trabalhar fondant



Utensile "ruota" per modellare il fondant



CORTAPASTAS VOLANTE "FORMA RECTA"

Straight shape frill cutter
Emporte pièce volant forme droite
Corta-massa babado forma de reto
Taglia pasta volante "formato dritto"

543192

15 x 6 cm ·  1 

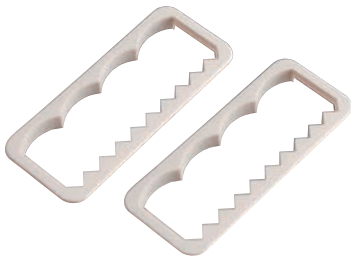
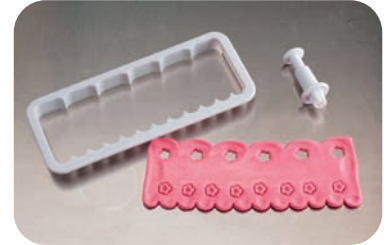

CORTAPASTAS "VOLANTE"
Garret frill cutter - Emporte
pièce volant - Corta-massa
babado - Taglia pasta volante

543191

15 x 6 cm ·  1 



CORTAPASTAS VOLANTE "BORDADO INGLÉS"

Broderie anglaise shape frill cutter
Emporte pièce "broderie anglaise" -
Corta-massa babado "bordado inglés"

Taglia pasta volante "Ricamo inglese"

543146



15 x 6 cm ·  1 



CORTAPASTAS "1, 3 Y 5 PÉTALOS"

1, 3 and 5 Petals cutter
Emporte pièce fleur de 1, 3 et 5
pétales - Corta-massa 1, 3 e 5
pétalos - Taglia pasta da 1, 3 e 5
petali

543190

Ø 3,2 cm ·  1 





CORTAPASTAS EXPULSOR ESTRELLA

Star shape plunger cutter
Emporte pièce éjecteur étoile
Corta-massa ejetor estrela
Taglia pasta espulsore a stella

543160

0,7 - 1 - 1,3 cm · 1 1



CORTAPASTAS EXPULSOR DIAMANTE

Diamond shape plunger cutter
Emporte pièce éjecteur diamant
Corta-massa ejetor diamante
Taglia pasta espulsore a diamante

543164

0,7 - 1 - 1,4 - 2,5 cm · 1 1



CORTAPASTAS EXPULSOR OVALADA

Oval shape plunger cutter
Emporte pièce éjecteur ovale
Corta-massa ejetor óvalo
Taglia pasta espulsore ovale

543165

0,7 - 1 - 1,4 - 2,5 cm · 1 1



CORTAPASTAS CÁLIZ

Calyx flower cutter
Emporte pièce calice
Corta-massa cálice
Taglia pasta calice

543188

2,3 - 3,3 - 4 cm

1 1





UTILLAJE

Tools · Outillage · Utensílios · Utensili



ALISADOR PLÁSTICO PARA FONDANT

Plastic fondant ally
Allié fondant plastique
Fondant de plástico aliado
Alleato di fondente di plastica

535015

 1 u.





RODILLO PARA FONDANT

Fondant rolling pin - Rouleau à pâte à fondant
Rolo de fondant - Rullo in fondant

535011

Rodillo / rolling pin: Ø 4,5 x 50 cm

1 u.



RODILLO PARA FONDANT

Fondant rolling pin - Rouleau à pâte à fondant
Rolo de fondant - Rullo in fondant

535014

Rodillo / rolling pin: Ø 2,5 x 23 cm

1 u.



**SET 8 ANILLOS PARA
RODILLO FONDANT**

Set 8 rings assort. for roller - Jet de 8 anneaux assortis. pour rouleau
Set 8 anelli assortiti. per rullo - Set 8 anéis assort. para rolo

535016

Rodillo / rolling pin: Ø 2,5 x 23 cm

8 u.

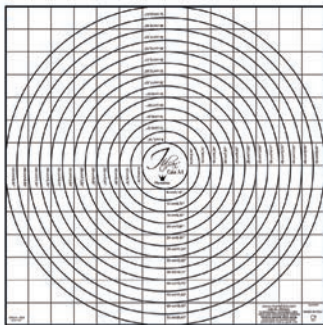

**TAPETE DE PLÁSTICO ANTIDESLIZANTE
CON CÍRCULOS CONCÉNTRICOS**

Non-slip plastic mat with concentric circles
Tapis en plastique antidérapant avec cercles concentriques
Tapete plástico antiderrapante com círculos concéntricos
Tappetino in plastica antiscivolo a cerchi concentrici

535008

60 x 58 cm

1 u.



**UTENSILIO “RUEDA” PARA
MODELAR FONDANT**

Modeling fondant wheeler tool
Ustensile forme “roue” pour moulage
fondant - Esteca roda - Utensile “ruota”
per modellare il fondant

535193

15,5 cm · 1





UTILLAJE

Tools · Outillage · Utensílios · Utensili



Temp. MAX
60 °C

GUANTES CARAMELO

Caramel gloves - Gants caramel - Luvas Caramelo
Guanti caramello

535186

1 par.



Temp. MAX
220 °C

GUANTES CORTOS DE ALGODÓN PARA HORNO

Short cotton gloves for oven - Gants courts en coton
pour le four - Luvas curtos de algodão para forno
Guanti da forno corti in cotone

535180

26 x 14,5 cm · 1 par.



Temp. MAX
220 °C

AGARRADERA DE ALGODÓN PARA HORNO

Cotton grip for oven - Poignée en coton pour le four
Asa de algodão para forno - Presina da forno in cotone

535182

29 x 24 cm · 1 u.



Temp. MAX
220 °C

AGARRADERA PARA HORNO CON BANDA ELÁSTICA

Cotton even cloth elastic band - Coton four tissu
élastique band - Luvas largos de algodão para forno
elástico band - Presina da forno con banda elastica

535227

29 x 24 cm · 1 u.

250 - 280 °C



180 - 200 °C



MANOPLAS ANTICALOR PIEL

Mitts against heat. Leather - Moufles antichaleur peau
Luvas anticolor pele - Manopole contro il calore pelle

535174 - A	Anilla larga / Long ring	40 cm	1 par
535175 - B	Reforzada larga / Long. Reinforced	40 cm	1 par
535176 - C	Reforzada mediana Middle. Reinforced	36 cm	1 par
535177 - D	Reforzada corta Short. Reinforced	33 cm	1 par



Temp. MAX
220 °C

GUANTES LARGOS DE ALGODÓN PARA HORNO

Long cotton gloves for oven - Gants
longs en coton pour le four - Luvas
largos de algodão para forno - Guanti
da forno lunghi in cotone

535181

40 x 15 cm · 1 par.



GUANTES EN CUERO FORRADO RESISTENTES AL CALOR EXTREMO

Lined leather gloves in extreme heat resistant
Gants courts en coton pour le four - Luvas de couro forrado em extreme resistente ao calor - Guanti in cuoio imbottito resistenti alle temperature estreme

535557

45 x 14 cm · 1 par.

VENTAJAS DEL PRODUCTO: Hasta aprox. 250°C
No aptos para lavar a máquina.

ADVANTAGES OF THE PRODUCT: Up to approx. 250°C
Non suitable to be machine washed.

AVANTAGES DU PRODUIT: Jusqu'à aprox. 250°C
Non apte pour laver à machine.

VANTAGENS DO PRODUTO: ATÉ aprox. 250°C
Não aptos para lavar a máquina.

VANTAGGI DEL PRODOTTO: Resistente fino a 250°C
circa. Non idonei al lavaggio in lavatrice



GUANTES DE ALGODÓN RESISTENTES A ALTAS TEMPERATURAS

Cotton gloves resistant to high temperatures
Gants en coton résistant aux hautes températures
Luvas de algodão resistentes a altas temperaturas
Guanti in cotone resistenti alle alte temperature

535347

32 x 15 cm · 1 par.

VENTAJAS DEL PRODUCTO: Hasta aprox. 250°C

ADVANTAGES OF THE PRODUCT: Up to approx. 250°C

AVANTAGES DU PRODUIT: Jusqu'à aprox. 250°C

VANTAGENS DO PRODUTO: ATÉ aprox. 250°C

VANTAGGI DEL PRODOTTO: Resistente fino a 250°C



FUNDAS DE PLÁSTICO PARA CARROS

Plastic covers for carts - Étui en plastique pour charriots - Estojos de plástico para carroças
Fodere in plastica per carri

506001

12 µ · 60 x 40

75 x 25 x 180 cm

200 u.

506007

12 µ · GN 2/1

74 x 35,5 x 180 cm

200 u.



FUNDAS PARA PLACA

Sheet covers - Étuis pour plaque - Capas para placa
Fodere per placca

506002

40 µ · 80 x 55 cm · 100 u.

HOJAS PLÁSTICO TRANSPARENTE

Transparent plastic sheets
Lames en plastique transparent
Folhas plástico transparente
Fogli di plastica trasparente

506003

110 µ · 60 x 40 cm

100 u.





UTILLAJE

Tools · Outillage · Utensílios · Utensili

PASO A PASO

Step by step - Pas à pas - Passo a passo - Passo dropo passo

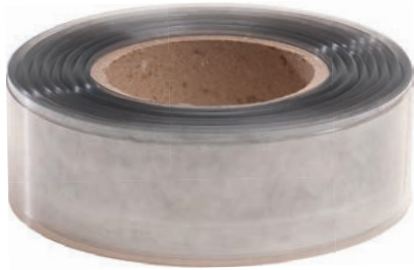

NEW

ROLLOS DE ACETATO

Acetate rolls - Rouleau en acétate
Rolos de acetato - Rotoli di acetato

535329

75 µ · 4 cm, x 305 mts. ·  1 u.



NEW

LÁMINAS DE ACETATO

Acetate sheets - Lames en acétate
Lâminas de acetato - Lamine di acetato

535331





75 µ · 60 x 40 cm

 50 u.



ROLLOS DE ACETATO

Acetate rolls - Rouleau en acétate - Rolos de acetato - Rotoli di acetato

535233	200 µ.	3 cm x 50 mts.	 1 u.
535234	200 µ.	3,5 cm x 50 mts.	 1 u.
535236	200 µ.	4 cm x 50 mts.	 1 u.
535238	200 µ.	4,5 cm x 50 mts.	 1 u.
535237	200 µ.	5 cm x 50 mts.	 1 u.

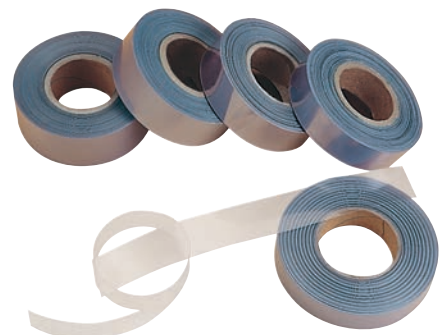



TERMOMETRO INFRARROJO
-50 ~ 420 ° C

Infrared thermometer
Thermomètre infrarouge
Termómetro infravermelho
Termometro a infrarossi

537000
6,6 x 5,3 x 1,2 cm · 1 u.



TERMÓMETRO INFRARROJOS

Infrared thermometer -
Thermomètre infrarouge
Termómetro infravermelho
Termometro a infrarossi

537004
Temperatura / Temperature: -35° a
365°C · 1 u.

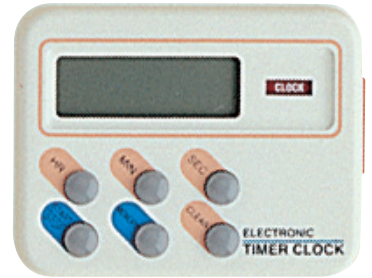

RELOJ DIGITAL
CON ALARMA 24 H.

Electronic timer clock with alarm 24h
Horloge digital avec alarme 24h
Relógio digital com alarme
Orologio digitale con timer

537008
6,6 x 5,3 x 1,2 cm · 1 u.



TERMÓMETRO DIGITAL MULTIFUNCIÓN -50° ~ +150°

Digital thermometer with inox probe -50° ~ +150°
Thermomètre numérique avec sonde inox -50° ~ +150°
Termómetro digital com sonda de aço inox -50° ~ +150°
Termometro digitale con sonda in acciaio inox -50° ~ +150°

537013
Temperatura / Temperature: -50° a 150° C.
Mide temperatura en °C / Measures temperature in °C
Effettua le misurazioni in °C

1 u.



TERMÓMETRO ELECTRÓNICO CON Sonda

Electronic thermometer with probe - Thermomètre
électronique avec sonde - Termómetro eletrônico
com sonda - Termometro digitale con sonda

537009
Temperatura / Temperature: -50° a 300° C
Waterproof alarma · 1 u.



TERMÓMETRO CAMELO MALLA METAL
ALCOHOL

Caramel thermometer. Metal mesh. Alcohol.
Thermomètre caramel maille alcool.
Termómetro caramelo malha metal álcool.
Termometro per caramello maglia metallo alcool

537017
Temperatura / Temperature: 80° a 220°C · 1 u.



TERMÓMETRO DIGITAL MULTIFUNCIÓN -40° ~ +200°

Digital thermometer with inox probe -40° ~ +200°
Thermomètre numérique avec sonde inox -40° ~ +200°
Termómetro digital com sonda de aço inox -40° ~ +200°
Termometro digitale con sonda in acciaio inox -40° ~ +200°

537016
Temperatura / Temperature: -40° a 200° C. · 1 u.



UTILLAJE

Tools · Outillage · Utensílios · Utensili



PALA ELÉCTRICA DE QUEMAR INOX. 220 V.

Electric burner. Stainless 220 V.
Palle électrique de brûler inox.
220 V. - Pala eléctrica de quemar
inox. 220V. - Paletta elettrica per
scottare inox. 220V

535252

1.500 W. · 7 x 23 cm · Peso /

Weight: 1,2 Kg · 1 u.

Bajo pedido / On request / Sur demande / A
pedido / Su richiesta

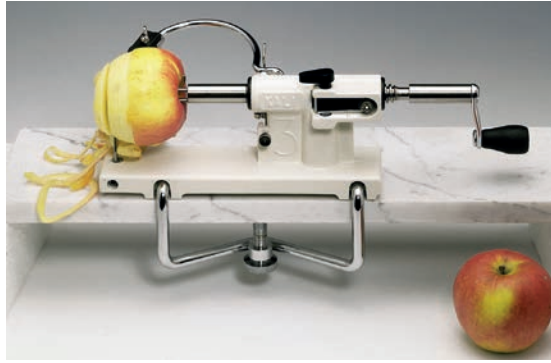

PELAMANZANAS "KALI" 3 USOS, CON POSIBILIDAD DE DESMONTAR

"Kali" apple peeler 3 uses. Detachable - Pele-pommes de terre
"kali" 3 uses, avec possibilité d'être démonter - Pela maçãs "kali"
3 usos, com possibilidade de desmontar - Sbucciamele a 2 utilizzi
con possibilità di smontare

535231

10 x 34 x H: 11 cm · Peso / Weight: 2,5 Kg · 1 u.



pH-METRO 535307

16,2 cm · 1 u.

VENTAJAS DEL PRODUCTO

Escala pH: 0-14 - Margen de medición +/-1 °C - Temperatura de
resolución: 0,5 °C - Resolución: 0,1 pH - Incluye 4 pilas LR44

ADVANTAGES OF THE PRODUCT

- pH scale: 0-14 - Measuring range +/-1GRADO - Resolution
temperature: 0,5 °C - Resolution: 0,1 pH - Includes 4 batteries
LR44

AVANTAGES DU PRODUIT

- Échelle de pH: 0-14 - Plage de mesure +/-1 °C - Température
de résolution: 0,5 °C - Résolution: 0,1 pH - Comprend 4 piles
LR44

VANTAGENS DO PRODUTO

- Escala pH: 0-14 - Intervalo de medição +/-1 °C - Temperatura
de resolução: 0,5 °C - Resolução: 0,1 pH - Inclui 4 pilhas LR44

VANTAGGI DEL PRODOTTO

- Escala pH: 0-14 - Margine di misurazione +/-1 °C - Temperatura
di risoluzione 0,5 °C - Risoluzione: 0,1 pH - Comprende 4
pile LR44



SOPLETE PROFESIONAL

Professional blowtorch - Chalumeau professionnel
Maçarico profissional - Cannello professionale

535155

15,5 x 7,5 x H: 3,5 cm · Peso / Weight: 250 g · 1 u.

VENTAJAS DEL PRODUCTO

Seguro, ligero - Fácil de recargar - Portátil (sin cables -
Llama regulable - Sistema de seguridad - Temperatura
máxima: 1.300°

ADVANTAGES OF THE PRODUCT

- Safe, light - Easy to reload - Portable (no cables) - Ad-
justable flame - Security system - Maximum temperature:
1300°

AVANTAGES DU PRODUIT

- Sûr, léger - Facile à recharger - Portable (sans câbles)
- Flamme réglable - Système de sécurité - Température
maximale: 1.300°

VANTAGENS DO PRODUTO

- Seguro, leve - Fácil de recarregar - Portátil (sem cabos)
- Chama ajustável - Sistema de segurança - Temperatura
máxima: 1.300°

VANTAGGI DEL PRODOTTO

- Sicuro, leggero - Ricarica facile - Portatile (non ha cavi)
- Fiamma regolabile - Sistema di sicurezza - Temperatura
massima: 1.300°



CARTUCHOS PARA SIFÓN

Cartridges for siphon
Cartouches pour siphon
Cartuchos para sifão
Cartucce per sifone

535357

1 u.



Las nuevas cargas profesionales mejoran sustancialmente el rendimiento de las cargas antiguas.

El mayor rendimiento de las nuevas cargas profesionales, hace que de la misma cantidad de líquido que introducimos en el sifón, obtengamos hasta un +20% de volumen de producto montado en comparación con las cargas antiguas, con el consiguiente ahorro en producto.

The new professional loads substantially improve the performance of the old loads.

The greater performance of the new professional loads means that from the same quantity of liquid that we insert into the siphon, we obtain up to +20% volume of assembled product in comparison with the old loads, with the consequent savings in product.

Les nouvelles recharges professionnelles améliorent de manière substantielle le rendement des anciennes recharges.

Le rendement supérieur des nouvelles recharges professionnelles permet que la même quantité de liquide introduit dans le siphon donne jusqu'à 20% de volume de produit réalisé supplémentaire, comparé aux anciennes recharges, ce qui permet d'utiliser moins de produit.

As novas recargas profissionais melhoram substancialmente o rendimento das recargas antigas.

O maior rendimento das novas recargas profissionais, faz com que com a mesma quantidade de líquido introduzida no sifão, seja obtido até cerca de 20% de volume de produto acabado em comparação com as recargas antigas, com a consequente poupança no produto.

Le nuove ricariche professionali migliorano sensibilmente le prestazioni rispetto alle precedenti.

La maggiore resa delle nuove ricariche professionali permette di introdurre la stessa quantità di liquido nel sifone ottenendo fino al 20% in più di volume del prodotto montato rispetto alle ricariche precedenti, con un notevole risparmio sul prodotto antigas, con a conseguente poupança no produto.



SIFÓN PARA CREMA INOX

Siphon for cream. Stainless - Siphon pour crème inox. - Sifão para creme inox - Sifone per crema inox

535355

1 L. · 1 u.

	Cargas profesionales /Professional loads	Cargas antiguas /Old loads
Contenido en gas /Gas content	8,4 g (+12%)	7,5 g
Rendimiento /Performance	Hasta +20%	



BALANZA DIGITAL CAP. 15 Kg / 1g

Digital scale - Balance Numérique - Balanço digital
Bilancia digitale

Pantalla LED de alta definición - High-definition LED Display
Affichage LED haute Définition - Display LED de alta definição
Schermo LED ad alta definizione.

Potencia: 4x 1.5V pilas AA (incluido)/Power: 4x 1.5V AA batteries (included) -
Puissance: 4x piles AA 1.5V (inclus)/Potência: 4 pilhas AA de 1,5V (incluído)

535297

23 x 25 x 16 cm · 1 u.

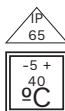

BALANZA ELECTRÓNICA 6 K

Electronic weighing scale - Balance électronique - Bilancia elettronica
535105

23 x 25 x 16 cm · 1 u.

Bajo pedido / On request / Sur demande / A pedido / Su richiesta



UTILLAJE

Tools · Outillage · Utensílios · Utensili



PORTAPRECIOS CORONA PLÁSTICO

Plastic crown price tag holder
Porte-prix en plastique couronne
Portapreços plástico coroa
Espositore porta prezzi corona plastica

540197

7 x 4 cm ·  15 u.



PORTAPRECIOS PLÁSTICO

Plastic price tag holders
Porte-prix en plastique
Porta-preços plástico
Espositore porta prezzi plastica

540198

6 x 8 cm ·  25 u.



PORTAPRECIOS CUADRADOS

Plastic squares price tag holder
Porte-prix en plastique carré
Portapreços plástico square
Espositori porta prezzi quadrati

540295

6 x 8 cm ·  40 u.



PORTAPRECIOS PLÁSTICO

Plastic price tag holders
Porte-prix en plastique
Porta-preços plástico
Espositore porta prezzi plastica

540201

6 x 5 cm ·  50 u.



PALITOS DE PIRULETA

Lollipop sticks - Bâtonnets pour
sucettes - Palitos de chupas
Stecchi per lecca-lecca

515434

 x 12  x 24 u.





PIPETAS CUENTA GOTAS

Perfectas para dar un toque de sabor, salsa o licor a tus elaboraciones.



To add a touch of a particular flavour to a bottle of sauce, liqueur, vinaigrette, coulis, etc.



Pour ajouter une touche d'une saveur particulière à une bouteille de sauce, liqueur, vinaigrette, coulis, etc.



Para um toque de um sabor específico a um frasco de molho, licor, vinagrete, puré de frutas, etc.



Pipette contagocce. Perfette per aggiungere un tocco di sapore, salsa o liquore alle tue preparazioni.



Ref. 535313

1,5 ml / 6,3 x 0,25 cm

📦 500 u.



Ref. 535314

4 ml / 15 x 0,25 cm

📦 500 u.



PLATO PEQUEÑO FORMA CUCHARA

Small tray spoon shape - Petit plateau forme cuillère - Colher pequena - Piatto piccolo a forma di cucchiaio

515045

10,5 x 5 x H: 3 cm

Capacidad / Capacity: 11 ml · 📦 100 u.



UTILLAJE

Tools · Outillage · Utensílios · Utensili



VASO PLÁSTICO TRANSPARENTE JAPAN

Transparent little plastic Japan glass
Petit verre plastique transparent
Japan - Copinho de plástico
transparente Japan - Bicchierino
plastica trasparente Japan

515471

Ø 5 x H: 5,4 cm · 87 ml · 100 u.



VASITO PLÁSTICO TRANSPARENTE VELA

Transparent little plastic candle glass
Petit verre plastique transparent bougie
Copinho de plástico transparente vela
Bicchierino plastica trasparente candela

515007

7,3 x 8,1 x H: 6,7 cm · 140 ml · 100 u.



VASO PLÁSTICO TRANSPARENTE SQUARE

Transparent little plastic Square glass
Petit verre plastique transparent
Square - Copinho de plástico
transparente Square - Bicchierino
plastica trasparente Square

515469

5,5 x 5,5 X H: 8 cm · 175 ml · 100 u.



VASO CUADRADO PLÁSTICO

Square plastic cup - Verre carré en
plastique - Copo quadrado plástico
Bicchiere quadrato plastica

515073

5 x 7 cm · 120 ml · 100 u.



VASO TRIANGULAR PLÁSTICO

Triangular plastic cup
Verre triangulaire en plastique
Copo triangular plástico
Bicchiere triangolare in plastica

515075

Ø 8,5 x 6,5 cm · 175 ml · 100 u.



VASO PLÁSTICO SOFTICE

Cup softice - Verre softice
Bicchiere in plastica

515453

Ø 5,9 x 7 cm · 105 ml.

100 u.



VASO PLÁSTICO CON BASE

Plastic cup with base
Verre en plastique avec base
Copo plástico com base
Bicchiere in plastica con base

515074

Ø 7 x 6,7 cm · 135 ml · 100 u.



Material reciclable al 100% - 100% recyclable material - Matériau 100 % recyclable - Material 100% reciclável - Materiale riciclabile al 100%



**VASITO PLÁSTICO
TRANSPARENTE GREEK**

Transparent little plastic Greek glass
Petit verre plastique transparent
Greek - Copinho de plástico
transparente Greek - Bicchierino
plastica trasparente Greek

515450

7,3 x 6,1 cm · 120 ml · 100 u.



VASO PENTA PLÁSTICO

Plastic Penta glass - Verre Penta
plastique - Copo Penta de plástico
Bicchiere plastic Penta

515468

Ø 7,2 x H: 5,6 cm · 120 ml

100 u.



**VASO PLÁSTICO
TRANSPARENTE WAFFLE**

Transparent little plastic Waffle glass
Petit verre plastique transparent
Waffle - Copinho de plástico
transparente Waffle - Bicchierino
plastica trasparente Waffle

515452

6,4 x 6,2 x H: 5,9 cm · 70 ml · 100 u.



**VASITO PLÁSTICO
TRANSPARENTE WAVE**

Transparent little plastic Wave glass
Petit verre plastique transparent Wave
Copinho de plástico transparente Wave
Bicchierino plastica trasparente Wave

515449

8,5 x 6 x H: 7 cm · 120 ml · 100 u.



**VASO PLÁSTICO TRANSPARENTE
HEART**

Transparent little plastic Heart glass
Petit verre plastique transparent Heart
Copinho de plástico transparente Heart
Bicchierino plastica trasparente Heart

515470

7,3 x 6,4 X H: 5,2 cm · 100 ml · 100 u.



**VASITO PLÁSTICO
TRANSPARENTE VELA**

Transparent little plastic candle glass
Petit verre plastique transparent bougie
Copinho de plástico transparente vela
Bicchierino plastica trasparente candela

515451

6,3 x 6,9 x H: 5,7 cm · 85 ml · 100 u.



**VASO TUBE
TRANSPARENTE PLÁSTICO**

Transparent plastic tube glass
Verre tube transparent plastique
Copo tube transparente de plástico
Bicchiere tube plastica trasparente

515041

Ø 4 x H: 8,5 cm · 80 ml · 100 u.



VASO CLASSIC PLÁSTICO

Classic plastic glass - Verre Classic
plastique - Copo Classic de plástico
Bicchiere Classic plastica

515467

Ø 4,2 x H: 6,5 cm · 65 ml

100 u.





UTILLAJE

Tools · Outillage · Utensílios · Utensili



PINZAS DEL CHEF

Chef's tweezers - Pincettes de chef

Pinças do cozinheiro chefe - Pinze da chef



535300

14,5 x 1 cm



535305

1,5 x 0,7 cm

TUTORIAL RECETA PARA VASITOS

Recipe for cups - Recette de verrines - Receita para copinhos - Tutorial ricetta per bicchierini

Escanea este código QR y sigue los sencillos pasos de este vídeo.

 Scan this QR code and follow the simple steps in this video.

 Scannez ce code QR et suivez les étapes de cette vidéo.

 Digitalize este código QR e siga os passos simples deste vídeo.

 Scansiona il codice QR e segui i semplici passaggi illustrati nel video





**CUBIERTA TRANSPARENTE PARA BANDEJA DE PLÁSTICO 60 x 40 cm
PLÁSTICO RESISTENTE A LA CONGELACIÓN**

Transparent cover for plastic Tray 60 x 40 cm Freeze-resistant plastic - Couverture transparent pour plateau en plastique 60 x 40 cm. Plastique résistant à la congélation - Coberta transparente para bandeja de plástico 60 x 40 cm. Plástico resistente à congelação - Copertura trasparente per vassoio in plastica 60 x 40 cm. Plastica resistente al congelamento

540103

Bandeja + tapa / Tray + cover
60 x 40 x H: 6,2 cm

 1 u.

540218

Solo tapa / Only cover
59 x 36 x H: 6 cm

 1 u.



BANDEJA HORNO ALUMINIO PERFORADA

Baking tray perforated aluminium - Plateaux à four perforé en aluminium - Tabuleiro forno alumínio perfurado - Vassoio forno alluminio perforato

540278

60 x 40 cm

 1 u.

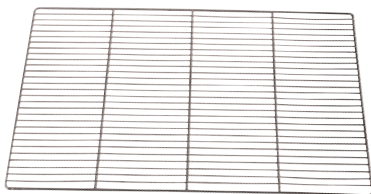

REJILLA CROMADA

Chrome-plated grill - Grillage chromage
Grade cromado

540150

60 x 40 cm ·  1 u.



REJILLA CROMADA CON PIES

Chrome-plated grill with legs - Grillage chromage avec pieds - Grade cromado com pés - Grata cromata con piedini

540235

60 x 40 cm ·  1 u.



UTILLAJE

Tools · Outillage · Utensílios · Utensili

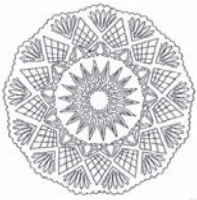

BANDEJA "STELLA"

Tray - Plateau - Bandeja - Vassoio

EXT (A)

540169

Ø 27,5 cm - Color cristal

 94 u.

540336

Ø 36,5 cm - Color cristal

 36 u.

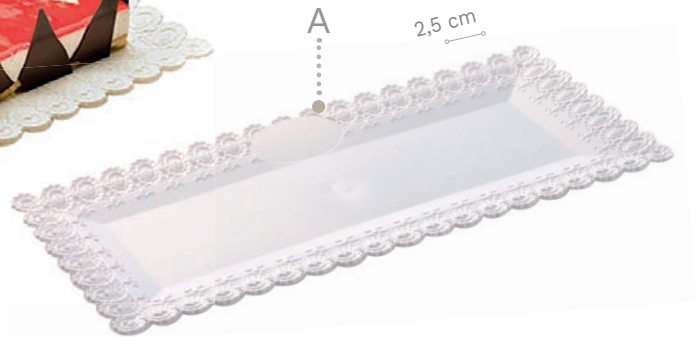

BANDEJA RECTANGULAR BLANCA VECCHIO 30X17 cm

Rectangular tray VECCHIO 30 x 17 cm - Plateau rectangulaire VECCHIO 30 x 17 cm - Vassoio rettangolare bianco 30 x 17 cm

EXT (A)

515461

30 x 17 cm

 94 u.

A EXTERIOR
B INTERIOR

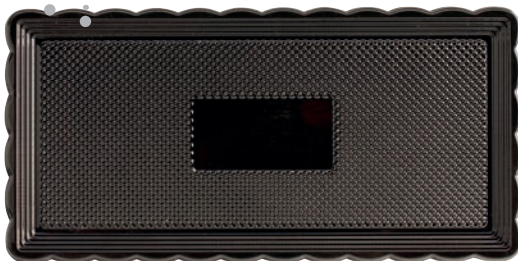

BANDEJA RECTANGULAR

Rectangular tray - Plateau rectangulaire
Bandeja rectangular - Vassoio rettangolare

EXT (A)

INT (B)

515421

30 x 15 cm 17,5 x 12 cm

 150 u.

515422

35 x 15 cm 32 x 12 cm

 150 u.

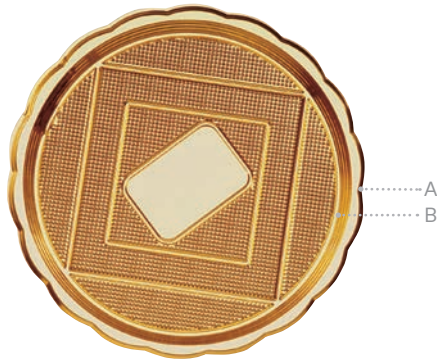

BANDEJA "MEDORO NEW"

Tray - Plateau - Bandeja - Vassoio

EXT (A) INT (B)

540264 Ø 30 cm Ø 26,5 cm 100 u.

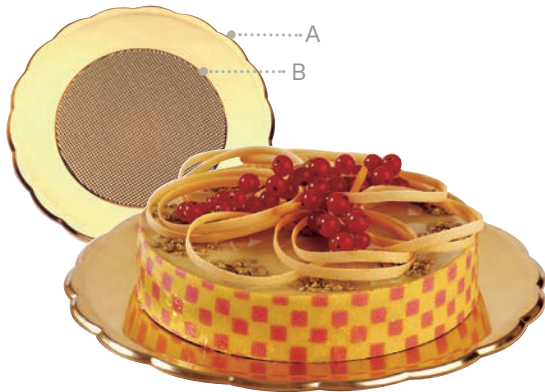

BANDEJA "MEDORO"

Tray - Plateau - Bandeja - Vassoio

EXT (A) INT (B)

540013 Ø 26 cm Ø 26 cm 120 u.

540014 Ø 28 cm Ø 28 cm 100 u.

540015 Ø 30 cm Ø 30 cm 100 u.

540016 Ø 32 cm Ø 32 cm 100 u.

540017 Ø 34 cm Ø 34 cm 60 u.



BANDEJA RECTANGULAR "MEDORO"

Rectangular tray - Plateau rectangulaire

Bandeja rectangular - Vassoio rettangolare

EXT (A) INT (B)

540021 15 x 25 cm 12 x 22,5 cm 150 u.

540022 15 x 30 cm 12 x 27 cm 150 u.

540023 15 x 35 cm 12 x 32,5 cm 100 u.

540024 15 x 40 cm 12 x 37 cm 100 u.

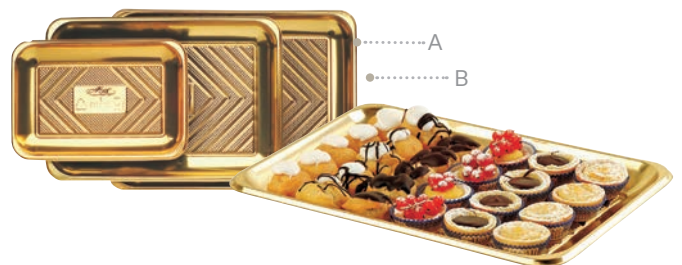

BANDEJA "KADO" DORADA

Golden "Kado" tray - Plateau "Kado" doré

Bandeja "Kado" dourada - Vassoio "Kado" dorato

EXT (A) INT (B)

540253 28,5 x 20,5 cm 22,5 x 14,5 cm 200 u.

540254 32 x 22 cm 25 x 15,5 cm 150 u.

540255 34,5 x 25,5 cm 28 x 18,5 cm 100 u.

540256 37,5 x 28 cm 30,5 x 21 cm 100 u.



UTILLAJE

Tools · Outillage · Utensílios · Utensili



MINI BANDEJA PLÁSTICO NEGRO GOGO CUADRADA 8,5 CM

Mini plastic tray GOGO black square 8,5 cm
Mini plateau en plastique GOGO noir carré 8,5 cm
Mini bandeja de plástico GOGO preto quadrado 8,5 cm
Mini vassoio in plastica nera quadrato 8,5 cm

EXT (A)

515485

9 X 10,5 cm

 400 u.

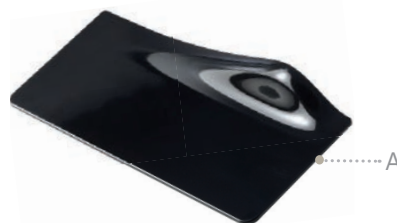

MINI BANDEJA PLÁSTICO NEGRO GOGO RECTANGULAR 8,5 CM

Mini plastic tray GOGO black rectangular 8,5 cm
Mini plateau en plastique GOGO noir rectangulaire 8,5 cm
Mini bandeja de plástico GOGO preto rectangular 8,5 cm
Mini vassoio in plastica GOGO nera rettangolare 8,5 cm

EXT (A)

515486

14 x 5,5 cm

 400 u.



MINI BANDEJA PLÁSTICO NEGRO GOGO REDONDA 8,5 CM

Mini plastic tray GOGO black round 8,5 cm
Mini plateau en plastique GOGO noir rond 8,5 cm
Mini bandeja de plástico GOGO preto redondo 8,5 cm
Mini Vassoio in plastica GOGO nera 8,5 cm

EXT (A)

515484

Ø 8,5 cm

 400 u.

UTILLAJE

Tools · Outillage · Utensílios · Utensili



BANDEJA EFECTO PIEDRA

Stone effect tray - Plateau effet pierre
Bandeja efeito pedra - Vassoio effetto
pietra

540000

11 x 11 cm

 320 u.



BANDEJA EFECTO PIEDRA

Stone effect tray - Plateau effet
pierre - Bandeja efeito pedra
Vassoio effetto pietra

540027

24 x 24 cm

 80 u.



BANDEJA EFECTO PIEDRA

COLOR GRIS - Stone effect tray grey colour - Plateau
effet pierre grise - Bandeja efeito pedra cor gris
Vassoio effetto pietra

540028

30 x 14 cm ·  80 u.



UTILLAJE

Tools · Outillage · Utensílios · Utensili

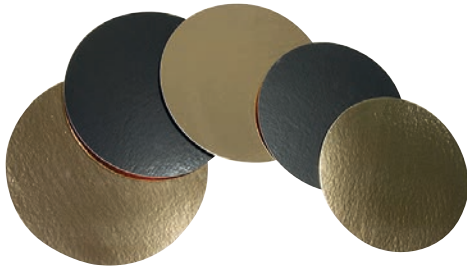

DISCO DE CARTÓN ORO/NEGRO

Cake board gold or black round - Disque en carton or-noir - Disco de cartão dourad/negro
Disco di cartone oro/nero

(A)	540053	Ø 20 cm	100 u.
(B)	540208	Ø 24 cm	100 u.
(C)	540185	Ø 26 cm	100 u.
(D)	540209	Ø 28 cm	100 u.
(E)	540212	Ø 30 cm	100 u.
(F)	540192	Ø 32 cm	100 u.

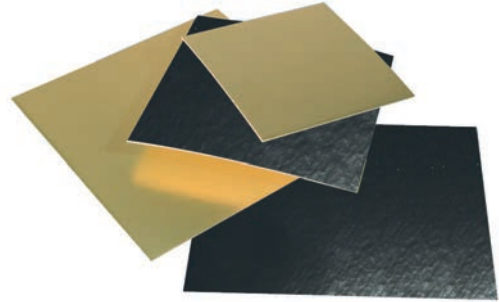

BANDEJA DE CARTÓN ORO/NEGRO

Cardboard tray gold or black rectangle - Plateau en carton or-noir - Bandeja de cartão dourado-negro
Vassoio di cartone oro/nero

(A)	540194	30 x 40 cm	25 u.
(B)	540225	60 x 40 cm	25 u.



PLATO CARTÓN MINI CORAZÓN ORO / NEGRO

Mini heart cardboard plate gold/black - Assiette carton mini-coeur or/noir - Prato cartão mini coração oro/preto - Piatto in cartone mini cuore oro/nero

540090

Ø 8 cm · 200 u.



PLATO CARTÓN MINI CUADRADO ORO / NEGRO

Mini square cardboard plate gold/black - Assiette carton mini-carré or/noir - Prato cartão mini quadrado oro/preto - Piatto in cartone mini quadrato oro/nero

540091

8 x 8 cm · 200 u.



PLATO CARTÓN RECTANGULAR ORO / NEGRO MINI

Cardboard plate gold/black - Assiette en carton or/noir
Prato cartão oro/preto - Piatto di cartone oro/nero mini

540217

9 x 5,5 cm · 300 u.



PLATO REDONDO CARTÓN ORO / NEGRO MINI

Mini round cardboard plate gold/black - Mini assiette ronde en carton or/noir - Mini prato redondo cartão oro/preto - Mini piatto rotondo in cartone oro/nero mini

540213

8 cm · 300 u.



BASES REDONDAS ONDULADAS

Scalloped Cake board - Bases rondes ondulées - Basi rotonde ondulate

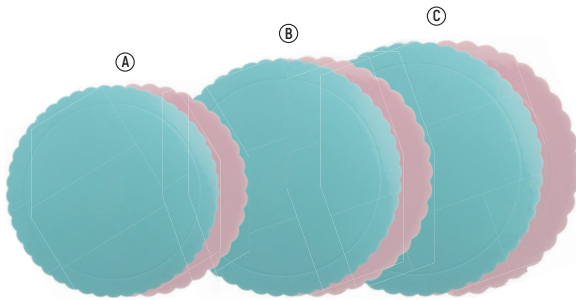

DOBLE CARA

Doble cara - Double face - Duas caras - Doppia faccia

(A)	540296	0,3 Ø 25 cm	1 u.
(B)	540297	0,3 Ø 30 cm	1 u.
(C)	540298	0,3 Ø 35 cm	1 u.

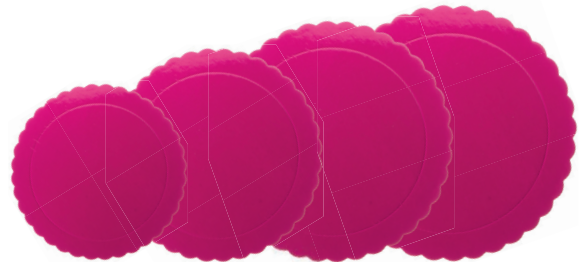
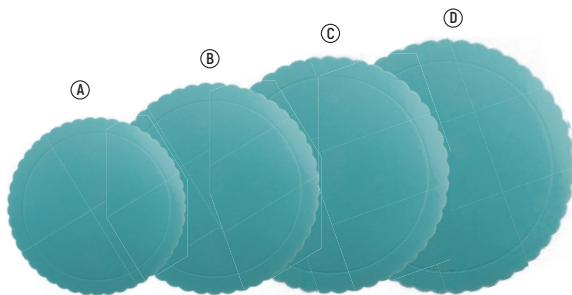

(A)	540237	0,3 x Ø 20 cm	1 u.
(B)	540238	0,3 x Ø 25 cm	1 u.
(C)	540239	0,3 x Ø 30 cm	1 u.
(D)	540280	0,3 x Ø 35 cm	1 u.

(A)	540240	0,3 x Ø 20 cm	1 u.
(B)	540241	0,3 x Ø 25 cm	1 u.
(C)	540242	0,3 x Ø 30 cm	1 u.
(D)	540281	0,3 x Ø 35 cm	1 u.

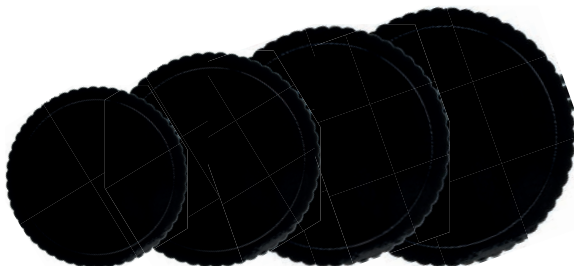

(A)	540243	0,3 x Ø 20 cm	1 u.
(B)	540244	0,3 x Ø 25 cm	1 u.
(C)	540245	0,3 x Ø 30 cm	1 u.
(D)	540279	0,3 x Ø 35 cm	1 u.

(A)	540246	0,3 x Ø 20 cm	1 u.
(B)	540247	0,3 x Ø 25 cm	1 u.
(C)	540249	0,3 x Ø 30 cm	1 u.
(D)	540149	0,3 x Ø 35 cm	1 u.



UTILLAJE

Tools · Outillage · Utensílios · Utensili

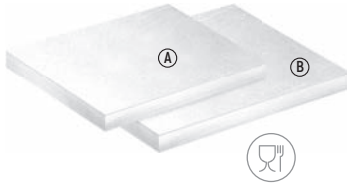

blancas - white - blanc - branco - bianco

NEW

(A) **540360** 25 x 25 cm x H: 1,2 cm

1 u.

NEW

(B) **540361** 30 x 30 cm x H: 1,2 cm

1 u.

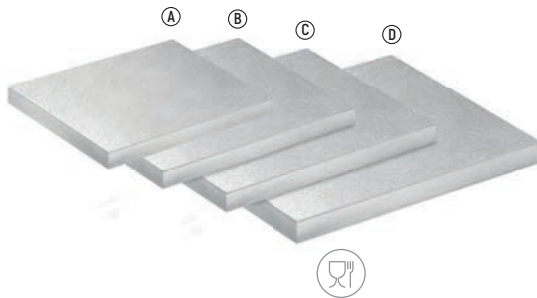

plata - silver - argent - prata - argento

NEW

(A) **540359** 25 x 25 cm x H: 1,2 cm

1 u.

(B) **540270** 30 x 30 cm x H: 1,2 cm

1 u.

(C) **540075** 35,5 x 35,5 cm x H: 1,2 cm

1 u.

(D) **540271** 40 x 40 cm x H: 1,2 cm

1 u.

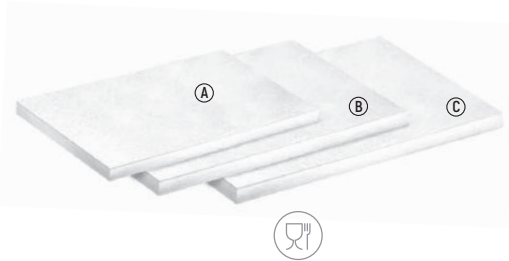

blancas - white - blanc - branco - bianco

NEW

(A) **540365** 20 x 30 cm x H: 1,2 cm

1 u.

NEW

(B) **540367** 35 x 30 cm x H: 1,2 cm

1 u.

NEW

(C) **540370** 30 x 40 cm x H: 1,2 cm

1 u.



plata - silver - argent - prata - argento

NEW

(A) **540364** 20 x 30 cm x H: 1,2 cm

1 u.

(B) **540273** 30 x 25 cm x H: 1,2 cm

1 u.

(C) **540272** 35 x 25 cm x H: 1,2 cm

1 u.

(D) **540277** 35 x 30 cm x H: 1,2 cm

1 u.

NEW

(E) **540371** 30 x 40 cm x H: 1,2 cm

1 u.

UTILLAJE

Tools · Outillage · Utensílios · Utensili



plata - silver - argent - prata - argento



(A) 540358	Ø 20 x H: 1,2 cm	1 u.
(B) 540226	Ø 25 x H: 1,2 cm	1 u.
(C) 540229	Ø 30 x H: 1,2 cm	1 u.
(D) 540236	Ø 35 x H: 1,2 cm	1 u.
(E) 540268	Ø 40 x H: 1,2 cm	1 u.
(F) 540269	Ø 45 x H: 1,2 cm	1 u.

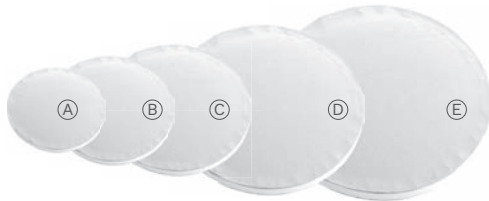

blancas - white - blanc - branco - bianco



(A) 540356	Ø 20 x H: 1,2 cm	1 u.
(B) 540299	Ø 25 x H: 1,2 cm	1 u.
(C) 540304	Ø 30 x H: 1,2 cm	1 u.
(D) 540305	Ø 35 x H: 1,2 cm	1 u.
(E) 540352	Ø 40 x H: 1,2 cm	1 u.



doradas - gold - or - oro

(A) 540306	Ø 25 x H: 1,2 cm	1 u.
(B) 540307	Ø 30 x H: 1,2 cm	1 u.
(C) 540308	Ø 35 x H: 1,2 cm	1 u.
(D) 540353	Ø 40 x H: 1,2 cm	1 u.



negras - black - noir - preto - nero

(A) 540309	Ø 25 x H: 1,2 cm	1 u.
(B) 540310	Ø 30 x H: 1,2 cm	1 u.
(C) 540311	Ø 35 x H: 1,2 cm	1 u.
(D) 540354	Ø 40 x H: 1,2 cm	1 u.



UTILLAJE

Tools · Outillage · Utensílios · Utensili



354124
MICKEY AND FRIENDS
Ø 25 cm · H: 12 cm ·  x 1 u.



354134
AVENGERS
Ø 25 cm · H: 12 cm ·  x 1 u.



POLIESTIRENO (PS)
341154
Ø 30 cm / H: 11 cm



BANDEJA EXPOSICIÓN
Giratoria
Cake Display rotatory
Plateau présentoir pivotant
Bandeja exposição giratório
Vassoio da esposizione girevole
341124
Ø 31,5 cm / H: 8,5 cm ·  1 u.

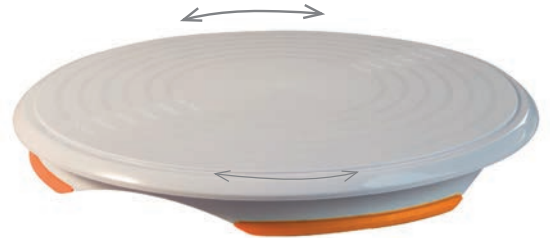

BANDEJA EXPOSICIÓN - GIRATORIA
Cake display stand - ROTARY
Plateau présentoir - PIVOTANT
Bandeja exposição - GIRATÓRIO
Vassoio da esposizione - GIREVOLE
341155
Ø 30,5 X H: 3,2 cm ·  1 u.



GIRATORIO
Rotary - Pivotant - Giratório - Girevole
535217
Ø 32 x 10 cm · Peso / Weight: 600 g ·  1 u.



BANDEJA DE EXPOSICIÓN INCLINABLE GIRATORIA
Cake Display rotatory tilting - Plateau présentoir pivotant avec
inclinasion - Bandeja exposição giratório de inclinação
Vassoio esposizione inclinabile girevole
535230
Ø 23 cm ·  1 u.



CAJAS PARA PASTELERÍA SIN IMPRESIÓN BLANCAS

Pastry boxes without printing (white) - Boîtes à pâtisserie sans impression (blanche) - Caixas para pastelaria sem impressão (brancas) - Scatole per pasticceria senza stampa (bianche)

Cartón de alta resistencia apto para el contacto con alimentos; 100% fibra virgen. Cajas ideales para pastelería, bollería, venta para llevar, catering...

High-strength cardboard suitable for contact with food; 100% virgin fiber. Ideal boxes for pastries, pastries, takeaway sales, catering,...

En carton haute résistance adapté au contact alimentaire ; 100% fibre vierges. Coffrets idéaux pour pâtisseries, viennoiseries, vente à emporter, traiteur,...

Em cartão de alta resistência adequado ao contacto com alimentos; 100% fibra virgem. Caixas ideais para pastelaria, pastelaria, takeaway, catering,...

In cartone ad alta resistenza idoneo al contatto con gli alimenti; 100% fibra vergine. Scatole ideali per pasticceria, pasticceria, vendita da asporto, catering,...



CUADRADA

Square - Carré - Quadrado - Quadrato

(**)



542000	4	23 x 23 x 10 cm (*)	50 u.
542007	4	26 x 26 x 10 cm (*)	50 u.
542008	4	29 x 29 x 10 cm (*)	50 u.
542009	4	32 x 32 x 10 cm (*)	50 u.
542010	4	23 x 23 x 13 cm	50 u.
542011	4	26 x 26 x 13 cm	50 u.
542012	4	32 x 32 x 13 cm	50 u.
542013	6	16 x 16 x 8 cm (*)	50 u.
542014	6	20 x 20 x 8 cm (*)	50 u.
542015	6	22 x 22 x 8 cm (*)	50 u.
542016	6	25 x 25 x 8 cm (*)	50 u.
542017	6	28 x 28 x 8 cm (*)	50 u.



CON ASAS

With handles - Avec poignées - Com pegas - Con maniglie



(**)

542018	Fondo automático Automatic bottom	Nº 7 - 10 x 12 x 7 cm	50 u.
542019	Fond automatique Fundo automático	Nº 10 - 10 x 18 x 7 cm	50 u.
542020	Fondo automatico	Nº 16 - 16 x 18 x 7 cm	50 u.

(*) Forma elíptica con borde delantero más bajo para una apertura y utilización más fácil - Elliptical shape with lower front edge for easier opening and use - Forme elliptique avec bord avant inférieur pour une ouverture et une utilisation plus faciles - Formato elíptico com borda frontal inferior para facilitar a abertura e o uso - Forma ellittica con bordo anteriore inferiore per facilitare l'apertura e l'utilizzo

() Puntos de pegado** - Gluing points - Points de collage - Pontos de colagem - Punti di incollaggio



UTILLAJE

Tools · Outillage · Utensílios · Utensili

CÁPSULAS DE ALUMINIO

Aluminium capsules - Capsules en aluminium - Cápsulas de alumínio - Capsule in alluminio



455008

H: 1,6 cm
Ø int: 2,7 cm
Ø ext / out: 3,5 cm
 2.000 u.

455009

H: 1,6 cm
Ø int: 3 cm
Ø ext / out: 4 cm
 2.000 u.



455048

H: 1,3 cm
Ø int: 3,5 cm
Ø ext / out: 4,5 cm
 2.000 u.

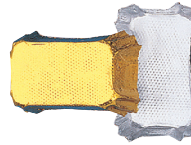

455051

H: 1,5 cm
Ø int: 4,8 x 2,6 cm
Ø ext / out: 5,2 x 3,2 cm
 2.000 u.

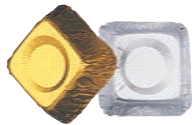

455004

H: 1,6 cm
Ø int: 2,7 x 2,7 cm
Ø ext / out: 3,7 x 3,7 cm
 2.000 u.



455005

H: 1,6 cm
Ø int: 4,4 x 3,6 cm
Ø ext / out: 5 x 4,2 cm
 1.000 u.

PAPEL DE ALUMINIO PARA REPRESENTACIONES

Aluminium paper for presentations - Papier d'aluminium pour des représentations

Papel de alumínio para apresentações - Carta d'alluminio per rappresentazioni

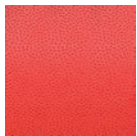

455014

10 x 10 cm
Peso / Weight:
1 Kg
 1.560 u.



455015

12 x 12 cm
Peso / Weight:
1 Kg
 1.080 u.



455017

10 x 10 cm
Peso / Weight:
1 Kg
 1.560 u.



455018

12 x 12 cm
Peso / Weight:
1 Kg
 1.080 u.



455011

10 x 10 cm
Peso / Weight:
1 Kg
 1.560 u.



455012

12 x 12 cm
Peso / Weight:
1 Kg
 1.080 u.



MOLDES DE POLICARBONATO PARA CHOCOLATE

Polycarbonate moulds for chocolates - Moules polycarbonate pour chocolat
Formas de policarbonato para chocolate - Stampi in policarbonato per cioccolato



525008
15 x 7 cm
1 molde x 3 u. / mould x 3 u.



525065
4 x 4,2 x 1,5 cm
1 molde x 15 u. / mould x 15 u.



525032
19,8 x 3,5 x H: 2,3 cm
1 molde x 4 u. / mould x 4 u.



525073
19,8 x 3,5 x H: 2,3 cm
1 molde x 4 u. / mould x 4 u.



525074
19,8 x 3,5 x H: 2,3 cm
1 molde x 4 u. / mould x 4 u.



525077
19,8 x 3,5 x H: 2,3 cm
1 molde x 4 u. / mould x 4 u.



525084
10 x 2,6 x H: 1,6 cm
1 molde x 8 u. / mould x 8 u.



525011
6 x 6 x H: 1,58 cm
1 molde x 18 u. / mould x 18 u.



UTILLAJE

Tools · Outillage · Utensílios · Utensili



NEW

525096

7 x 6,6 cm · H: 2 cm

1 molde / mould x 6 u.



NEW

525050

3,1 x 2,7 x H: 1,4 cm

1 molde / mould x 30 u.



525038

7,5x7 cm · H: 2,2cm · 3D

1 molde / mould x 6 u.



525027

4,5x4,2cm · H:1,6 cm · 3D

1 molde / mould x 12 u.



525026

3,3x3,3 cm · H:1,5 cm · 3D

1 molde / mould x 24 u.



525082

3,3 x 3,3 x H: 1,5 cm

1 molde / mould x 24 u.



525083

2,5 x 2,5 x H: 1,5 cm

1 molde / mould x 30 u.



525024

4,3 x 2,6 x H: 1,6 cm

1 molde / mould x 20 u.



525173

Ø 2,8 x H: 1,8 cm

1 molde / mould x 28 u.



525080

Ø 3,7 x 3,1 x H: 1,6 cm

1 molde / mould x 28 u.



525081

3,5 x 2,3 x H: 4,6 cm

1 molde / mould x 36 u.



525334

3,3 x 2,5 x H: 1,2 cm

1 molde / mould x 24 u.



525007

2,8 x 2 x H: 1,7 cm

1 molde / mould x 28 u.



525197

Ø 2,7 x H: 2 cm

1 molde / mould x 30 u.



525014

Ø 3,5 x H: 1,5 cm

1 molde / mould x 24 u.



525054

9,6 x 2,2 x H: 1,7 cm

1 molde / mould x 10 u.



525029

5,2 x 2,6 x H: 1,4 cm

1 molde / mould x 21 u.



525046

Ø 2,6 x H: 2,3 cm

1 molde / mould x 28 u.



525175

2,6 x 2,6 x H: 2 cm

1 molde / mould x 30 u.



525060

Ø 3 x H: 1,5 cm

1 molde / mould x 24 u.



525003

Ø 3 cm

1 molde / mould x 28 u.



525004

3,47 x 2,2 cm

1 molde / mould x 35 u.



MOLDES POLICARBONATO MAGNÉTICO

Polycarbonate mould with Magnets - Moule polycarbonate avec aimants
Stampo polycarbonato con calamite



NEW

525153

16 x 7 x H: 12 cm · 3D

☞ x 1 u.



525009

2,6 x 2,6 x 2,6 cm · 3D

☞ 1 molde / mould x 28 u.



Molde de polycarbonato con imanes para pralinés 3D

Ideal para ser utilizado con máquinas de dosificación automática. Compuesto por tres partes: base y tapa, equipadas con imanes, que definen la forma del praliné 3D y una placa perforada para alisar rápidamente el molde tras vaciar el exceso de chocolate.

Polycarbonate mould with magnets for 3D praline

Ideal to be used with automatic dosing machines. Composed of three parts: base and lid, equipped with magnets, which define the shape of the 3D praline and a perforated plate for quick smoothing of the mould after emptying the excess chocolate.

Moule en polycarbonate avec aimants pour pralinés 3D

Idéal pour être utilisé avec des doseurs automatiques. Composé de trois parties : la base et le couvercle, équipés d'aimants, qui définissent la forme de la praline 3D et d'une plaque perforée pour un lissage rapide du moule après avoir vidé l'excès de chocolat.

Molde de polycarbonato com imanes para pralinas 3D

Ideal para ser utilizado com máquinas doseadoras automáticas. Composto por três partes: base e tampa, equipada com imanes, que definem a forma da pralina 3D e uma placa perfurada para o alisamento rápido do molde após o esvaziamento do excesso de chocolate.

Stampo in polycarbonato con calamite per la realizzazione di praline 3D

Ideale da essere utilizzato con le macchine dosatrici automatiche. Composto da tre parti: da base e coperchio, dotate di calamite, che definiscono la forma della pralina 3D e da una placca forata per una veloce lisciatura dello stampo dopo lo svuotamento del cioccolato in eccesso.



525017

3,1 x 2,7 cm · H: 2,1 cm · 3D

☞ 1 molde / mould x 28 u.



525035

2,3 x 3,2 x H: 2,3 cm · 3D

☞ 1 molde / mould x 28 u.



Pralinés 3D compatibles con OneShot

Diseñados con características que los hacen aptos para su uso con máquinas dosificadoras OneShot, estos moldes de polycarbonato para pralinés permiten una alta productividad, típica de las grandes realidades artesanales e industriales.

One Shot friendly 3D pralines

Designed with features that make them suitable for use with OneShot dosing machines, these polycarbonate moulds for pralines allow high productivity, typical of large artisan and industrial realities.

Pralines 3D conviviales One Shot

Conçus avec des caractéristiques qui les rendent aptes à être utilisés avec les doseurs OneShot, ces moules en polycarbonate pour pralines permettent une productivité élevée, typique des grandes réalités artisanales et industrielles.

Pralines One Shot 3D

desenhadas com características que as tornam adequadas para utilização com as máquinas doseadoras OneShot, estes moldes de polycarbonato para pralinas permitem uma alta produtividade, típica das grandes realidades artesanais e industriais.

Le praline 3D One Shot friendly

Studiate con caratteristiche che le rendono adatte ad essere usate dalle macchine dosatrici OneShot, questi stampi in polycarbonato per praline, consentono un'alta produttività, tipica anche delle grandi realtà artigianali ed industriali.



525034

Ø 2,6 cm x H: 2,4 cm

☞ 1 molde / mould x 28 u.



UTILLAJE

Tools · Outillage · Utensílios · Utensili

MOLDES · MOULDS · MOULES · FORMAS · STAMPI



525117

12 x 12 cm

 1 molde / mould

525115

6,1 x 3 cm

 1 molde / mould

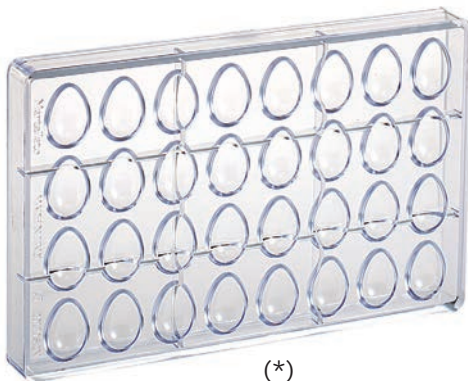

(*)



(**)

MOLDES POLICARBONATO

Polycarbonate moulds - Moules polycarbonate - Formas policarbonato - Stampi in policarbonato

* 525033	2,2 x 3,2 cm	7 g	32 mitades cada molde 32 halves · 32 moitiés · 32 metà · 32 metades	 1 molde / mould
* 525013	7,2 x 10,5 cm	70 g	4 mitades cada molde 4 halves · 4 moitiés · 4 metà · 4 metades	 1 molde / mould
* 525016	9 x 13 cm	150 g	2 mitades cada molde 2 halves · 2 moitiés · 2 metà · 2 metades	 1 molde / mould
* 525015	10,4 x 15 cm	230 g	2 mitades cada molde 2 halves · 2 moitiés · 2 metà · 2 metades	 1 molde / mould
* 525313	14,1 x 20,4 cm	380 g	1 mitad cada molde 1 half · 1 demi · 1 metà · 1 metade	 1 molde / mould
** 525311	25,8 x 17,5 cm	500 g	1 mitad cada molde 1 half · 1 demi · 1 metà · 1 metade	 1 molde / mould

UTILLAJE

Tools · Outillage · Utensílios · Utensili
 MOLDES · MOULDS · MOULES · FORMAS · STAMPI



CHOCOFRUIT



MOLDE PERA 3D 525040

H: 3,6 cm
 Ø 2,6 cm
 1 molde / mould
 (3 bases) x 28 u.



MOLDE MANZANA 3D 525018

H: 2,7 cm
 Ø 2,8 cm
 1 molde / mould
 (3 bases) x 28 u.

MOLDES DE PLÁSTICO TERMOFORMADO

Thermoformed plastic mould - Moule plastique thermoformé
 Stampo in plastica termoformata - Molde plástico termoformado



529075

22 x 16 x H: 8,5 cm

1 mitad cada molde
 1 half · 1 demi · 1 metà · 1 metade

1 molde / mould

529076

15,4 x 11 x 5,5 cm

2 mitades cada molde
 2 halves · 2 moitiés · 2 metà · 2 metade

1 molde / mould

525041

8 x 6 x 2,5 cm

4 mitades cada molde
 4 halves · 4 moitiés · 4 metà · 4 metade

1 molde / mould



UTILLAJE

Tools · Outillage · Utensílios · Utensili

MOLDES · MOULDS · MOULES · FORMAS · STAMPI



529025 MOLDE PLÁSTICO TERMOFORMADO HUEVO DIAMANTE

Kit diamond egg thermoformed plastic mold
Kit moule plastique thermoformé oeuf diamant
Kit stampo plastica termoformata uovo diamante
Kit forma plástico termoformado ovo diamante
280 g · Ø 12 x H: 18,5 cm
Caja 5 piezas – Productividad 2 Huevos Completos
Box of 5 pieces – productivity 2 full eggs
Carton de 5 pièces – productivité 2 œufs pleins
Caixa de 5 peças – produtividade 2 ovos inteiros
Scatola da 5 pezzi – produttività 2 uova intere



529029 MOLDE PLÁSTICO TERMOFORMADO HUEVO CURVY

Kit curvy egg thermoformed plastic mold
Kit moule plastique thermoformé oeuf curvy
Kit stampo plastica termoformata uovo curvy
Kit forma plástico termoformado ovo curvy
310 g · Ø 11,5 x H: 18,5 cm
Caja 5 piezas – Productividad 2 Huevos Completos
Box of 5 pieces – productivity 2 full eggs
Carton de 5 pièces – productivité 2 œufs pleins
Caixa de 5 peças – produtividade 2 ovos inteiros
Scatola da 5 pezzi – produttività 2 uova intere
5 u.



529026 MOLDE PLÁSTICO TERMOFORMADO HUEVO HONEY

Kit honey egg thermoformed plastic mold
Kit moule plastique thermoformé oeuf honey
Kit stampo plastica termoformata uovo honey
Kit forma plástico termoformado ovo honey
270 g · Ø 12,2 x H: 18,5 cm
Caja 5 piezas – Productividad 2 Huevos Completos
Box of 5 pieces – productivity 2 full eggs
Carton de 5 pièces – productivité 2 œufs pleins
Caixa de 5 peças – produtividade 2 ovos inteiros
Scatola da 5 pezzi – produttività 2 uova intere



529078 MOLDE PLÁSTICO TERMOFORMADO GALLINA 3D

3D Hen thermoformed plastic mold
Moule plastique thermoformé poule 3D
Stampo plastica termoformato gallina 3D
Molde plástico termoformado 3D galinha
90 g · 10,8 x 7,5 x H: 12 cm
1 u.



529082 MOLDE PLÁSTICO TERMOFORMADO CONEJITO 3D

Thermoformed plastic mould rabbit 3D / Moule plastique thermoformé lapin 3D / Stampo in plastica termoformata coniglio 3D / Coelho de molde plástico termoformado
100 g · 9 x 6 x H: 15,2 cm
1 u.



529077 MOLDE PLÁSTICO TERMOFORMADO CONEJITO BABY 3D

3D bad bunny thermoformed plastic mold / Moule plastique thermoformé bébé lapin 3D / Stampo plastica termoformato 3D coniglio bambino / Molde plástico termoformado 3D bebé coelho
H: 18 cm
1 u.



529005 SET MOLDE PLÁSTICO TERMOFORMADO

Thermoformed plastic mould set / Set moule plastique thermoformé / Set stampo in plastica termoformata / Set Mmolde plástico termoformado
10/13/14/15/17,5/20 cm
Set 6 moldes/moulds



529011 SET MOLDE PLÁSTICO TERMOFORMADO

Thermoformed plastic mould set / Set moule plastique thermoformé / Set stampo in plastica termoformata / Set Mmolde plástico termoformado
5/6,5/7,5/9 cm
Set 4 moldes/moulds



UTILLAJE



Tools · Outillage · Utensílios · Utensili

MOLDES · MOULDS · MOULES · FORMAS · STAMPI



NEW

529058

MOLDE PLÁSTICO TERMOFORMADO 3D
3D thermoformed plastic mold
Moule plastique thermoformé 3D
Stampo plastica termoformato 3D
Molde plástico termoformado 3D
11,9 x 5,2 x H: 12,6 cm

x 2 u.



NEW

529061

MOLDE PLÁSTICO TERMOFORMADO 3D
3D thermoformed plastic mold - Moule plastique thermoformé 3D - Stampo plastica termoformato 3D - Molde plástico termoformado 3D
21 x 6,4 cm

x 1 u.



NEW

529059

MOLDE PLÁSTICO TERMOFORMADO 3D
3D thermoformed plastic mold - Moule plastique thermoformé 3D - Stampo plastica termoformato 3D - Molde plástico termoformado 3D
6 x 3,1 x H: 9,2 cm · 3D

x 4 u.



NEW

529050

MOLDE PLÁSTICO TERMOFORMADO 3D
3D thermoformed plastic mold - Moule plastique thermoformé 3D - Stampo plastica termoformato 3D
Molde plástico termoformado 3D
A: 14 x 5 x 1 cm
B: 11,7 x 3 x 1,5 cm

x 2 u.



NEW

529051

MOLDE PLÁSTICO TERMOFORMADO 3D
3D thermoformed plastic mold
Moule plastique thermoformé 3D
Stampo plastica termoformato 3D
Molde plástico termoformado 3D
12 x 5,2 x 1,3 cm

x 4 u.



UTILLAJE

Tools · Outillage · Utensílios · Utensili

MOLDES · MOULDS · MOULES · FORMAS · STAMPI



ARO INOX. PARA MOUSSE

Stainless steel ring for mousse - Arc inox. pur mousse
Aro inox. para mousse - Anello inox per mousse

527273

25,8 x 15,4 x H: 2 cm

 1 u.

527274

21,6 x 11,2 x H: 2 cm

 1 u.



ARO INOX. PARA GIANDUIA

Stainless steel ring for mousse - Arc inox. pur mousse
Aro inox. para mousse - Anello inox per mousse

527037

30,3 x 13,5 x H: 2 cm

 1 u.

527272

23 x 6,3 x H: 2 cm

 1 u.



CUBIERTA GIANDUIA

527265

28,4 x 11,6 x H: 8 cm
1400 ml

 Set 4 piezas /
pieces

ENFRÍA DOS VECES MÁS RÁPIDO QUE LA SILICONA

It cools 2 times faster than silicone / Ça refroidi 2 fois plus vite que la silicone / Arrefece duas vezes mais rápido do que o silicone / Si raffredda due volte più veloce rispetto al silicone

UTILLAJE





Tools · Outillage · Utensílios · Utensili

MOLDES · MOULDS · MOULES · FORMAS · STAMPI



AROS PARA SEMIFRÍOS PLÁSTICO





Semi-frozen dessert rings plastic - Anneaux en plastique pour semi-froids - Aros para semifrios plástico - anelli per semifreddi in plastica

535248	Ø 7,5 cm x H: 5 cm	 1 u.
535250	Ø 24 cm x H: 5 cm	 1 u.
535253	Ø 28 cm x H: 5 cm	 1 u.



MOLDE ARO ACERO INOX.









Stainless ring mould
Moule rond inox
Forma round inox
Stampo anello acciaio inox

527258	Ø 18 x H: 4 cm	 1 u.
527259	Ø 20 x H: 4 cm	 1 u.
527260	Ø 22 x H: 4 cm	 1 u.
527261	Ø 24 x H: 4 cm	 1 u.
527262	Ø 28 x H: 4 cm	 1 u.



MOLDE ARO ACERO INOX.

Stainless ring mould
Moule rond inox
Forma round inox
Stampo anello acciaio inox

527025	Ø 8 cm · H: 2 cm	 1 u.
527003	Ø 14 cm · H: 2,5 cm	 1 u.
527012	Ø 18 cm · H: 2,5 cm	 1 u.
527016	Ø 22 cm · H: 2,5 cm	 1 u.
527018	Ø 24 cm · H: 2,5 cm	 1 u.
527020	Ø 18 cm · H: 3,5 cm	 1 u.
527021	Ø 22 cm · H: 3,5 cm	 1 u.
527022	Ø 24 cm · H: 3,5 cm	 1 u.



UTILLAJE

Tools · Outillage · Utensílios · Utensili

MOLDES · MOULDS · MOULES · FORMAS · STAMPI



MOLDE CUADRADO ACERO INOX.

Square stainless mould

Moule carré inox

Forma square inox

Stampo quadrato acciaio inox.

527270

20 x 20 x H: 2 cm

 1 u.

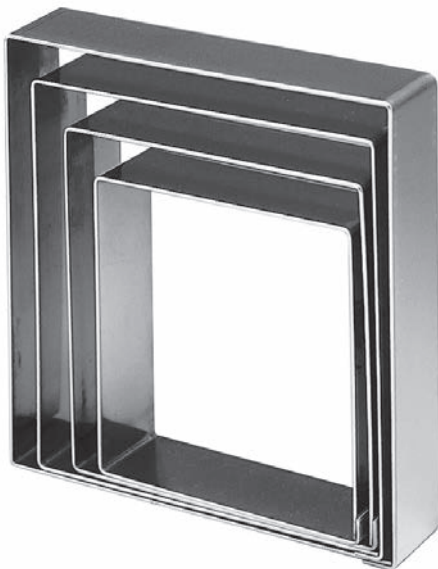

MOLDE CUADRADO ACERO INOX.

Square stainless mould

Moule carré inox

Forma square inox

Stampo quadrato acciaio inox.

527023

14 x 14 cm · H: 2,5 cm

 1 u.

527024

18 x 18 cm · H: 2,5 cm

 1 u.

527028

14 x 14 cm · H: 3,5 cm

 1 u.

527029

18 x 18 cm · H: 3,5 cm

 1 u.



MOLDE CORAZÓN ACERO INOX.

Heart mould inox.

Moule coeur inox.

Molde em forma de coração inox.

Stampo inox. cuore

527107

ø 18 cm · H: 4 cm ·  1 u.

UTILLAJE



Tools · Outillage · Utensílios · Utensili

MOLDES · MOULDS · MOULES · FORMAS · STAMPI



KIT CAKE IDEA TRILOGY

527269

Ø 18 x H:4 cm
950 ml

Set 3 piezas
/ pieces

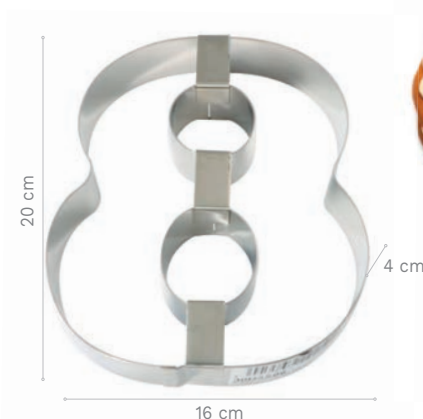

nº 0 527295	20 x 16 cm	1 u.
nº 1 527286	20 x 9,3 cm	1 u.
nº 2 527287	20 x 16 cm	1 u.
nº 3 527288	20 x 16 cm	1 u.
nº 4 527289	20 x 17 cm	1 u.
nº 5 527290	20 x 16 cm	1 u.
nº 6 527291	20 x 16 cm	1 u.
nº 7 527292	20 x 16 cm	1 u.
nº 8 527293	20 x 16 cm	1 u.
nº 9 527294	20 x 16 cm	1 u.



RECETA TARTA PARA MOLDE "KIT IDEA". ESCANEA ESTE CÓDIGO QR Y MIRA CÓMO HACERLO

Cake recipe for mould "kit idea". Scan this qr code and see how to do it!

Recette de gâteau pour moule "kit idée". Scannez ce code qr et regardez comment le faire.

Receita bolo para forma "kit ideia". Scanea este código e olhar como fazer.

ricetta per lo stampo "kit idea". Scansionare il codice QR per scoprire come realizzarlo



UTILLAJE

Tools · Outillage · Utensílios · Utensili
MOLDES · MOULDS · MOULES · FORMAS · STAMPI



YouTube

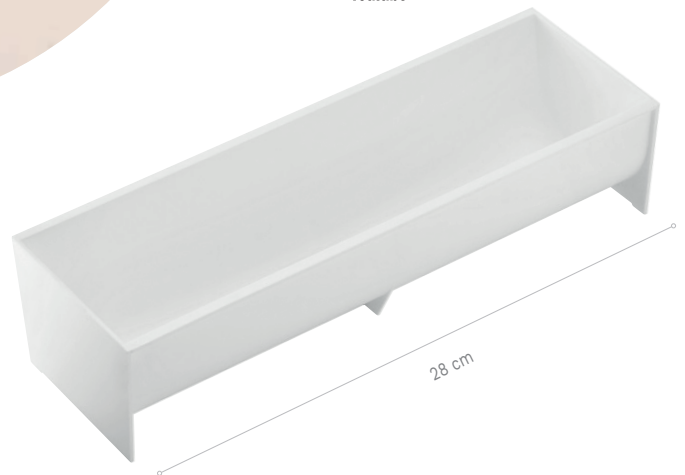

MOLDE TRONCO

Yule log cake tin - Moule bûche
Forma tronco - Stampo tronco

535243

28 x 8,5 x 6,5 cm ·  1 u.



PLACA MONOPORCIÓN INDIVIDUAL

Single portion individual plate - Plaque monoportion
individuelle - Placa mono porção individual - Piastra
monoporzione individuale

40 x 60 cm 35 piezas / pieces de ø 6,5 cm x H: 4 cm
Peso / Weight: 75 g

543109



 1 u.



MOLDE CONO A. INOX

Stainless cannoli mould
Moule cannoli inox
Forma cannoli inox
Stampo cono inox

527030

Ø 3,5 x H: 14 cm · 12 u.

527031

Ø 4 x H: 16 cm · 12 u.



YouTube

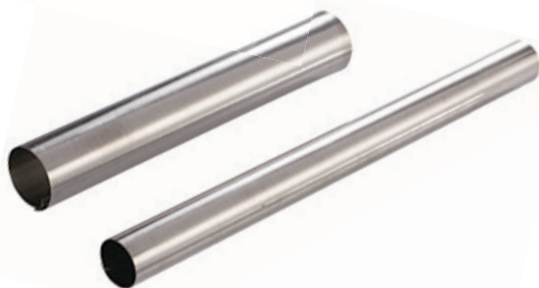

MOLDE TUBO A. INOX

Stainless cannoli mould
Moule cannoli inox
Forma cannoli inox
Stampo tubo inox

527013

2,2 x 14 cm · 10 u.

527027

1,6 x 20 cm · 12 u.

Moldes de tubos de acero inoxidable
Para hacer espirales de diferentes tipos de masas y rellenar con cremas y espumas, dulces o saladas. Modo de empleo: Engrasar el molde antes de usar, con hojaldre o tiras de masa preparadas de acuerdo con su receta, y envolver alrededor del molde y hornear. Dejar enfriar y rellenar, también se puede freír.

Moldes de conos de acero inoxidable
Para canutillos, barquillos, croasanes. Modo de empleo: Engrasar el molde antes de usar, con hojaldre o tiras de masa preparadas de acuerdo con su receta, envolver alrededor del molde y hornear, deje enfriar, y rellenar.

Stainless steel tube moulds
For making spirals with different types of pastry and dough, for filling with sweet or savoury creams and mousses. How to use it: Grease the mould before using it with puff pastry or strips of dough made following your own recipe. Wrap them around the mould and bake. Let the dough cool before filling. Can also be used for frying.

Stainless steel cone moulds
For tube or cone-shaped pastries and

croissants. How to use it: Grease the mould before using it with puff pastry or strips of dough made following your own recipe. Wrap them around the mould and bake. Let the dough cool before filling.

Moules à tubes en acier inoxydable
Pour faire des spirales de différents types de pâte et fourrer de crèmes et de mousses, sucrées ou salées. Mode d'emploi : graisser le moule avant utilisation, puis avec de la pâte feuilletée ou des bandes de pâte préparées selon votre recette, enrrouler autour du moule et cuire. Laissez refroidir et fourrer. Vous pouvez également les faire frire.

Moules coniques en acier inoxydable
Pour préparer des éclairs, des gaufrettes, et des croissants. Mode d'emploi : graisser le moule avant utilisation, puis avec de la pâte feuilletée ou des bandes de pâte préparées selon votre recette, enrrouler autour du moule et cuire au four. Laissez refroidir et fourrer.

Moldes de tubos de aço inoxidável
Para fazer espirais de diferentes tipos de massa e encher com cremes e

espumas, doces ou salgadas. Como usar: Unte o molde antes de usar, com massa folhada ou tiras de massa preparadas de acordo com a sua receita, e enrole ao redor do molde e asse. Deixe arrefecer e encha, também pode fritar.

Moldes de conos de aço inoxidável
Para canudinhos, bolachas, croissants. Como usar: Unte o molde antes de usar, com massa folhada ou tiras de massa preparadas de acordo com a sua receita, enrole ao redor do molde e asse, deixe arrefecer e encha.

Stampi a tubo in acciaio inossidabile.
Ideali per creare spirali di composti differenti e riempire con creme o spume, sia dolci che salate. Modalità d'uso: Ungere lo stampo prima dell'uso. Con pasta sfoglia o fogli di pasta preparati secondo la ricetta di preferenza, avvolgere intorno allo stampo e infornare. Lasciar raffreddare e riempire. Si può anche friggere.

Stampi a cono di acciaio inossidabile.
Per cannoncini, barchette, croissant. Modalità d'uso: Ungere lo stampo prima dell'uso. Con pasta sfoglia o fogli di pasta preparati secondo la ricetta di preferenza, avvolgere intorno allo stampo e infornare. Lasciar raffreddare e riempire.



UTILLAJE

Tools · Outillage · Utensílios · Utensili

MOLDES · MOULDS · MOULES · FORMAS · STAMPI

FLEXIPAN®



DEMARLE

MOLDES DE SILICONA DE ALTA TECNOLOGIA

Solidez, duración y propiedades antiadherentes excepcionales

El Flexipan® es una combinación de fibra de vidrio y de silicona, lo que le da solidez y duración de vida inigualables, así como propiedades antiadherentes excepcionales.

El Flexipan® está autorizado por NSF® (National Safety Foundation) desde febrero de 1997. Garantiza al utilizador de nuestros productos una seguridad absoluta en cuanto a higiene y no toxicidad. Además, Demarle puede contar con la ventaja de estar admitido por la NFHSA y la FDA (Food and Drug Administration - EEUU). Todos los productos están aprobados por el LNE francés.

Todos los productos Demarle cumplen por otra parte con las legislaciones francesa, europea y norteamericana vigentes referentes a los materiales destinados al contacto con alimentos.

Consejos de utilización:

- **Relleno:** Siempre coloque su Flexipan® sobre una placa o una rejilla de cocción antes del relleno para facilitar su transporte. Rellene las formas vacías con agua.
- **Cocción:** El Flexipan® puede usarse en cualquier tipo de horno, pero sin contacto directo con la fuente de calor (por ejemplo, una llama). El tiempo y la temperatura de cocción deben estar adaptados según el horno utilizado. Es preferible utilizar una placa perforada o una rejilla con el fin de optimizar la circulación del aire caliente. Por regla general, conviene desmoldar desde la salida del horno. Para productos más delicados como Gênoises y Dacquoises, es preferible dejar enfriar antes de desmoldar.
- **Desmoldeo:** El desmoldeo se hace muy sencillamente por deformación del molde, dando la vuelta a la placa o bien para pequeñas formas levantando los bordes del Flexipan®. No use cuchillos u objetos contundentes en el Flexipan®.
- **Limpeza:** El Flexipan® se limpia fácilmente en agua caliente con una esponja suave y detergente de pH neutro. Se aconseja lavarlo muy regularmente, la acumulación de grasa resulta nefasta para la longevidad del material.
- **Almacenamiento:** Almacenar los Flexipan® por pilas de 6 como máximo.

La etiqueta NSF®

ORGANISMO CERTIFICADOR: NSF INTERNACIONAL. (Nacional Safety Foundation, organismo americano mundialmente reconocido) - 148 Avenue Grandchamps 1150 BRUXELLES (Belgique). REFERENCIA: NSF/ANSI STANDARD 2.

CARACTERÍSTICAS CERTIFICADAS: NSF/ANSI Standard 2 establece las exigencias mínimas en lo que atañe a la protección de los alimentos e higiene para los materiales, la concepción, la fabricación, la construcción y la prestación de los equipamientos vinculados con la manipulación y la preparación de los alimentos.

La marca NF Higiene alimentaria. ORGANISMO CERTIFICADOR: AFAQ AFNOR Certification, 11 Rue Francis de Pressensé 93571. LA PLAINE SAINT DENIS CEDEX - FRANCE. REFERENCIA: NF 031. CARACTERÍSTICAS CERTIFICADAS: aptitud a la limpieza. Estos productos cumplen con el reglamento 1935/2004 del Parlamento Europeo y del Consejo del 27 de octubre de 2004 refiriéndose a los materiales y objetos destinados a entrar en contacto con los productos alimenticios.

HIGH TECHNOLOGY SILICON MOULDS

Solid, long-lasting and with exceptional non-stick properties

The Flexipan® is authorized by the NSF® (National Safety Foundation) from February 1997. It guarantees the user of our products a total security with regards to hygiene and non-toxicity. Furthermore, Demarle has also the advantage to be admitted by the NFHSA and the FDA (Food and Drug Administration - USA). All of our products are approved by the French LNE.

All Demarle products comply with the current French, European and American regulations in regards to the materials intended to get into contact with food. Instructions for use:

- **Filling:** Always place your Flexipan® on a plate or cooking grate before filling it to make it easy to carry later. Fill the empty spaces with water.
- **Baking:** The Flexipan® can be used in any kind of oven but not in contact with the direct heating source (for example, a flame). The baking time and temperature must be adequate according to the oven you are using. It is recommended to use a perforated plate or a cooking grate in order to optimize the hot air flow. Normally, it is better to unmould it right after taking it out of the oven. For more delicate products like Gênoises and Dacquoises it is better to allow it to cool down a little before unmoulding.
- **Unmoulding:** It is really easy to unmould because by means of the mould deformation, turning the plate or, in regards to the small forms, by lifting the edges of the Flexipan®. Do not use knives or blunt objects on the Flexipan®.
- **Cleaning:** The Flexipan® is easily cleaned in hot water with a soft sponge and pH-neutral detergent. It is recommended to wash it on a regular basis. The accumulation of fat can be detrimental for the lifespan of the product.
- **Storage:** Store the Flexipan® in stacks of 6 pieces at most.

The NSF® label

CERTIFYING BODY: NSF INTERNATIONAL (National Safety Foundation, world-wide recognised American body) - 148 Avenue Grandchamps 1150 BRUSSELS (Belgium). REFERENCE: NSF/ANSI STANDARD 2.

CERTIFIED FEATURES: NSF/ANSI Standard 2 establishes the minimum requirements with regards to the provision of equipment intended for the preparation and handling of food.

The NF food hygiene label. CERTIFYING BODY: AFAQ AFNOR Certification, 11 Rue Francis de Pressensé 93571. LA PLAINE SAINT DENIS CEDEX - FRANCE. REFERENCE: NF 031.

CERTIFIED FEATURES: Cleaning suitability. These products comply with the regulations 1935/2004 of the European Parliament and the Council of 27 September 2004 with regards to the materials and objects intended to get into contact with food.

TUTORIAL RECETA MOLDE FLEXIPAN®

Flexipan® mould recipe - Recette pour moule en Flexipan®
Receita forma Flexipan® - Tutorial ricetta stampo Flexipan®



YouTube



UTILLAJE



Tools · Outillage · Utensílios · Utensili

MOLDES · MOULDS · MOULES · FORMAS · STAMPI

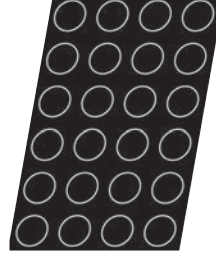
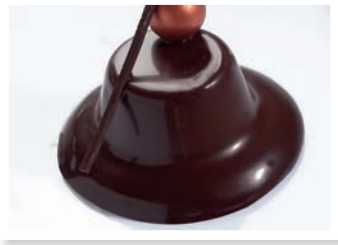
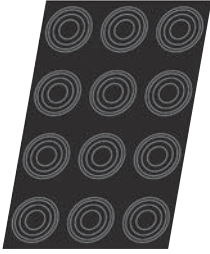

CROWN MUFFIN 528166

PLACA / Plates
60 x 40 cm

FORMA / Form
9 x 8,5 cm



x 12

SEMI ESFERAS 528050

PLACA / Plates
60 x 40 cm

FORMA / Form
Ø 7 x H: 4 cm



x 24

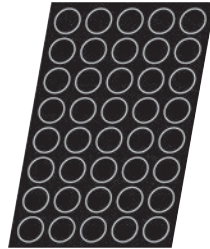

MINI FLORENTINAS 528025

PLACA / Plates
60 x 40 cm

FORMA / Form
Ø 5,9 x H: 1,3 cm



x 40

528082

Medida / Size
33,5 x 13 cm

FORMAS / Forms
1

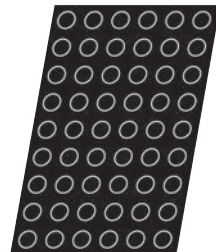

CAMPANA 528557

PLACA / Plates
60 x 40 cm

FORMA / Form
10,2 x 9,2 x H: 2,9 cm



x 15

PETITS FOURS 528031

PLACA / Plates
60 x 40 cm

FORMA / Form
Ø 4 x H: 2 cm



x 54



YouTube



UTILLAJE

Tools · Outillage · Utensílios · Utensili
MOLDES · MOULDS · MOULES · FORMAS · STAMPI



f FLEXIPAN
INSPIRATION

Gama FLEXIPAN® INSPIRATION Ha inspirado a más de uno.

Alto rendimiento de la marca Flexipan® para formas rectas, complejas y detalladas.

Idónea para la producción semiindustrial e industrial, así como el desmoldeo automatizado.

FLEXIPAN® INSPIRATION range. He has inspired more than one. Flexipan® brand high performance for shapes straight, complex and detailed. Ideal for semi-industrial and industrial production, as well as automated demolding.

Gamme FLEXIPAN® INSPIRATION. Il en a inspiré plus d'un. Marque Flexipan® haute performance pour les formes droit, complexe et détaillé. Idéal pour la production semi-industrielle et industrielle, ainsi que le démoulage automatisé.

Gama FLEXIPAN® INSPIRAÇÃO. Ele inspirou mais de um. Marca Flexipan® de alto desempenho para formas direto, complexo e detalhado. Ideal para produção semi-industrial e industrial, bem como desmoldagem automatizada.

Gamma FLEXIPAN® INSPIRATION. Ne ha ispirato più di uno. Marchio Flexipan® ad alte prestazioni per le forme diretto, complesso e dettagliato. Ideale per la produzione semi-industriale e industriale, così come la sformatura automatizzata.



NEW 528369

Medida / Size
Ø 22 x H: 4,5 cm

FORMAS / Forms
1



NEW 528477

Medida / Size
22 x 22 x H: 4,5 cm

FORMAS / Forms
1



NEW 528255

Medida / Size
57,5 x 37,5 x H: 5 cm

FORMAS / Forms
1

UTILLAJE



Tools · Outillage · Utensílios · Utensili

MOLDES · MOULDS · MOULES · FORMAS · STAMPI

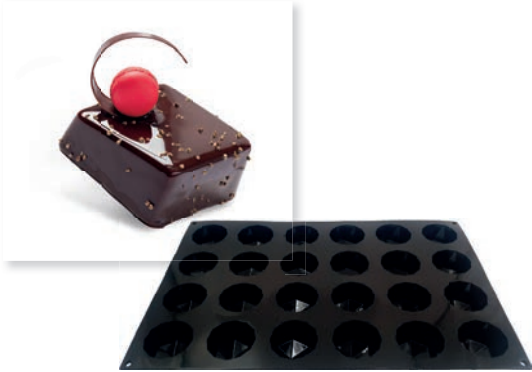

NEW

528495

PLACA / Plates 60 x 40 cm FORMA / Form 7 x 7 x H: 3,4 cm FORMAS / Forms 24



NEW

528505

PLACA / Plates 30 x 20 cm FORMA / Form Ø 4,5 x H: 4,85 cm FORMAS / Forms 8



NEW

528504

PLACA / Plates 60 x 40 cm FORMA / Form Ø 7,9 x H: 4 cm FORMAS / Forms 24



NEW

528486

PLACA / Plates 60 x 40 cm FORMA / Form Ø 7 x H: 4 cm FORMAS / Forms 24



NEW

528086

PLACA / Plates 40 x 30 cm FORMA / Form 6,5 x 3,6 x H: 2,7 cm FORMAS / Forms 30



NEW

528413

PLACA / Plates 40 x 30 cm FORMA / Form 8 x 12,7 x H: 1,5 cm FORMAS / Forms 8



UTILLAJE

Tools · Outillage · Utensílios · Utensili

MOLDES · MOULDS · MOULES · FORMAS · STAMPI



MINI MUFFINS 528475

PLACA / Plates 60 x 40 cm FORMA / Form Ø 5 x H: 2,8 cm x 54
Vol. 40 ml



MUFFINS 528473

PLACA / Plates 60 x 40 cm FORMA / Form Ø 6,9 x H: 3,9 cm x 24
Vol. 120 ml



DONUTS 528467

PLACA / Plates 60 x 40 cm FORMA / Form Ø 7,5 x H: 2,5 cm x 24
Vol. 90 ml



CORAZÓN 528468

PLACA / Plates 60 x 40 cm FORMA / Form 7,5 x 6,8 x H: 3 cm x 24
Vol. 90 ml



ECLAIR 528469

PLACA / Plates 60 x 40 cm FORMA / Form 13 x 3 x H: 2,8 cm x 28
Vol. 85 ml



MADELEINE 528470

PLACA / Plates 60 x 40 cm FORMA / Form 7,4 x 4,5 x H: 1,8 cm x 44
Vol. 35 ml



ESFERA 528474

PLACA / Plates 60 x 40 cm FORMA / Form Ø 7 x H: 3,5 cm x 20
Vol. 90 ml



MINI ESFERA 528476

PLACA / Plates 60 x 40 cm FORMA / Form Ø 3,5 x H: 1,75 cm x 96
Vol. 10 ml

UTILLAJE



Tools · Outillage · Utensílios · Utensili

MOLDES · MOULDS · MOULES · FORMAS · STAMPI



528201

Ø 4 x 2 cm

1 u. 15 formas / forms



528215

Ø 4 x 2 cm

1 u. 15 formas / forms



528202

Ø 7 x 3,5 cm

1 u. 15 formas / forms



528515

7,9 x 2,9 x H: 3 cm · 1 u. 12 formas / forms

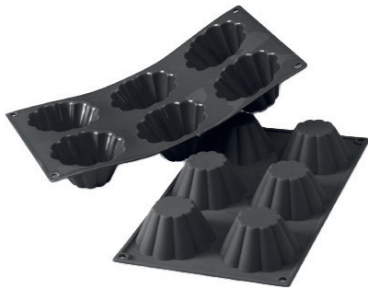

528350

Ø 7,9 x 3,7 cm

1 u. 6 formas / forms



528353

Ø 6,8 x 3,8 cm

1 u. 6 formas / forms



528361

Ø 7,5 x 2,5 cm

1 u. 6 formas / forms

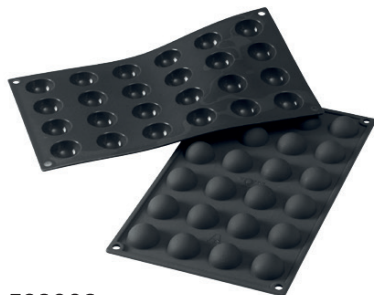

528008

Ø 3 x H: 1,5 cm

1 u. 24 formas / forms



528010

Ø 6 x H: 3 cm

1 u. 6 formas / forms



528203

Ø 8 x H: 4 cm

1 u. 5 formas / forms



528426

Ø 6,8 x 4,5 x H: 1,7 cm

1 u. 9 formas / forms



528200

Ø 3,4 x 1,6 cm

1 u. 24 formas / forms



528137

Ø 6,5 x 2,1 cm

1 u. 8 formas / forms



UTILLAJE

Tools · Outillage · Utensílios · Utensili

MOLDES · MOULDS · MOULES · FORMAS · STAMPI

SILICONFLEX Y UNIFLEX

Siliconflex and Uniflex moulds - Siliconflex et Uniflex moules - Formas Siliconflex e Uniflex
Forme Siliconflex e Uniflex

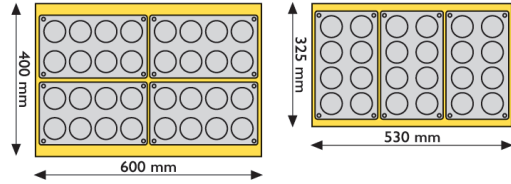

H.A.C.C.P.
NO PROBLEM

- Los moldes SILICONFLEX y UNIFLEX son aptos tanto para la cocción en horno como para la congelación.
- Especiales para postres, salados, chocolate y tarrinas.
- Óptimo para acaramelado del sirope.
- Preparación y decoración directamente sobre el molde.
- Ahorro en operaciones de engrase de los moldes.
- Se lava simplemente con agua caliente, con una esponja o en el lavavajillas.
- Medidas de las placas: 17,5 x 30 cm

- The SILICONFLEX and UNIFLEX moulds are suitable for both baking and freezing.
- Well suited for desserts, savoury products, chocolate and terrines.
- Optimal for caramelized syrup.
- Preparation and decoration directly on the mould.
- Saving in operations of lubrication of the moulds.
- It is simply washed with hot water, with a sponge or in the dishwasher.
- Size of the plates: 17,5 x 30 cm



528184

Ø 28 x 4,7 cm · 1 u.



528187

26 x 10 x H: 70 cm · 1 u.,



MACARONS

526094

60 x 40 · Ø 4 cm

1 u. 70 formas / forms

MACARONS

526149

30 x 40 · Ø 4 cm

1 u. 34 formas / forms



ECLAIR

526143

30 x 40 · 2,5 x 12,5 cm

1 u. 18 formas / forms



ECLAIR

Cookie cutter inox.

Coupe-pâtes inox.

Cortapastas inox.

Affetta torte inox.

543235

2,5 x 12,5 cm · 1 u.



MINI ECLAIR

526148

30 x 40 · 1,8 x 6 cm

1 u. 35 formas / forms



MINI ECLAIR

Cookie cutter inox.

Coupe-pâtes inox.

Cortapastas inox.

Affetta torte inox.

543236

1,8 x 6 cm · 1 u.

UTILLAJE

Tools · Outillage · Utensílios · Utensili

MOLDES · MOULDS · MOULES · FORMAS · STAMPI



BANDA SILICONA PERFORADA

Silicone cake ring micro bands
Bande silicone perforée
Fascia perforata in silicone

526050	50 cm · H: 2,5 cm	10 u.
526055	75 cm · H: 2,5 cm	10 u.
526066	50 cm · H: 3,5 cm	10 u.
526070	62,5 cm · H: 3,5 cm	10 u.
526073	75 cm · H: 3,5 cm	10 u.

REDUCCIÓN DEL TIEMPO DE PRODUCCIÓN

alrededor del 30% simplificando los pasos.

CERO IMPERFECCIONES

porque permite que la humedad escape.

RÁPIDO DESMOLDE SIN ROTURAS

permitiendo desmoldar tanto en caliente como en frío.

REDUCCIÓN DE COSTES

al alcanzar el 99% de éxito en la producción con menos gastos.



REDUCTION OF PRODUCTION TIMES by simplifying the steps and reducing times by around 30% **EVEN COOKING WITH ZERO IMPERFECTIONS** because they allow moisture to escape **QUICK UNMOULDING WITHOUT BREAKINGS** by allowing the unmoulding of both hot and cold products **WASTE AND COST REDUCTION** you will be 99% successful in production with less wasting

UNE RÉDUCTION DES TEMPS DE PRODUCTION grâce à la simplification des étapes et à une réduction des délais d'environ 30 % **VOS PÂTISSERIES SANS AUCUNE IMPERFECTION**, grâce à l'évacuation de l'humidité **UN DÉMOULAGE RAPIDE ET SANS CASSURES**, grâce au démoulage des pâtisseries à chaud et à froid **UNE RÉDUCTION DES DÉCHETS ET DES COÛTS**, vos productions réussies à 99 % et avec moins de déchets

REDUÇÃO DOS TEMPOS DE PRODUÇÃO, simplificando os passos e reduzindo os tempos em cerca de 30% **COZINHANDO COM ZERO IMPERFEIÇÕES** porque permitem que a humidade saia **DESMONTAGEM RÁPIDA SEM PARTIR**, permitindo a desmoldagem de produtos quentes e frios **REDUÇÃO DE RESÍDUOS E CUSTOS**, terá 99% de sucesso na produção com menos desperdício

RIDUCI IL TEMPO DI PRODUZIONE di circa il 30% semplificando i passaggi. **ZERO IMPERFEZIONI** grazie alla funzione di fuoriuscita dell'umidità. **SFORMATURA RAPIDA SENZA ROTTURA** sia a caldo che a freddo. **RIDUCI I COSTI**, grazie a un tasso di successo del 99% della produzione, per meno spese.



YouTube





LA POLIVALENCIA EN EL OBRADOR

Entre -40 °C y +300 °C
Reemplaza a los papeles de silicona
Evita el humo y la carbonización de las grasas

¿QUÉ ES EL SILPAT?

SILPAT es una hoja de caucho siliconado alimenticio, reforzado por una tela a base de "silicone"; está destinado a la cocción sobre bandejas y latas para hornear cualquier tipo de masa, aunque su uso es múltiple, ya que mantiene su antiadherencia a temperaturas negativas -40° C y positivas +300°C.

FACILIDAD DE EMPLEO Y DURACIÓN

SILPAT suprime el engrasado de las bandejas y latas, su limpieza evita el humo provocado por la cocción o la carbonización de las grasas; solución radical en aquellos productos cuya absorción de grasas adultera el sabor y la presentación del mismo. Reemplaza los papeles de silicona. Su almacenaje ocupa poco espacio. Permite poderlo utilizar nuevamente una vez limpio (entre 500 - 2.000 veces, según la naturaleza de la masa). Se interpone entre la lata y el producto, evitando, al cocer un producto, que éste adquiera los puntos negros producidos por la carbonización de los residuos de otros productos cocidos anteriormente. Limpieza con agua caliente o utilizando papel.

SUS ENEMIGOS

- No aplicar fuego directo.
- Almacenarlos en plano, nunca doblarlos.
- Las rasquetas de acero, cuchillos y pliegues que se forman si se doblan, pueden rasgarlos.
- Lavarlos con detergentes va deteriorando su garantía de antiadherencia.

THE BAKING VERSATILITY

Between -40 °C and +300 °C
It replaces the silicon papers
It avoids the smoke and the fat carbonisation

WHAT IS SILPAT?

SILPAT is a silicone rubber sheet suitable for food contact. Reinforced with a silicone fabric, it is intended for baking any kind of pastry on trays and cans. Bu it also has multiple uses since its non-stick properties remain with negative (-40°C) and positive temperatures (+300°C).

EASY TO USE AND DURABILITY

SILPAT suppresses the lubrication of trays and cans. It is clean, avoiding the smoke coming from cooking and fat carbonisation; a radical solution for those products which absorb fat and thus change their flavour and presentation. It replaces the silicon papers.

Its storage does not require much space. It can be used again and again once it is clean (between 500 and 2000 times depending on the nature of the dough). It stands between the tray and the product, thus avoiding the black spots which appear due to the carbonisation of the residues from other products that have been baked previously. You can clean it with hot water or using paper.

ITS ENEMIES

- Do not use with direct fire.
- Store them on a flat level, never fold them.
- If they are folded, the steel scrapers, blades and folds can tear them.
- To wash them with detergents can deteriorate their non-stick guarantee.

SILPAT®



528300	40 x 30 cm	1 u.
528001	60 x 40 cm	1 u.
528007	53 x 32,5 cm	1 u.
528003	75 x 45 cm	1 u.

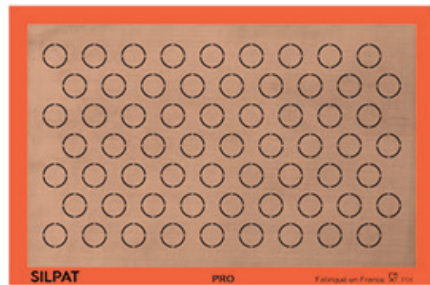

SILPAT ESPECIAL MACARONS

Special product for macarons - Produit spécial pour macarons - Produto especial para macarons

528126

PLACA / Plates	FORMA / Form	Ø FORMA / Ø Form
60 x 40 cm	63	Ø 3,5 cm



ESPECIAL MACARONS

FLEXIPAN

Special product for macarons - Produit spécial pour macarons - Produto especial para macarons - Prodotto specifico per macarons

528159

PLACA / Plates	FORMA / Form
60 x 40 cm	Ø 3,5 cm



FLEXIPAT®

- El Flexipat® permite, gracias a sus bordes, alisar o rellenar muy rápidamente cualquier tipo de preparaciones con un espesor siempre igual. Así las cocciones y congelaciones son siempre regulares.
- Permite también ganar en productividad limitando pérdidas de productos cuando se monta el postre en el marco.

 Thanks to its edges Flexipan® allows you to stretch or fill any kind of preparation really fast with always the same identical thickness. Thus, whether you bake it or freeze it, it will be regular.

- It also allows you to increase productivity and limit losses of products when the dessert is mounted on the frame.



Ref. 528000

55,5 x 36 x H: 1 cm ·  1 u..

SILPAIN®

ESTERAS PARA PANADERÍA

Entre -40 °C y +240 °C

Fermentación/ horneado/ congelado

El Silpain® es una esterilla antiadherente que es especialmente adecuada para hornear panes especiales o productos con masa crujiente (por ejemplo, pancakes crujientes o panecillos)

Malla realizada en fibra de vidrio, con recubrimiento de silicona.

Hay pequeñas perforaciones en la esterilla para una mejor transferencia de calor y una mejor corteza.

BAKINGS MATS

Between -40 °C and +240 °C

Fermentation/ baking/ freezing

A non-stick mat which is particularly suitable for baking special breads or product with crusty dough (e.g buckwheat pancakes or bread rolls)

Mesh made from fiberglass, with silicone coating.

There are small perforation in the mat for better transfer of heat and improved crustiness.

528274

30 x 40 cm ·  1 u.

528458

60 x 40 cm ·  1 u.



TAPETE PERFORADO SILICONA

Perforated silicone banking sheet

Tapis silicone perforé - Tovaglietta perforata in silicone

526074

40 cm · H: 30 cm

 1 u.

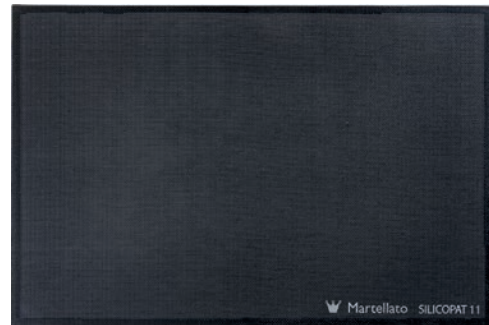

40 cm

30 cm

PAPEL SILICONADO PARA HORNEAR

Silicone oven paper - Papier siliconé pour enfourner - Papel de silicone para ornear
Carta siliconata

520001

59 x 39 cm ·  1 u.





UTILLAJE

Tools · Outillage · Utensílios · Utensili

MOLDES · MOULDS · MOULES · FORMAS · STAMPI



MOLDES DE MADERA PARA COCER

Wooden molds for cooking - Moules en bois pour la cuisine - Moldes de madeira para cozinhar - Stampi in legno per cuocere

Moldes de un solo uso, para presentaciones originales y artesanales.

 Single-use molds, for original and craft presentations.

 Moules à usage unique, pour présentations originales et artisanales.

 Moldes descartáveis, para apresentações originais e artesanais.

 Stampi monouso, per presentazioni originali e artigianali.



540283

18,5 x 11,5 x 6 cm

 100 u.



540287

25 x 11,5 x 7,5 cm

 100 u.



TAPETES PARA SWEET LACE

Mats · Napperons · Tapetes · Tappetini per sweet lace

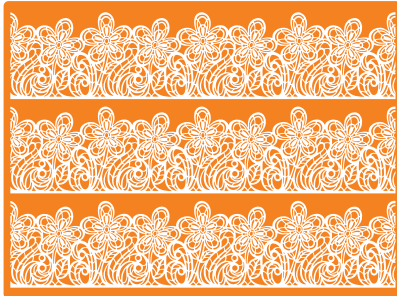

526138
 FLORES - Flowers - Fleurs
 Flores - Fiori · 30 x 40 cm · 📦 1 u.

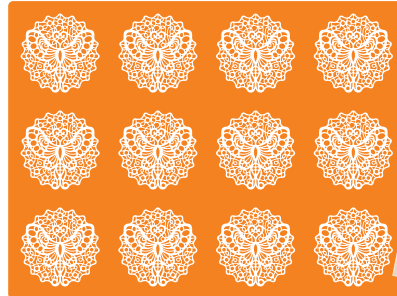

526136
 MARIPOSAS - Butterfly - Papillons - Borboletas
 Farfalle · 30 x 40 cm · 📦 1 u.

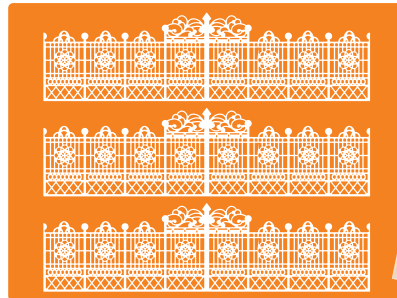



526137
 CASTILLO - Castle - Château - Castelo · Castello
 30 x 40 cm · 📦 1 u.



Tapetes de silicona ideales para aderezar tu postre con una decoración de azúcar muy efectiva. Tapetes de silicona ideales para vestir tu tarta con una impresionante decoración de azúcar. Medida - Tamaño: 30 x40 cm

 Silicone mats ideal for dressing your dessert with a highly effective sugar decoration. Silicone mats ideal to dress up your cake with an impressive sugar decoration. Measurement - Size: 30 x 40 cm.

 Tapis en silicone idéal pour habiller votre dessert d'une décoration en sucre très efficace. Tapis en silicone idéal pour habiller votre gâteau d'une impressionnante décoration en sucre. Mesure - Taille: 30 x 40 cm.

 Tapetes de silicone ideais para temperar a sua sobremesa com uma decoração de açúcar altamente eficaz. Tapetes de silicone ideais para enfeitar o seu bolo com uma impressionante decoração de açúcar. Medida - Tamanho: 30 x 40 cm.

 Tappeti in silicone ideali per vestire il tuo dolce con un decoro in zucchero di grande effetto. Silicone mats ideal to dress up your cake with an impressive sugar decoration. Misura - Size: 30x40cm



UTILLAJE

Tools · Outillage · Utensílios · Utensili



DOSIFICADOR AUTOMÁTICO ACERO & SOPORTE

Automatic dispenser. Steel & support
Doseur automatique acire & support
Dosificador automático aço & suporte
Dosatore automatico acciaio e supporto

DOSIFICADOR / Dispenser

SOPORTE / Support

535007

Ø 18,5 cm

1,9 L. ·  1 u.

535285

H: 18,5 cm

 1 u.





FUENTE DE CHOCOLATE BASE INOX.

Dish for chocolate stainless base.
Fontaine chocolat base acier inox.
Fonte de chocolate base inox.
Fontane di cioccolato base inox.

535001

Ø 39 x H: 80 cm
Capacidad / Capacity: 5 Kg
Tensión / Voltage: 220 - 249 V / 50 Hz.
Stampi in policarbonato 1 u.

NUEVO BOL - NEW BOWL - NOUVEAU BOL - NOVA TAÇA
NUOVA CIOTOLA

La forma del nuevo bowl de acero inoxidable evita que el chocolate se desborde al desmontarlo y limpiarlo.

The shape of the new stainless-steel bowl prevents the chocolate from overflowing on disassembly and cleaning.

La forme du nouveau bol en acier inoxydable empêche le chocolat de déborder sur le démontage et le nettoyage.

A forma da nova taça em aço inoxidável impede que o chocolate transborde ao desmontar ou limpar.

La forma di questa nuova ciotola in acciaio inossidabile permette di evitare che il cioccolato fuoriesca in fase di smontaggio e pulizia.



FUENTE DE CHOCOLATE PEQUEÑA BASE INOX.

Small dish for Chocolate stainless base.
Fontaine chocolat petit base acier inox.
Fonte de chocolate pequena base inox.
Fontane di cioccolato piccola base inox.

535730

Ø 21 x H: 42 cm
Capacidad / Capacity: 1,5 Kg
Potencia / Power: 70 W.
Tensión / Voltage: 230 V / 50 Hz.

1 u.

SET DE UTENSILIOS PARA CHOCOLATE DE ACERO INOX. CON MANGO DE PLÁSTICO

Set of stainless steel tools for chocolate with plastic handle - Set d'outils pour chocolat en acier inoxydable avec poignée en plastique - Set de ferramentas para chocolate de acero inox. Com cabo de plástico - Set di utensili per cioccolato in acciaio inox con manico in plastica

535395

18 cm · x 10 utensilios / tools.





UTILLAJE

Tools · Outillage · Utensílios · Utensili



YouTube



BASE GIRATORIA ELÉCTRICA

SPINNER ELECTRIC CAKE TURNTABLE

SPINNER ÉLECTRIQUE ROTARY - BASE GIREVOLE ELETTRICA

341015

27 x 26 x H: 12 cm

1 u.

- Regulador de velocidad
- Plato con escala graduada de 6 a 22 cm
- Anillo conductor circular
- Luz led que varía según la velocidad
- Plato de plexiglass
- Rotación a un lado y al otro

- Speed regulator
- Graduated plate between 2,36 and 8,66 inch
- Roller ring support
- LED brightness is proportional to the rotation speed
- Plexiglass plate
- Clockwise and anti-clockwise rotation

- Régulateur de vitesse
- Plateau gradué entre 2,36 et 8,66 pouces
- Support sous la forme d'un anneau à roulettes
- Luminosité LED proportionnelle à la vitesse de rotation
- Plateau en plexiglass
- Rotation dans les deux sens

- Régulateur de vitesse
- Plateau gradué entre 2,36 et 8,66 pouces
- Support sous la forme d'un anneau à roulettes
- Luminosité LED proportionnelle à la vitesse de rotation
- Plateau en plexiglass
- Rotation dans les deux sens

- Regolatore di velocità
- Piatto con scala graduata da 6 a 22 cm
- Anello conduttore circolare
- Luce LED che varia a seconda della velocità
- Piatto in plexiglass
- Rotazione da un lato all'altro



623001

MINI MELTIN CHOC ROJO

Práctico y colorido, Mini es el fundidor ideal en el laboratorio de pastelería para pequeñas cantidades de bombones y temas de chocolate, así como en heladerías para postres glaseados en barra. La apariencia moderna lo convierte en un objeto de diseño ideal para ser utilizado directamente delante de los clientes.

🇬🇧 Practical and colorful, Mini is the ideal melter in the pastry lab for small quantities of pralines and chocolate subjects, as well as in ice cream shops for glazed desserts on stick. The modern appearance make it an ideal design object to be used directly in front of customers

Dimensiones /Dimensions (cm): 26 x 26 x H: 16 - Capacidad /Capacity: 1,8 L.



ATEMPERADOR DE CHOCOLATE

Chocolate temperature controller
Tempérer le chocolat
Temperador de chocolate
Attempereatore cioccolato

★ **623004**

Cubeta móvil / Mobile cover
Ø 51 x 40 x H: 26,5 cm
Capacidad / Capacity: 12 L.
(10 Kg de cobertura)
1.000 W. · 220 - 240 V.
Monofásico / monophasic
Peso / Weight: 5,5 Kg



623002

FUNDIDOR EN SECO DISEÑO PARA HELADERÍAS

Atemperador de Chocolate diseñado pensando en la Heladería, gracias a su forma y su medida es ideal para el recubrimiento de chocolate en los helados y semifríos con palo. Presentado con un color clásico que nos recuerda al chocolate, para adaptarse a cualquier tipo de entorno y utilizarse directamente en el mostrador.

Las características técnicas de los fundidores analógicos, el termostato que permite ajustar la temperatura y la bandeja extraíble de aluminio anodizado (para facilitar la limpieza) hacen del deep meltin choc sea un artículo imprescindible

🇬🇧 Chocolate tempering machine designed with the ice cream parlour in mind. Thanks to its shape and size, it is ideal for coating chocolate on ice creams and semifreddi with a stick. Presented in a classic colour reminiscent of chocolate, to fit any environment and be used directly on the counter.

The technical features of the analogue melters, the thermostat for temperature adjustment and the removable anodised aluminium tray (for easy cleaning) make the deep meltin choc a must-have item.



CALORIBAC. MANTENEDOR DE TEMPERATURA

Maintains temperature
Mainteneur de température
Mantenedor de temperatura
Strumento di mantenimento temperatura

★ **623006**

Ø 25,4 x 18,8 cm
Capacidad / Capacity: 3,5 litros.
200 W. · 240 V. Monofásico / monophasic - Peso / Weight: 1,8 Kg



CARROS DE INGREDIENTES

Carts of ingredients - Chariots d'ingrédients - Carroças de ingredientes
Carrelli ingredienti

★ **535129**

Capacidad / Capacity: 80 L. = 77 Kg de azúcar / sugar = 64 Kg harina / flour

Tapas deslizables y transparentes. Cuerpo de polipropileno. No se oxida ni transfiere olores ni sabores.

🇬🇧 Transparent sliding covers. Polypropylene body. Stainless. It does not give smells or flavours.

🇫🇷 Couvercles amovibles et transparents. Contenant en polypropylène. Ne s'oxyde pas, ne transmet ni odeurs ni goûts.

🇵🇹 Tapas deslizantes e transparentes. Corpo em polipropileno. Não enferruja nem transfere odores ou sabores.

🇮🇹 coperci a scorrimento e trasparenti. Corpo in polipropilene. Non si ossida, non trasferisce odori e sapori.



ATEMPERADOR CHOCOLATE ANALÓGICO CUBETA (3.5 l)

Chocolate temperature controller
Tempérer le chocolat
Temperador de chocolate
Attempereatore cioccolato analogico vaschetta

★ **623000**

Dimensiones /Dimensions (cm): 41 x 23 H: 13,5 - 2,9 kg de cobertura approx./ cover - Peso/ weight: 2,7 kg Monofásico/ monophasic



UTILLAJE

Tools · Outillage · Utensílios · Utensili

ECO LINE





Versiones básicas de los artículos

-  - Alternative for starters
- Basic versions of the articles



CAJA GN 1/1 ECO LINE

Box - Case - Caixa - Scatola





				
501042	24	30,5	45	720

Interior / inside: 54,6 x 34,6 cm - Exterior / outside: 60 x 40 cm



CAJA UNIVERSAL ECO LINE

Box - Case - Caixa - Scatola





				
501041	30	36	80	1.020

Interior / inside: 63 x 43 cm - Exterior / outside: 68,5 x 48,5 cm



CAJA PIZZA ECO LINE

Box - Case - Caixa - Scatola

				
501040	17,5	23,5	21,5	650

Interior / inside: 35 x 35 cm - Exterior / outside: 41 x 41 cm



CAJAS ISOTÉRMICAS

Isothermic boxes - Boîtes isothermes - Caixas Isotérmicas - Scatole isothermiche



- A prueba de roturas (EPP, no es corcho)
- Robustas, ligeras y duraderas
- Alta capacidad aislante
- Utilizable de -40 a +120° C
- A prueba de lavavajillas, higiénicas
- Cumple estándar HACCP



- Damage proof (EPP, it is not cardboard)
- Hard, light and durable.
- High isolation capacity.
- Suitable from -40°C up to +120°C
- Dishwasher proof, hygienic.
- It complies with the HACCP standard

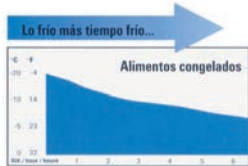

CAJA GN 1/1 CONFORT

Box - Case - Caixa - Scatola

501087	25	33	46	1.400

Interior / inside: 54 x 34 cm - Exterior / outside: 67 x 40 cm



CAJA MULTIUNIVERSAL SIN TAPA

Multi universal box with no cover - Boîte sans couvercle multiuniversel
Caixa multiuniversal sem tapa - Scatola multiuniversale senza coperchio

501011	8	12,5	21,5	700
501012	12	16,5	32	800
501014		3		305

Interior / inside: 62,5 x 42,5 cm - Exterior / outside: 68,5 x 48,5 cm



CAJA UNISTAR

Unistar box - Case Unistar - Caixa Unistar - Scatola Unistar

501006	12	18,5	33	1.270
501007	16	22	44	1.300
501010	30	36	82	1.900

Para transporte de tartas, pasteles y pastas congeladas.

Con tapa. Bandejas 60 x 40 cm Interior: 63,5 x 43,5 cm / exterior: 69,5 x 49,5 cm

To transport cakes, pies and frozen dough.

With cover. Tray 60 x 40 cm Inside: 63,5 x 43,5 cm / outside: 69,5 x 49,5 cm



Superficie interior impermeable. Fácil carga y descarga gracias al hueco. Espacio en los lados largos y en las esquinas. Superficie exterior de la más alta calidad. Mangos ergonómicos. Tapa de fácil apertura desde las esquinas. Etiquetas rígidas o flexibles para la identificación del producto.



Waterproof inside surface. Easy loading and unloading due to the recessed space on the long sides and on the corners. Highest quality outer surface. Ergonomic handles. Easy opening lid from the corners. Rigid or flexible labels for product identification.



UTILLAJE

Tools · Outillage · Utensilios · Utensili



CAJA COMBI JUNIOR UNIVERSAL LATERAL

Universal junior combi side box

501000	32,5	40,5	45,5	2.300

Interior / Inside: 60,5 x 40,5 cm - Exterior / Outside: 68 x 49 cm

Caja de carga frontal. Conveniente para cargar y descargar, Perfecta para bandejas. 3 carriles y 8,1 cm

Termómetro integrado para el control continuo de la temperatura.

Front load box. Convenient to load/unload; perfect for trays. 3 slides: each with distance of approx 8,1 cm Integrated thermometer for ongoing temperature control.



CAJA COMBI UNIVERSAL PARA BANDEJAS

DE 60 x 40 cm y 40 x 30 cm

Universal combi box for trays 60 x 40 cm and 40 x 30 cm

Combi universal box plateau 60 X 40 cm Et 40 x 30 cm

Caixa combi universal para bandejas de 60 x 40 cm y 40 x 30 cm

Scatola combinata universale per vassoio

501064	51	62	125	6.500

Interior / Inside: 62 x 40,5 cm - Exterior / Outside: 70 x 58 cm

Guías / Guides: 5/3



ACCESORIOS

Accesories - Accessoires - Accesorios - Accessori

501093

2 partes laterales guías 9/1 - 2 side pieces guides 9/1



THERMO SOPORTE MÓVIL PARA CAJA GN 1/1

Thermo mobile support

Thermo support mobile

Thermo soporte móvil

Thermo supporto mobile per scatola

501067	60 x 40 x 16	2.700	250

NPE, 4 ruedas, muy estable

NPE, 4 wheels. Very stable.

deKora



TRADE MARKETING EXPOSITORES

Stands · Présentoirs · Expositores · Espositori

EXPOSITORES - TRADE MARKETING

Stands · Présentoirs · Expositores · Espositori

EXPOSITOR METÁLICO METALLIC STAND



***No incluye ganchos**
Hooks are not included
Les crochets ne sont pas inclus
Não inclui ganchos
Non include ganci

Ejemplo de presentación
Example of presentation
Exemple de présentation
Exemplo de apresentação
Esempio di presentazione

707006
EXPOSITOR METÁLICO SOBREMESA
Metallic desk stand - Présentoir métallique pour comptoir - Expositor metálico de sobremesa - Espositore metallico da tavolo 42,5 x 24 x 71 cm



502049*
20 cm · 12 u.

707008*
30 cm · 12 u.
GANCHOS METÁLICOS
Metallic hooks
Crochets métalliques
Ganci metallici

* Compatible con / with / avec / compatível com / compatibile con Ref: 707005 & 707006



707000*
GANCHOS PORTA-PRECIO METÁLICOS

Metallic hook price holder - Crochets porte-prix métalliques - Ganchos porta preços metálicos - Ganci portaprezzo metallici
20 cm · 12 u.

* Compatible con / with / avec / compatível com / compatibile con Ref: 707001

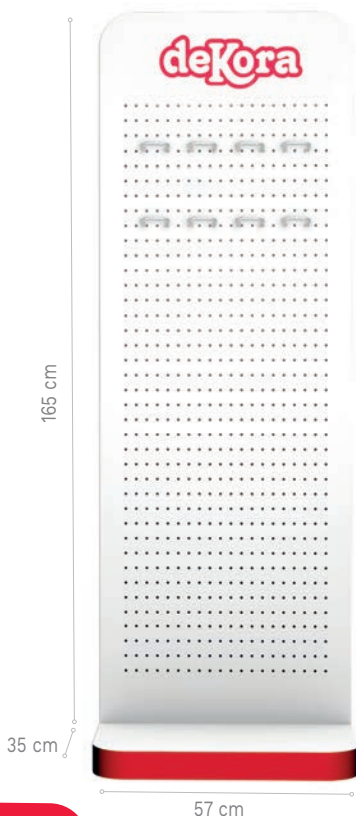

***No incluye ganchos**
Hooks are not included
Les crochets ne sont pas inclus
Não inclui ganchos
Non include ganci

707005*
EXPOSITOR METÁLICO SUELO
Metallic floor stand
Présentoir métallique
Expositor metálico
Espositore metallico da pavimento
57 x 35 x 165 cm

Ejemplo de presentación
Example of presentation
Exemple de présentation
Exemplo de apresentação
Esempio di presentazione

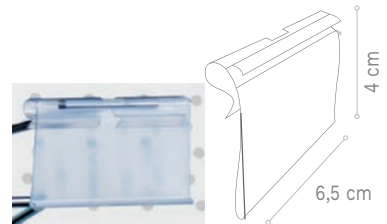

707001*
PORTA-PRECIOS DE PLÁSTICO PARA GANCHOS
Plastic price holders for hooks
- Porte-prix en plastique pour crochets
- Porta preços de plástico para ganchos - Portaprezzi di plastica per ganci
4 X 6,5 cm · 12 u.

EXPOSITORES - TRADE MARKETING

Stands · Présentoirs · Expositores · Espositori

EXPOSITOR METÁLICO METALLIC STAND

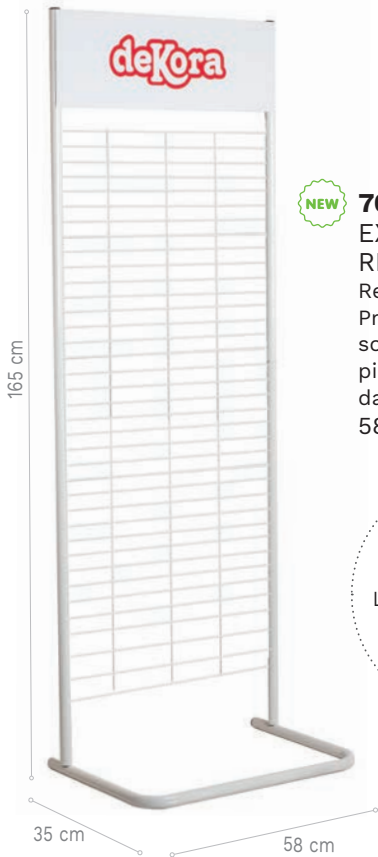

NEW 707014
EXPOSITOR METÁLICO REJILLA SUELO
 Retail metallic floor stand
 Présentoir métallique pour sol - Expositor metalico de piso - Espositore metallico da pavimento
 58 x 35 x 165 cm

***No incluye ganchos**
 Hooks are not included
 Les crochets ne sont pas inclus
 Não inclui ganchos
 Non include ganci



NEW 707010
 30 cm · 12 u.
NEW 707012
 20 cm · 12 u.

GANCHOS PORTA PRECIO METÁLICOS BLANCO EXPOSITOR REJILLA/ WHITE HOOK PRICE HOLDERS/ CROCHETS PORTE-PRIX METALLIQUES/ GANCHOS PORTA PREÇOS METALICOS/ PORTAPREZZO METALLICI
 * Compatible con / with / avec / compatível com / compatibile con Ref: 707014, 707009 & 707001



707001*
PORTA-PRECIOS DE PLÁSTICO PARA GANCHOS
 Plastic price holders for hooks - Porte-prix en plastique pour crochets - Porta preços de plástico para ganchos - Portaprezzi di plastica per ganci · 4 X 6,5 cm · 12 u.

CARTELAS PARA EXPOSITOR 707009
 Poster for stand ref. 707009
 Affiche pour présentoir ref. 707009
 Poster para expositor ref. 707009
 Poster per espositore rif. 707009



NEW 707016 - 68 x 19,5 cm



NEW 707013 - 68 x 19,5 cm



NEW 707015 - 68 X 19,5 cm



***No incluye ganchos**
 Hooks are not included
 Les crochets ne sont pas inclus
 Não inclui ganchos
 Non include ganci

NEW 707009
EXPOSITOR METÁLICO REJILLA SOBREMESA
 Retail metallic desk stand / Présentoir métallique pour comptoir / Expositor metalico de sobremesa / Espositore metallico da tavolo

EXPOSITORES - TRADE MARKETING

Stands · Présentoirs · Expositores · Espositori

EXPOSITORES CARTÓN SOBREMESA CARDBOARD DESK STAND



*** Base con separador regulable**

The base includes an adjustable divider - Base avec séparation mobile et réglable - Base com separador regulável - Base con separatore regolabile.

Ejemplo de presentación
Example of presentation
Exemple de présentation
Exemplo de apresentação
Esempio di presentazione

***No incluye ganchos**

Hooks are not included
Les crochets ne sont pas inclus
Não inclui ganchos
Non include ganci

708006 *

EXPOSITOR CARTÓN SOBREMESA

Cardboard desk stand - Présentoir de comptoir en carton - Expositor cartão sobremesa - Espositore di cartone da tavolo

59,5 x 23 x 76,5 cm

20 cm ·  20 u.



708005

GANCHOS DE PLÁSTICO

Plastic hooks - Crochets en plastique
Ganci di plastica

20 cm ·  20 u.



707007

EXPOSITOR CARTÓN SOBREMESA PARA DISCOS

Cardboard discs desk stand Présentoir de comptoir pour disques - Expositor em cartão para discos - Espositore di cartone da tavolo per dischi

41,7 x 31 x 70,5 cm

Ejemplo de presentación
Example of presentation
Exemple de présentation
Exemplo de apresentação
Esempio di presentazione

EXPOSITORES - TRADE MARKETING

Stands · Présentoirs · Expositores · Espositori

EXPOSITORES CARTÓN SUELO CARDBOARD FLOORSTAND

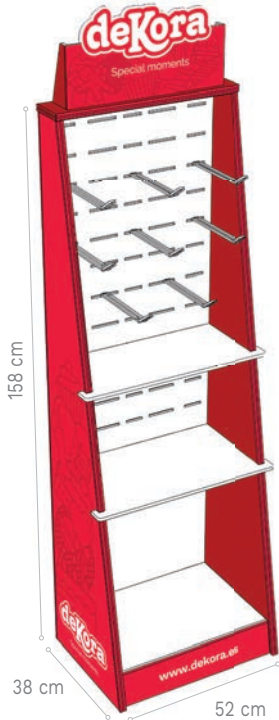

Ejemplo de presentación
Example of presentation
Exemple de présentation
Exemplo de apresentação
Esempio di presentazione

708007 *

EXPOSITOR CARTÓN SUELO

Cardboard floorstand - Présentoir carton

Expositor cartão - Espositore di cartone da pavimento

52 x 38 x 179,5 cm

* Incluye 2 bandejas - 2 trays included - Inclus 2 plateaux - Contem 2 bandejas. - Include 2 separatori

* BANDEJAS CON SEPARADORES REGULABLES -The removable tray allows to expand the room for hooks. Tray include adjustable dividers - Le plateau mobile peut être retiré et permet d'avoir plus d'espace pour les crochets. Plateaux avec séparateurs réglables - A bandeja se desmonta permitindo ampliar mais espaço para mais ganchos. Bandejas com separadores reguláveis - Vassoio con separatori regolabili.

***No incluye ganchos**

Hooks are not included
Les crochets ne sont pas inclus
Não inclui ganchos
Non include ganci



708005

GANCHOS DE PLÁSTICO

Plastic hooks - Crochets en plastique

Ganci di plastica

20 cm ·  20 u.

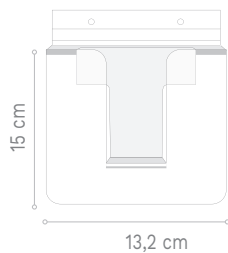

707002

PORTAFOLLETOS PVC

Brochure holder PVC - Porte documents PVC

Porta folheto PVC - Porta-depliant in PVC

15 x 13,2 cm (A6) ·  1 u.



706002

TIRA PORTAPRODUCTO PLÁSTICO

Plastic clip strip - Clip strip plastique - Clip strip plastico -

Profilo porta prodotto in plastica

60 x 4 cm ·  1 u.

EXPOSITORES - TRADE MARKETING

Stands · Présentoirs · Expositores · Espositori

EXPOSITORES CARTÓN SUELO CARDBOARD FLOORSTAND



706006

EXPOSITOR CARTÓN

Cardboard floor stand Présentoir en carton

Expositor cartão

Espositore di cartone

56 x 28,3 x 180 cm

Ejemplo de presentación
Example of presentation
Exemple de présentation
Exemplo de apresentação
Esempio di presentazione



706004*

EXPOSITOR CARTÓN

Cardboard floor stand

Présentoir en carton

Expositor cartão

Espositore di cartone

57 x 37 x 181 cm

*** Expositor con bandejas de base microperforada.**

- Stand with precut holes in the trays.

- Présentoir avec plateaux de base microperforée.

- Expositor com bandejas de base microperfurada.

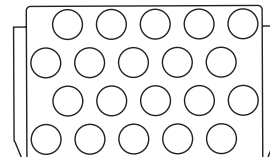

Ejemplo de presentación
Example of presentation
Exemple de présentation
Exemplo de apresentação
Esempio di presentazione

EXPOSITORES - TRADE MARKETING

Stands · Présentoirs · Expositores · Espositori

EXPOSITORES CARTÓN CARDBOARD STAND



706003
EXPOSITOR CARTÓN 1/8 PALLET
1/8 pallet cardboard floor stand - Présentoir en carton 1/8 palette- Expositor cartão 1/8 paleta - Espositore di cartone 1/8 pallet 39,5 x 30 x 177 cm

ABIERTO - Open
Ouvert - Aberto - Aperto



CERRADO - Closed
Femé - Fechado - Chiuso



502047*
EXPOSITOR CARTÓN
Cardboard stand - Présentoir en carton - Expositor em cartão - Espositore di cartone 60 x 40 x 134 cm

Ejemplo de presentación
Example of presentation
Exemple de présentation
Exemplo de apresentação
Esemplio di presentazione

*** Incluye 2 bandejas**
2 trays included
Inclus 2 plateaux
Contem 2 bandejas
Include 2 separatori



Ejemplo de presentación - Example of presentation - Exemple de présentation Exemplo de apresentação - Esemplio di presentazione

707004
TIRA DE LINEAL

Bande de lineaire - Tira de lineal - Profilo lineare
500 x 3,8 cm · Bobina - Reel - Bobine - Rolo - Bobina 1 u.



707003
STOPPERS PLV
15 x 28 cm · 1 u.



Ejemplo de presentación - Example of presentation
Exemple de présentation Exemplo de apresentação
Esemplio di presentazione

Consulte con su delegado de ventas - Consult your sales representative - Consultez votre délégué commercial
Consulte seu delegado de vendas - Consulenza con il proprio rappresentante di vendite

SÍGUENOS FOLLOW US



/@dekorainnova



/dekorainnova



/dekorainnova



/dekorainnova



/dekorainnova



1. SPRAYS base alcohol

- A. Efecto Perlado
- B. Efecto Metalizado
- C. Efecto Neutro o Aerógrafo

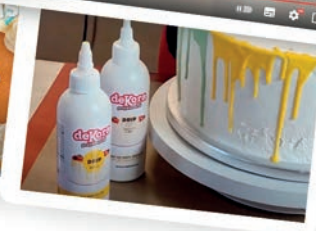
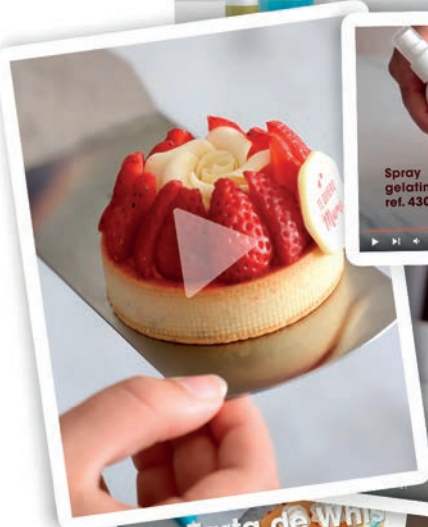

Únete a nuestra comunidad y no te pierdas **novedades, recetas y tutoriales**. Déjate inspirar por nuestras propuestas.

Join our community and don't miss **news, recipes and tutorials**. Let yourself be inspired by our proposals.

Rejoignez notre communauté et ne manquez pas les **actualités, les recettes et les tutoriels**. Laissez-vous inspirer par nos propositions.

Junte-se à nossa comunidade e não perca **novedades, receitas e tutoriais**. Deixe-se inspirar pelas nossas propostas.

Unisciti alla nostra community e non perdere **novità, ricette e tutorial**. Lasciati ispirare dalle nostre proposte.

deKora

dekora.es





dekora.es



Dekora Innova S.A.U.
Pol. Ind. Las Atalayas • c/Florín, Parcela 30-39
Buzón 20095 • 03114 Alicante (Spain)
Tel. (+34) 965 94 30 33

www.dekora.es



[/dekorainnova/](https://www.facebook.com/dekorainnova/)



[company/dekora/](https://www.linkedin.com/company/dekora/)



[dekorainnova](https://www.pinterest.com/dekorainnova/)



[/marketingdekora](https://www.instagram.com/marketingdekora/)



[/dekorainnova](https://www.youtube.com/dekorainnova/)



[/dekorainnova](https://www.tiktok.com/dekorainnova/)